

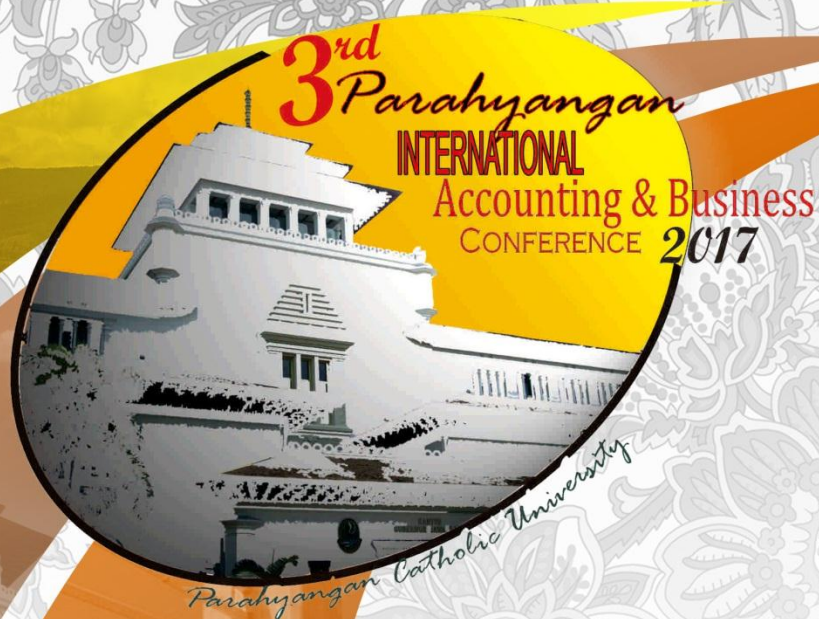

PROCEEDING



3rd PARAHYANGAN INTERNATIONAL ACCOUNTING AND BUSINESS CONFERENCE

“THE FUTURE OF ACCOUNTING AND BUSINESS IN RAPID DEVELOPMENT OF INFORMATION TECHNOLOGY”

THURSDAY - FRIDAY, MAY 4 - 5, 2017
SHERATON HOTEL, BANDUNG, WEST JAVA, INDONESIA

**ACCOUNTING DEPARTMENT, FACULTY OF ECONOMICS
PARAHYANGAN CATHOLIC UNIVERSITY**

Supported by:



Official Partners:



IKATAN AKUNTAN INDONESIA
WILAYAH JAWA BARAT

PROCEEDING
3rd PARAHYANGAN ACCOUNTING AND
BUSINESS CONFERENCE
(3rd PIABC)

Authors:

Call for Paper Participants of the 3rd PIABC

Publisher:

Accounting Department, Faculty of Economics, Parahyangan Catholic
University

Jalan Ciumbuleuit 94, Bandung, West Java, Indonesia

Tel: +62222041964

Fax: +62222042571

The 3rd Parahyangan International Accounting and Business Conference

Published by:

Accounting Department, Faculty of Economics, Parahyangan Catholic University
PIABC (Parahyangan International Accounting and Business Conference)

Copyright © PIABC 2017

All rights reserved. No part of this work may be reproduced in any form or by any means without written permission from Accounting Department, Faculty of Economics, Parahyangan Catholic University

Reviewers:

- Prof. Dr. Hamfri Djajadikerta, Drs., Ak., M.M. (Parahyangan Catholic University)
- Prof. Indra Wijaya Kusuma M.B.A., Ph.D. (Gajah Mada University)
- Prof. Dr. Sukrisno Agoes, Ak., M.M., CPA., CA. (Tarumanagara University)
- Prof. Dr. Unti Ludigdo, Ak. (Brawijaya University)
- Prof. Dr. Marcelia Susan Karnadi, SE., MSIE. (Maranatha Christian University)
- Prof. Meine Pieter van Dijk, PhD. (UNESCO-IHE Institute)
- Prof. Jeong-Dong Lee, B.S., M.S., Ph.D. (Seoul National University)
- Prof. Madya Mahfudzah Mohamed, B.A., M.A. (University Teknologi MARA - UiTM)
- Agus Gunawan, Ph.D. (Parahyangan Catholic University)
- Dr. Amelia Setiawan, SE., M.Ak., Ak., CISA. (Parahyangan Catholic University)
- Ani Wilujeng Suryani, S.E, M. Acctg.Fin., Ph.D.(c) (University of South Australia)
- Dr. Bambang Wiharto (University of Indonesia)
- Dr. Budiana Gomulia, Dra., M.Si. (Parahyangan Catholic University)
- Dr. Budi Frensidy, S.E., M.Com. (University of Indonesia)
- Dr. Chaerul D. Djakman, S.E., Ak., M.B.A. (University of Indonesia)
- Dr. Elizabeth Tiur M., Dra., Ak., M.Si. (Parahyangan Catholic University)
- Dr. F. X. Supriyono, Drs., M.M. (Parahyangan Catholic University)
- Dr. rer. pol. Hamzah Ritchie, Ak., CA. (Padjadjaran University)
- Hilda Masniaritta Pohan, Ph.D. (Parahyangan Catholic University)
- Iman Harymawan, S.E., M.B.A., Ph.D. (Airlangga University)
- Dr. Istiharini, S.E., M.M. (Parahyangan Catholic University)
- Ivantia S. Mokoginta, Ph.D. (Parahyangan Catholic University)
- Januarita Hendrani, Dra., M.A., Ph.D. (Parahyangan Catholic University)
- Dr. Jol Stoffers, M.B.A. (Zuyd University)
- Dr. Judith F. Pattiwael, Dra., MT. (Parahyangan Catholic University)
- Dr. Law Siang Hook (University Putra Malaysia)
- Dr. Ludovicus Sensi Wondabio, CPA. (University of Indonesia)
- Dr. Majidah, S.E., M.Si. (Telkom University)
- Dr. Maria Widyarini (Parahyangan Catholic University)
- Dr. Miryam B. L Wijaya, Dra., M.A. (Parahyangan Catholic University)
- Dr. Paulina Permatasari, S.E., M.Ak., CMA., CSRS., CSRA. (Parahyangan Catholic University)
- Sandra Sunanto, Ph.D. (Parahyangan Catholic University)
- Suyanto, S.E., M.Ec.Dev., Ph.D. (University of Surabaya)
- Dr. Sofian Soegioko, M.M. (Unika Atma Jaya Jakarta)
- Dr. Sylvia Fettry E.M., S.E., S.H., M.Si., Ak. (Parahyangan Catholic University)
- Dr. Theresia Gunawan (Parahyangan Catholic University)
- Dr. Urip Santoso (Parahyangan Catholic University)
- Dr. Wing Wahyu Winarno, MAFIS, CA, Ak. (STIE YKPN Yogyakarta)
- Yudho Giri Suchahyo, Ph.D, CISA, CISM, CEP-PM, CSRS. (University of Indonesia)

Editor:

Dr. Amelia Setiawan, SE., M.Ak., Ak., CISA.
Amelia Limijaya, SE., M.Acc.Fin.

Cover Design:

Christian Adhi Natanegara

Printed by:

Accounting Department, Faculty of Economics, Parahyangan Catholic University
Jalan Ciumbuleuit 94, Bandung, West Java, Indonesia
Tel: +62222041964 Fax: +62222042571

GREETINGS

At this opportunity, we are very grateful that the committee has successfully managed to organize the 3rd Parahyangan International Accounting and Business Conference 2017 and thus this proceeding can be published accordingly.

We are very thankful to the Association of Chartered Certified Accountants (ACCA), especially ACCA Indonesia, who has been our co-host in organizing this event. Your help, support and contribution is highly appreciated. We look forward to having a long-lasting relationship and cooperation with ACCA.

The conference carries the theme “The Future of Accounting and Business in Rapid Development of Information Technology”. As we are all aware of, globalization has encouraged all parties to adapt to the changing situation in order to keep their existence. Those who are able to adjust themselves to the rapid changes that are happening nowadays will be left behind or even will not be able to keep the business going into the future. In contrast, those who are adaptive and have the ability to utilize opportunities in the marketplace will become pioneers in the competition.

The rapid development of information technology is inseparable from the globalization itself. Faster information processing, easier access to information and lower information processing costs have caused the mass increase in the availability of information. This should be considered as an opportunity instead of a threat.

Accounting is an important factor for organizations to remain competitive in the globalization era. Technology also plays a major role in transforming the role of accounting in this era. What used to be a bookkeeping function has now evolved into an engine to achieve competitive advantage. This transforming role of accounting in the globalization era will certainly affect the business world. This warrants further research or study by academicians or practitioners so that we can understand and better prepare ourselves to face the dynamic world we are now living in. The fast-paced advancement of technology can also become an interesting area to be analyzed to predict how far the role of accounting is in the business world will change in the future.

We are very thankful to all parties who have supported and made this event possible, to name a few: all the committee members including our students, partners, sponsors, reviewers, speakers, paper authors, presenters, and to all other parties that cannot be mentioned one by one. To all paper authors, we believe that your research result will bring contributions to each respective field of knowledge.

We apologize for any inconvenience that might occur during the event. Hopefully the proceedings would contribute to the advancement of knowledge in relevant fields.

Best regards,
Linda Damajanti Tanumihardja
3rd PIABC Head of Committee



TABLE OF CONTENTS

GREETINGS	iii
TABLE OF CONTENTS.....	iv
COMMON IDIOSYNCRATIC VOLATILITY IN INDONESIA	1
COMPARISON OF USER EXPERIENCE ON GO-JEK AND GRAB MOBILE APPS (A STUDY ON PT. GO-JEK AND PT. GRAB INDONESIA CONSUMERS IN DKI JAKARTA).....	14
“WHAT’S WRONG WITH A PHENOMENON UNDERPRICING?”	31
MANAGEMENT OWNERSHIP AND STOCK PRICE INFORMATIVENESS IN INDONESIA STOCK MARKET.....	48
THE EFFECT OF MUDHARABAH AND MUSYARAKAH ON THE PROFITABILITY OF ISLAMIC BANKS.....	69
FOREIGN HOLDING COMPOSITION AND EXCHANGE RATES IN INDONESIA	85
E-PROCUREMENT IMPLEMENTATION AND BUDGET ABSORPTION IN INDONESIAN LOCAL GOVERNMENT.....	115
ORGANIZATIONAL LEARNING AS INTERVENING VARIABLE ON ASSOCIATION OF IT COMPETENCE TO PERFORMANCE OF PUBLIC SECTOR ENTITIES: AN EMPIRICAL STUDY AT SIMDA OF BOGOR LOCAL GOVERNMENT.....	137
RESPONSIBILITY DESIGN MODEL & FINANCIAL DISCLOSURE BASED ON WEB-ICT WITH INDEX FULL DISCLOSURE METHOD FOR GOOD GOVERNANCE GOVERNMENT IN INDONESIA REGENCY AND CITY (EMPIRICAL STUDY ON ENTIRE LOCAL GOVERNMENT REGENCY AND CITY IN INDONESIA)	161
MANAGEMENT SUPPORT AND INTERNAL AUDITOR COMPETENCY MATTER: EMPIRICAL STUDY OF INTERNAL AUDITOR IN INDONESIAN PUBLIC SECTOR.....	185



THE MODERATING EFFECT OF ECONOMIC GROWTH ABILITY OF FINANCIAL FACTORS ON THE IMPLEMENTATION OF E-GOVERNMENT	202
INVESTIGATING COMPETITIVE ADVANTAGE OF PT SIANTAR TOP, TBK: CASE STUDY USING FUNCTIONAL BUSINESS ANALYSIS	213
BUSINESS PERFORMANCE ANALYSIS OF PT MAS MURNI INDONESIA, TBK: CASE STUDY USING FUNCTIONAL BUSINESS ANALYSIS	236
THE IMPACT OF STRATEGIC PLANNING IMPLEMENTATION ON NON-PROFIT ORGANIZATION'S PERFORMANCE EFFECTIVENESS	256
THE INFLUENCES OF ENTREPRENEURIAL ORIENTATION AND ALLIANCE LEARNING PROCESS ON STRATEGIC ALLIANCE PERFORMANCE OF INDONESIA CONSTRUCTION COMPANIES.....	277
THE EFFECT OF INNOVATION TO ORGANIZATION PERFORMANCE AT CULINARY INDUSTRY ON BRAGA DISTRICT.....	302
STRATEGIC ADVANTAGES OF PT WILLMAR CAHAYA INDONESIA, TBK: CASE STUDY USING SWOT ANALYSIS.....	315
IMPROVEMENT ON DELIVERY SERVICE IN DROPSHIPPER COMPANY: CASE OF AQUARIST FARM.....	333
THE INFLUENCE OF BUDGETARY COMMITMENT ON MANAGERIAL PERFORMANCE: PARTICIPATIVE BUDGETING AS AN INTERVENING VARIABLE	343
FACTORING EMPLOYEE ENGAGEMENT OF FULL TIME LECTURERS.....	361
MOTIVES FOR ENGAGING CORPORATE SOCIAL RESPONSIBILITY PROGRAM.....	384
THE INFLUENCE OF LEADERSHIP STYLE AND ORGANIZATIONAL CULTURE IN THE IMPLEMENTATION OF RISK MANAGEMENT.....	405
PUBLIC GOVERNANCE AND CORPORATE ETHICS: A CROSS NATIONAL ANALYSIS.....	422



SIMAKU®-SEKOLAH: THE IMPLEMENTATION OF MANAGEMENT INFORMATION SYSTEMS AND ACCOUNTING FOR SCHOOL SOFTWARE USING WEB-BASED APPLICATIONS TO ACHIEVE GOOD SCHOOL GOVERNANCE.....	442
THE ROLES OF GOOGLE GIFT CARD AND GOOGLE WALLET IN ACCOUNTING AND BUSINESS	456
THE ROLE OF XBRL USE TO THE QUALITY OF ELECTRONIC FINANCIAL STATEMENTS AND COMPANIES RISK.....	468
ANALYZE TO THE ROLE EXTENSIBLE BUSINESS REPORTING LANGUAGE (XBRL) TO IMPROVE THE ACCURACY OF TAX REPORT	477
MEANING OF SENTIMENT ANALYSIS FOR COMPANIES	487
COMPETITIVE ANALYSIS MODEL IN GARMENTS INDUSTRY: CASE STUDY OF PT. PAN BROTHERS, TBK.....	499
INDUCTIVE REASONING IN MARKETING RESEARCH TO RESPOND THE FUTURE MARKET CHALLENGES	514
MARKETING STRATEGY ANALYSIS TO INCREASE THE GROWTH OF OLAMITA RESTO	521
PREMIUM FRESH PRODUCE MARKETING SUCCESS FACTORS THROUGH PRODUCT QUALITY DIMENSIONS AS CUSTOMER DRIVING FORCES: A CASE STUDY OF FRUIT SPECIALTY STORE PRODUCT DISPLAY OPTIMIZATION IN BANDUNG.....	545
SHARIA MARKETING ANALYSIS IN NOOR HOTEL BANDUNG	560
THE AMENDMENT OF IAS 41: A SOLUTION FOR PLANTATIONS INDUSTRY IN INDONESIA?.....	577
AUDITOR SWITCHING’S FACTORS: THE ANALYSIS ON AUDIT DELAY, CLIENT SIZE, AND AUDIT COMMITTEE CHANGES	589
DO COMPANY’S ATTRIBUTES AND AUDIT RELATED FACTORS AFFECT TIMELINESS OF FINANCIAL REPORTING?	608



EARNINGS BENCHMARKS AND TIMELINESS OF AUDIT REPORTS: CORPORATE GOVERNANCE MECHANISM AS MODERATING VARIABLE	627
THE IMPACT OF WORK-FAMILY CONFLICT TOWARD JOB PERFORMANCE – THE CASE OF EXTERNAL AUDITOR	641
OIL PRICE AND BANKRUPTCY PROBABILITY OF OIL AND GAS COMPANIES (STUDIES IN 3 ASIA-PACIFIC COUNTRIES).....	664
PREDICTING GREEN PURCHASE INTENTION OF GENERATION Y: AN EMPIRICAL STUDY IN INDONESIA.....	682
SOCIAL AND ENVIRONMENTAL ACCOUNTING AND RELEVANCE VALUE: AN ANALYSIS IN LATIN AMERICA	709
THE READINESS OF INTEGRATED REPORTING (IR) IMPLEMENTATION ON COMPANIES PUBLISHING SUSTAINABILITY REPORT IN 2015	721
CREATIVE CITY: ANALYSIS OF BANDUNG CREATIVE CITY INDICATORS	737



COMMON IDIOSYNCRATIC VOLATILITY IN INDONESIA

Pratiwi Noviayanti

Zaafri Husodo

Graduate School of Management, Faculty of Economics and Business, Universitas Indonesia,
Depok, Indonesia

pratiwinoviayanti@gmail.com

Abstract

This research aims to examine a factor structure in idiosyncratic volatility and how the shock from common idiosyncratic volatility (CIV) is priced in Indonesia. This study is not only to determine the effect of idiosyncratic volatility, but also to know how the factor structure of idiosyncratic volatility and the exposure of CIV shock on firm. As the research on emerging markets, especially Indonesia, is still yet recorded in literature regarding common idiosyncratic volatility. Idiosyncratic volatility in this study is calculated as variance of residuals from market model regression, and estimated using EGARCH method because of the nature of volatility that has time varying behavior. The study found that there is no significant results in CIV-beta investment strategy and show that changes in CIV is not priced as common factor that explain stock returns in Indonesia.

Keywords: firm volatility, idiosyncratic risk, cross-section of stock returns, emerging market

JEL Classification: B59

INTRODUCTION

Risk in investment is one of the most important thing that should be known and be considered by investor to get expected return. The theory between risk and return is commonly known by capital market investor, higher risk higher return (positive risk premium). There is assumption that investor is risk averse, this a nature to avoid the risk. This nature will induce investors to invest their money in assets that have no risk (risk free assets) if the risk premium in risky assets have zero value. That is why positive risk premium theory



is used to induce investors with risk averse to invest their money in risky assets rather than risk free assets.

At first, investor just look at market risk that has systematically effect (systematic risk), meanwhile risk that come from individual stock is not priced because it has no effect to other stocks and market systematically (unsystematic risk). Some of financial experts argued that risks involved with stocks or assets can be minimized by portfolio diversification so the total risk can close to zero. Unfortunately diversify a portfolio is not easy and not all investors have diversified portfolio.

This unsystematic risks involve with stocks or assets is known as idiosyncratic risks. Although this risks can be eliminated or minimized by diversification, there are always risks that cannot be diversified because of market imperfection, then there is always a compensation for investors that hold undiversified assets. Idiosyncratic risks have become center of interest some of asset pricing researchers and recently has been studied in the form of volatility called idiosyncratic volatility (IVOL).

There are some empirical studies about idiosyncratic risks, unfortunately the results of those studies is still inconsistent and become puzzle until now, even though most the results of studies indicate the importance of idiosyncratic risk. Some researchers such Xu & Malkiel (2003), Goyal & Santa-Clara (2003), Jiang & Lee (2006), Fu (2009), Huang et al. (2010), and Miffre et al. (2013) contended that there is positive relationship between IVOL and stock returns. Meanwhile Ang et al. (2006) and Guo & Savickas (2006) contended that there is negative relationship, the others even concluded that there is no significant relationship between IVOL and stock returns as reported by Bali & Cakici (2008) and Bradrania et al. (2015).

Even though there are some inconsistency in some results, still that results show that idiosyncratic risk is one of important factor in asset pricing. The differences in effects can be caused by several things such as data frequency and treatment of the data (Khovansky & Zhylyevskyy, 2013), or the proxy used as idiosyncratic risk (Vozlyublennaiia, 2012). Recent study by Herskovic et al. (2016) reported the commonality in IVOL can explain cross-section stock return by measuring the exposure of stock return against common idiosyncratic volatility.



Study of idiosyncratic volatility mostly done in developed markets, study in emerging markets is still not many seen in the literature. Nartea et al (2011) pointed that it is not equal if generalizing the results about idiosyncratic volatility in developed and emerging markets. Their study found positive relation between IVOL and stock return in four country in South East Asia, Singapore, Thailand, Malaysia, and Indonesia. This result give some evidence that IVOL's effect on stock return in some of emerging markets in Asia and even developed markets such as Singapore give different sign of effect from evidence in US (United States).

The aim of this study is to find the exposure of firm on common idiosyncratic volatility (CIV). The study about CIV recently done on developed markets (US), this CIV term was introduced by Herskovic et al. (2016). CIV is a proxy of all firms idiosyncratic volatility by averaging IVOL across firms, this was done by Herskovic et al. (2016) because of their found on synchronized IVOL of US firms. Therefore, this study will explore the exposure of change in CIV (CIV-shocks) in affecting average stock returns, whether the exposure of CIV-shocks has the same effect as the effect in developed markets. Another aim of this study is to find if the exposure will be different if the proxy of IVOL used on this research is expected IVOL rather than realized or lagged IVOL.

LITERATURE STUDY

Idiosyncratic Risk

Malkiel and Xu (2002) showed that the volatility of individual stock increase over time. Their study also pointed that idiosyncratic volatility had an effect on stock return with condition that idiosyncratic volatility can affect the stock return if all investors do not have diversified portfolio.

Goyal and Santa-Clara (2003) reported the positive relation between idiosyncratic risk, that had average stock risk as a proxy, and return of stocks. They explained that investor hold the non-traded assets that increase risk of investor so then increase the investors' expectation for bigger return as the compensation.

Ang et al. (2006, 2009) found that stock with high idiosyncratic volatility had low average return, this the opposite of the existing theory that pointed the higher the risk the



higher the return. His study not only study the idiosyncratic risk but also aggregate volatility risk, or market risk, the result showed the bigger the sensitivity against the volatility of risk, gave lower average return on the portfolio that sorted on idiosyncratic volatility. Based on the result, they contended that the cause is the sensitivity of stock on the aggregate volatility risk. They also argued that previous study did not examine idiosyncratic volatility on the firm level or did not sorting portfolio based on idiosyncratic volatility (IVOL). Guo & Savickas (2006) also found the negative relationship between IVOL and stock return, same conclusion with Ang et al. (2006, 2009). The difference of both study lie on the positive relation with aggregate volatility risk.

However Bali & Cakici (2008) did not found a significant relationship between idiosyncratic risk and stock return. Even after verified the weakness on the study of Goyal & Santa-Clara (2003) in the previous study, they did not find any significant relation between idiosyncratic risk and the stock return on the portfolio measured with value weighted (Bali et al., 2005).

Expected Idiosyncratic Volatility & Common Idiosyncratic Volatility

Fu (2009) used EGARCH model to estimate the expected idiosyncratic volatility and found a positive relations between IVOL and stock return. He argued the IVOL that usually used in the previous study is realized IVOL and not the expected IVOL that has time series property or volatile over time. This result contradict with conclusion from Ang et al. (2006, 2009) that showed the negative relation. Fu (2009) argued that used of the expected IVOL should on the same period with the expected return not on the one lagged month period, and the negative relation on the conclusion of Ang et al. (2006, 2009) can be caused by the effect of return reversal Huang et al. (2010).

Miffre et al. (2013) indicated that investor demand for additional return when holding undiversified portfolio. Their study explained idiosyncratic volatility on portfolio sorted on size and value weighted, the result still robust even after controlling some factors based on size, value, past performance, liquidity and total volatility.

Bradrania et al. (2015) explained that even after controlling liquidity cost, which suspected as the cause of the positive relation between idiosyncratic risk and return, the study



was not found any significant relation. This result more or less similar with the result from Bali et al. (2005), the difference lie on the use of portfolio measurement, when Bradrania et al. (2015) use equally weighted and Bali et al. (2005) use value weighted.

One of the latest study about idiosyncratic volatility (IVOL) found that IVOL of US firms are synchronized. This research was done by Herskovic et al. (2016) revealed the commonality on the factor structure of IVOL if there is a synchronization between firms' IVOL and explained for the existence of common idiosyncratic volatility (CIV) between firms. Their study showed that CIV is priced as one of assets pricing factor in US, the lower the exposure on CIV-shocks (negative CIV-beta) the higher the stock return rather than higher CIV-beta. More than evidence on stock return, CIV has relation with household labor income.

Idiosyncratic Volatility in Emerging Markets

Nartea et al. (2011) studied the relation of IVOL and stock return on South East Asian emerging markets, such as Malaysia, Singapore, Thailand, Indonesia, and Philippines. The study verify positive relation between idiosyncratic risk and stock return, using standard deviation of residual on Fama-French regression as idiosyncratic volatility. However Nartea et al. (2013) found new evidence using stock data from China, they found negative relation between idiosyncratic risk and stock return on emerging market. They argued that IVOL in China is periodic-specific coincide with regime shift and structural market reforms.

Similar with Ang et al. (2006, 2009), according to Murhadi (2013) relation of IVOL and stock return in Indonesia was a significant negative relation. He argued that the result give implication that investors tend to focus to a firm with lower risk when they cannot form a diversified portfolio to minimized the effect of idiosyncratic risk. Another evidence was not found the significancy of relationship between idiosyncratic volatility and average stock returns in Indonesia (Yunengsih and Husodo, 2014).



METHODS

Data

Stock price data that used on this study consists of daily and monthly data frequency on firms that is registered on Jakarta Stock Exchange and data of Indonesia stock market index. The risk free rate use SPN (Surat Perbendaharaan Negara) or Treasury of Indonesian Government 3 month rate that has similar characteristics to US T-bill rate. Used data is secondary data with a sample of non-finance firms and still active in Indonesia Stock Exchange. The sample period is from January 2001-August 2016, this sample is taken to find how the exposure on CIV affecting stock returns in a quite long period of time, rather than super long period time that usually used in analysing developed markets.

Research Method

Expected Idiosyncratic Volatility

Idiosyncratic volatility (IVOL) that is estimated on this study is an IVOL that varies over time, according to Fu (2009) expected IVOL varies and volatile over time so it can produce positive relation between IVOL and stock returns. Expected IVOL estimate use EGARCH (p,q) method suggested by Fu (2009).

$$(r_i - r_f)_t = \alpha + \beta_i (R_m - r_f)_t + \varepsilon_{i,t} \quad (3.1)$$

$$\varepsilon_{i,t} \sim N(0, \sigma_{i,t}^2)$$

$$\ln \sigma_{i,t}^2 = \alpha_i + \beta_i + \gamma_i \ln \sigma_{i,t-k}^2 + \lambda_i \left\{ \theta (\varepsilon_{i,t-k} / \sigma_{i,t-k}) + \gamma [|\varepsilon_{i,t-k} / \sigma_{i,t-k}| - (2\pi)^{-1/2}] \right\} \quad (3.2)$$

Idiosyncratic volatility that is estimated using model above is variance of residual from market model regression. Residual $\varepsilon_{i,t}$ is assumed to be normal with the mean of zero and conditional variance $\sigma_{i,t}^2$. This model has several advantage than GARCH model, that is do not restrict parameter values to avoid negative variance and capture asymmetry effect on conditional volatility (Brooks, 2014). Another parameter that will be measured is market volatility (MV) to consider its effect on firms' stock. This MV will be analysed to see the exposure of firms' stock return on changes in MV.



Common Idiosyncratic Volatility

After obtaining IVOL, CIV (Common Idiosyncratic Volatility) is calculated as average of IVOL across the firms. Then obtaining CIV-beta and MV-beta from regressing excess return on CIV-shocks (changes of CIV per month) and MV-shocks (changes of MV per month) with 60 month rolling window regression.

$$(r_i - r_f)_t = \alpha + \beta_{CIV} \Delta CIV_{st} + \beta_{MV} \Delta MV_{st} + \varepsilon_{i,t} \quad (3.3)$$

Model (3) explain the effect of CIV-shocks on excess return $(R_i - r_f)_t$ for stock i on period t . ΔCIV_{st} is CIV-shocks on period t . Meanwhile ΔMV_{st} is MV-shocks on period t . Parameter β_{CIV} is the exposure of firms on changes in CIV or called CIV-beta and β_{MV} is the exposure of firms on changes in MV or called MV-beta. This betas are used on sorting portfolio each month to find average return on portfolio quintiles.

RESULTS

Idiosyncratic volatility is described as firm level volatility that is considered not important in determining stock return and can be minimized or neutralized by portfolio diversification. In fact, in some countries, specifically in developed markets such as US, idiosyncratic volatility is proved to be matters either with significant negative or positive relations. This study will attempt to prove if exposure on changes in CIV (common idiosyncratic volatility) is matter and can be priced in Indonesia. The table below describe the descriptive statistics of variables used in this study.

Table 1. Descriptive Statistics of Variables

	Xret	CIVS	MVS	CIV	MV
Mean	0.016476	5.77E-05	-5.4E-05	0.160646	0.085517
Std Deviation	0.194321	0.009227	0.011975	0.011454	0.025875
Median	-0.00349	-0.00031	-0.0031	0.158462	0.07664
Max	5.471562	0.023555	0.091287	0.195157	0.208943
Min	-0.72272	-0.02717	-0.0221	0.139108	0.058208
Skewness	5.162771	-0.07263	3.984328	0.742897	2.095406

Source: Research analysis



Descriptive statistics of variables can be seen on table above, the analysis give the picture of mean, standard deviation, maximum and minimum value, and skewness of variables in period of analysis. The mean for monthly stock return in excess of risk free rate return is around 1,7% per month. The independent variable for regression is CIVs (common idiosyncratic volatility-shocks) and MVs (market volatility-shocks), mean for CIVS is the average of monthly changes on CIV is around 0.00577% and the average of monthly changes on MV is around -0.0054% per month. The variables that had been used for analysis have positive skewness, except for CIVs that has negative skewness.

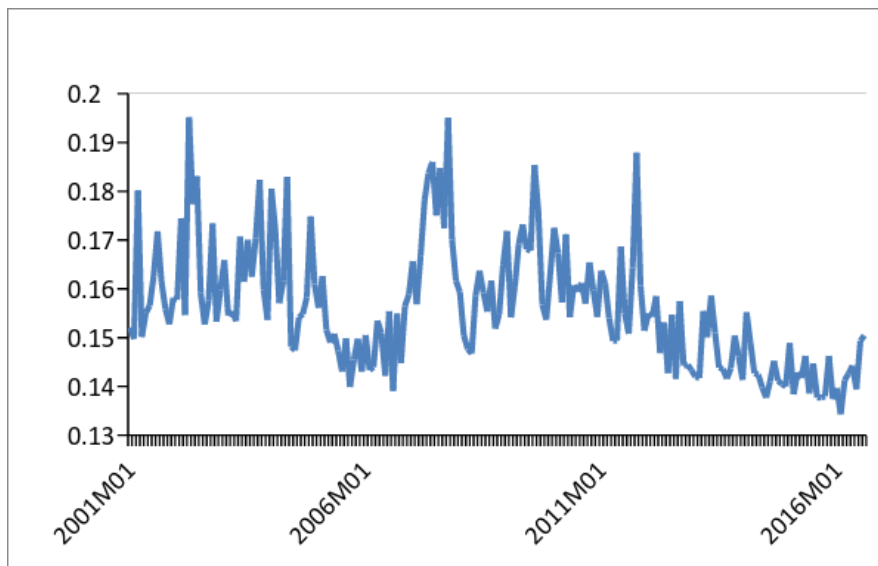

Figure 1. Common Idiosyncratic Volatility

Picture above show how the pattern of common idiosyncratic volatility in Indonesia on 15 years period. Overall the pattern do not show any trend, upward or downward trend, in firm level idiosyncratic volatility moves in Indonesia. The benefits of diversification can be implied by upward trend in idiosyncratic volatility that implies decreasing correlation among stocks as well. Decreasing correlation among stocks means portfolio diversification among stocks will be easier and give more benefits to investors (Campbell et al., 2001). Meanwhile the pattern of common idiosyncratic volatility in Indonesia do not show any increasing IVOL over time, that is show that portfolio diversification in Indonesia do not give many benefits to investors.

The CIV is used to examine the exposure of stock returns on changes of CIV, called CIV-beta. The beta was estimated by regressing return in excess of risk free rates on CIV-shocks and MV-shocks using 60 month rolling window regression to get CIV- and MV-beta each month. The estimated beta then used in sorting stocks into quintiles to form equally weighted portfolio.

Table 2 show the portfolio formed on CIV-beta with different methods of sorting. Panel A is portfolio formed with one way sort on CIV-beta. Meanwhile Panel B is one way sort on CIV-beta controlling of MV-beta, following steps from Herskovic et al. (2016) by collapsing double sorted portfolio on MV-beta and CIV-beta, and Panel C is double sort or two way sort on MV-beta and CIV-beta. This portfolio-based approach is the easiest way to interpret returns on feasible investment strategy, by sorting stocks into portfolio based on variables give a simple picture if the returns is increasing or decreasing on independent variables. The most feasible investment strategy that can be seen is the zero investment strategy that start with long in high CIV-beta and short in low CIV-beta.

Table 2. Portfolios formed on CIV-beta

Panel	CIV1	CIV2	CIV3	CIV4	CIV5	Q5-Q1	t(5-1)
A: One way sort on CIV-beta							
	25.835	22.083	17.401	15.754	18.565	-7.27	-0.1752
B: Sort on CIV-beta controlling for MV-beta							
	21.58	24.85	19.30	13.28	20.67	-0.91	-0.113
C: Double sorting on CIV-beta & MV-beta							
MV1	5.895	3.925	23.06	4.503	9.476	3.581	-0.064
MV2	19.479	17.222	9.87	24.584	25.199	5.721	-0.026
MV3	21.327	10.928	18.246	6.267	6.738	-14.589	-1.491
MV4	15.931	26.472	10.849	14.789	21.518	5.587	0.592
MV5	6.856	9.818	10.886	-4.186	22.87	16.015	0.429
Q5-Q1	0.961	5.893	-12.174	-8.689	13.395	-	-
t(5-1)	0.086	0.538	-1.424	-1.513	0.529	-	-

Source: Research analysis



Portfolio on Panel A with one way sort on CIV-beta show decreasing average returns in CIV-beta. The stocks on lowest CIV-beta (CIV1) give more returns than any stocks in other quintiles, meanwhile the lowest return is seen in the second highest CIV-beta (CIV4). Overall the results can say that the returns is decreasing in CIV-beta, this can be seen at the zero investment strategy (5-1) show the similar results showed in Herskovic et al. (2016), where the return of strategy is negative return which means that the lowest CIV-beta has higher return than highest CIV-beta portfolio. Similar results seen in Panel B, CIV-beta sorted portfolio controlling for MV-beta, even after controlling the exposure on market volatility.

This is similar results from Herskovic et al. (2016) with United States' IVOL, that has return's pattern monotonically decreasing in CIV-beta. Fu (2009) suggested that the patterns of return that monotonically increasing or decreasing across the IVOL portfolio were completely driven by small stocks with high idiosyncratic volatility. The results on Herskovic et al. (2016) may followed this suggestion, as they did not report robustness results that explained about group of small stocks. Even though similar, the significance on investment strategy do not show any significancy in both of the panels.

In panel C, the excess returns is double sorted on CIV-beta and MV-beta (5 by 5). These portfolios is the same portfolio with the one described for controlling MV-beta. The results is reversed version on two other panels, the zero investment strategy on CIV-beta is earning positive average returns within each MV-beta quintile, except the Q5-Q1 strategy in the third quintile of MV-beta that earned negative average return. The inconsistency of the results between panel on single and double sorting was clarified on the t-stat of the investment strategy that did not show any significancy. This results is different from what Herskovic et al. (2016) found, that there is reverse effect on zero investment (Q5-Q1) CIV-beta strategy and MV-beta strategy where the CIV-beta investment strategy has significant results and the MV-beta strategy was not significant.

Even though the study use expected IVOL to form the CIV, the results still show decreasing pattern (not monotonically) of return across CIV-beta portfolio, except for the double sorting portfolio, even if all of the investment strategy on portfolios were not



significant. This can be caused by return reversal from the previous month that has positive returns especially from small stocks that have high IVOL as argued by Fu (2009).

In case of Indonesia, investor may not see many benefits in diversify portfolio based on its IVOL moreover its exposure against changes in CIV as the there is no significancy on the investment strategy. Yunengsih and Husodo (2014) pointed that idiosyncratic volatility cannot predict stock return in Indonesia even in short or long periods. Even after using the EGARCH method for expected IVOL estimation, the exposure of idiosyncratic volatility did not have any significant effect on average stock returns. This results is in accordance to Bali & Cakici (2008) where found no significant evidence in the relation of return and idiosyncratic volatility. Indicating that CIV factor did not have the ability to explain stock returns associated with CIV-beta sorted portfolio in emerging markets such as Indonesia and not being considered by investors.

CONCLUSION

Even if the CIV is priced in the cross-section of stock returns in US as developed markets, the effect of CIV will not the same if the factor is analysed in emerging market as Indonesia. The results of study found that there is no significancy on CIV-beta (exposure of changes in CIV) investment strategy even after controlling on exposure of market volatility-beta. This result conclude that changes in CIV or CIV-shocks is not priced in the cross-section of stock returns in Indonesia. Investor may not consider any benefits in calculating firm level volatility as the factor that explain stock returns in Indonesia.

REFERENCES

- Ang, A., Hodrick, R. J., Xing, Y., & Zhang, X. (2006). "The Cross Section of Volatility and Expected Return". *The Journal of Finance*, 61(1), pp. 259-299
- Ang, A., Hodrick, R. J., Xing, Y., & Zhang, X. (2006). "High Idiosyncratic Volatility and Low Returns: International and Further US Evidence". *Journal of Financial Economics*, 91(1), pp. 1-23
- Bali, T. G., Cakici, N., Yan, X., & Zhang, Z. (2005). "Does Idiosyncratic Risk Really Matter?". *The Journal of Finance*, 60(2), pp. 905-929



- Bali, T. G. & Cakici, N. (2008). "Idiosyncratic Volatility and the Cross-Section of Expected Returns". *Journal of Financial Quantitative Analysis*, 43(1), pp. 29-58
- Bradrania, M. R., Peat, P., & Satchell, S. (2015). "Liquidity costs, idiosyncratic volatility and expected stock returns". *International Review of Financial Analysis*, 42, pp. 394-406
- Brooks, C. (2014). *Introductory Econometrics for Finance*. Cambridge University Press: United Kingdom.
- Campbell, J. Y., Lettau, M., Malkiel, B. G., & Xu, Y. (2001). "Have individual stocks become more volatile? An empirical exploration of idiosyncratic risk". *The Journal of Finance*, 56 (1), pp. 1-43
- Fu, F. (2009). "Idiosyncratic risk and the cross-section of expected return". *Journal of Financial Economics*, 91, pp. 24-37
- Goyal, A. & Santa-Clara, P. (2003). "Idiosyncratic Risk Matters!". *The Journal of Finance*, 57 (3).
- Guo, H. & Savickas, R. (2006). "Idiosyncratic volatility, stock market volatility, and expected stock returns". *Journal of Business & Economic Statistics*, 24 (1), pp. 43-56
- Herskovic, B., Kelly, B., Lustig, H., & Van Nieuwerburgh, S. (2016). "The common factor in idiosyncratic volatility: Quantitative asset pricing implications". *Journal of Financial Economics*, 119, pp. 249-283
- Huang, W., Liu, Q., Rhee, S. G. & Zhang, L. (2010). "Return reversals, idiosyncratic risk, and expected returns". *The Review of Financial Studies*, 23 (1), pp. 147-168
- Malkiel, B. G. & Xu, Y. (2002). "Idiosyncratic risk and security returns". *Working Paper*. Dallas: University of Texas.
- Miffre, J., Brooks, C., & Li, X. (2013). "Idiosyncratic volatility and the pricing of poorly diversified portfolios". *International Review of Financial Analysis*, 20, pp. 78-85
- Murhadi, W. R. (2013). "Pengaruh Idiosyncratic Risk dan Likuiditas Saham Terhadap Return Saham". *Jurnal Manajemen dan Kewirausahaan*, 15 (1), pp. 33-40
- Nartea, G. V., Ward, B. D. & Yao, L. J. (2011). "Idiosyncratic volatility and cross-sectional stock returns in Southeast Asian stock markets". *Accounting and Finance*, 51, pp. 1031-1054



- Nartea, G. V., Wu, J., & Liu, Z. (2013). "Does Idiosyncratic volatility matter in emerging markets? Evidence from China". *Journal of International Financial Markets, Institution, and Money*, 27, pp. 137-160
- Xu, Y. & Malkiel, B. G. (2003). "Investigating the Behavior of Idiosyncratic Volatility". *The Journal of Business*, 76 (4), pp. 613-645
- Yunengsih, A. and Husodo, Z. A. 2014. Analisis Volatilitas Idiosyncratic dan Imbal Hasil pada Pasar Modal Indonesia Periode 1993-2013. *Naskah ringkas*. Universitas Indonesia.



**COMPARISON OF USER EXPERIENCE ON GO-JEK AND GRAB MOBILE APPS
(A STUDY ON PT. GO-JEK AND PT. GRAB INDONESIA CONSUMERS IN DKI
JAKARTA)**

Maul Lydia Maharani

Arianis Chan

Pratami Wulan Tresna

Business Administration, Padjadjaran University

maudymhrn@gmail.com

arianis.chan@unpad.ac.id

pratami@unpad.ac.id

Abstract

This research examines the comparison of user experience between two mobile apps: Go-Jek and Grab by conducting a survey to look for differences in the experience perceived by one group of users of both applications. User experience is measured through the variable of sub-happiness, task success, earnings and uptime. The method used in this research is descriptive comparative analysis with quantitative approach. The sampling technique is done by accidental sampling based on spontaneous factors that involve the samples being drawn from the part of population that is close to hand. The number of samples is determined by using iterations at the amount of 63 respondents. The research object is user experience. The analysis of the data in this research uses paired t-test.

The result of this research shows that the t-value obtained, 2.420, is greater than t-table with $df = 67$ by 1.996, H_0 is rejected. So it is found that these mobile apps (Go-Jek and Grab) have differences regarding their User Experience.

Based on the results, the writers suggest Go-Jek to do more maintenance of the application to reduce the errors that still exist for the use in rush hour. The writers also suggest Grab Indonesia to add features to improve application's reliability.

Keywords: User Experience, mobile apps, Go-Jek, Grab.

JEL Classification: D12



INTRODUCTION

In an economic life of a country, information technology takes an important role because information technology advancement will improve the ability of productivity in the world of industry particularly in the field of information technology-based creative industry (Suciseptia, 2014). It can be seen from the emergence of various mobile applications in Indonesia both national and international products in which every year, the growth is significant. One of the software on internet utilized in marketing communication activities and brand establishment is an app. Nowadays, some companies at least have applications for their brands and products, both company and e-commerce apps.

According to Fenech and O’Cass (2001), “a representation of brand can influence consumer perception toward the brand so that marketers have to ensure the elements that exist on the site/app software can be a positive representation both in aesthetics and in providing what is perceived by the consumers.” A good representation can be created by forming a good experience. As what Schmitt (2008: 113) said, the only valid aim at marketing is the creation of valuable customer experience. It also applies in the world of internet. The experience perceived by users in engaging certain technology, including internet and sites, is known as user experience (Garrett, 2011: 6).

A rapid internet technology development causes change in public society. Many business start to appear by engaging the internet technology development. One of them is the business in service provider-based app in the field of online-based transportation mode that apparently can give solutions and answer various public worries about public transportation service. Traffic jam in big cities and public suspense with public transportation safety are solved with the existence of online transportation apps that provide ease and convenience for their users.

Numerous companies that offer similarly various service make the competition tighter. Online transportation business that recently have been known very well are Grab and Go-Jek. Both app-based transportation companies are proved causing a significant change mainly for public society lives. Even, these companies have become app-based service companies as public main choice especially in big cities. They compete each other tightly (Wiratri, 2016).



The level of rivalry of Go-Jek and Grab is getting higher. Those two companies have grown rapidly both in term of the number of rides for transportation service and app development on each company. Currently, Go-Jek app has been downloaded nearly ten million times both at Google Play Store and App Store (iOS). As a tough competitor of Go-Jek in this business, Grab app has been downloaded almost ten million times through Android smartphone. This app can also be downloaded on Apple and Blackberry (webhouzz.com, retrieved on January 2017).

These companies are innovating by developing offered features beside transportation service to fulfill the need of life style and logistics in one app. Go-Jek adds other services beside *ojek* transportation service, namely *Go-Car*, *Go-Food*, *Go-Mart*, *Go-Send*, *Go-Box*, *Go-Pulsa*, *Go-Massage*, *Go-Clean*, *Go-Glam*, *Go-Tix*, *Go-Auto*, *Go-Med*, and *Go-Busway* (Go-Jek.com, retrieved on December 20th 2016). Meanwhile, Grab provides *ojek* transportation service named *GrabBike*. Grab is also innovating by adding *GrabTaxi*, *GrabCar*, *GrabExpress*, *GrabFood*, *GrabHitch*, and its latest feature namely *GrabChat* to ease communicating between customers and driver partners (Grab.com, retrieved on December 20th 2016).

In this competition condition, the companies keep making effort to raise customer loyalty. Therefore, there needs to be a strategy as differentiation for each company in attracting customer interest and maintaining customers in order to keep using the company's service in the future.

Based on the background, the writers are interested to conduct a research entitled: **Comparison of User Experience on Go-Jek and Grab Mobile Apps (A Study on PT. Go-Jek and PT. Grab Indonesia Consumers in DKI Jakarta).**

LITERATURE REVIEW

User Experience

User experience has become the key aspect in product and service designs. According to Hassenzahl & Tractinsky (2006), an information system should not only be used and useful, but also make users convenient when engaging the system. Many experts say that user



experience offered is a success indicator of a site. Evaluating through UX approach functions to know what is perceived by users, whether users are happy or not, to gain ease, to get suppression feeling or satisfaction while using an app system.

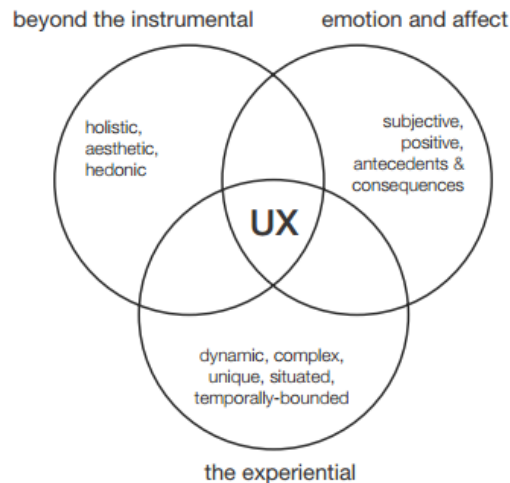

Figure 1. Three aspects on UX

Source: Hassenzahl & Tractinsky, pg. 95 (2006)

Definition of ‘experience’ according to Aaker (2000) is:

“The experience perceived by consumers through participation and involvement on internet has a stronger possibility than the experience perceived by consumers from other conventional media, so that it can be said that the quality of user experience on a site can affect the whole feeling, trust, and user assessment associated to a brand and it is strongly remembered compared to experience through other media.”

Online marketers can influence the process of virtual consumer design by delivering a good online experience; web experience; that is functional combination, information, feeling, clue, stimulus, and product or online service. In other words, running complex mixed marketing is more than traditional mixed marketing. User experience while online occurs with companies in cyberspace as the result of exposure to a combination to idea, feeling, and impulse due to the other marketing design and elements on online presentation (Constantinides, 2004).

According to Rodden, Hutchinson, and Xin Fu (2010), user experience

"...is regarded as a comprehensive concept describing the subjective experience resulting from the interaction with technology. Although the concept of UX is still rather young, there are a few common key assumptions that are widely accepted: UX is generally agreed to depend on the person (i.e. subjective) and contextual factors like physical, social and cultural aspects in the situation of use, and to be dynamic and temporally evolving over the instances of use."

In this research, the data collection uses HEART and PULSE framework to gain information about users. HEART is a framework that identifies the quality of UX. HEART framework is used to measure from the side of users, how users' feeling when using a mobile app. PULSE is a framework used for measurement in a big scale and focuses on business or technical aspects of a product (Rodden, Hutchinson, and Xin Fu, 2010). Both frameworks are chosen because they have measurement components that can measure all aspects related to user experience when using a mobile app and they can be used to measure UX that needs deep material questions.

The user experience measurement in this research refers to the research of HEART and PULSE factors elaborated according to Rodden, Hutchinson, and Xin Fu (2010) by using four instruments in which having indicators as follow:

1. *happiness*: satisfaction, visual attraction, possibility of recommendation, and perception of customer convenience;
2. *task success*: efficiency (for instance time to finish tasks), effectiveness (for instance percentage of finished tasks), and level of mistake occurred;
3. *earning*: perception of users toward benefits and advantages earned in accessing app; and
4. *uptime*: perception of users toward guarantee of information availability and feature reliability.

In this context, design or user experience can be concluded as a form of interaction between human and computer that covers mobile apps. The user experience is related to what is perceived by users in relation to ease, convenience, efficiency, and benefit while using mobile apps. A user experience designer can answer questions like: why a button is placed underneath an image, it has green color, it has a square with an arrow downward icon, as a UX designer effort to adjust the ability and experience the users. The conclusion is that UX is not what users see. UX designers do not only produce attractive designs to be seen, but also



answer why the design is produced like that, a design that is able to make users feel convenient when it succeeds obtaining its objectives when using a product.

Based on the information above, there will be a test to examine the phenomenon. Systematically, the writers depict a comparison of two research objects; they are the experience perceived by users on Go-Jek and Grab mobile apps and the instruments attached to the variables based on the theory used by the writers as follow:

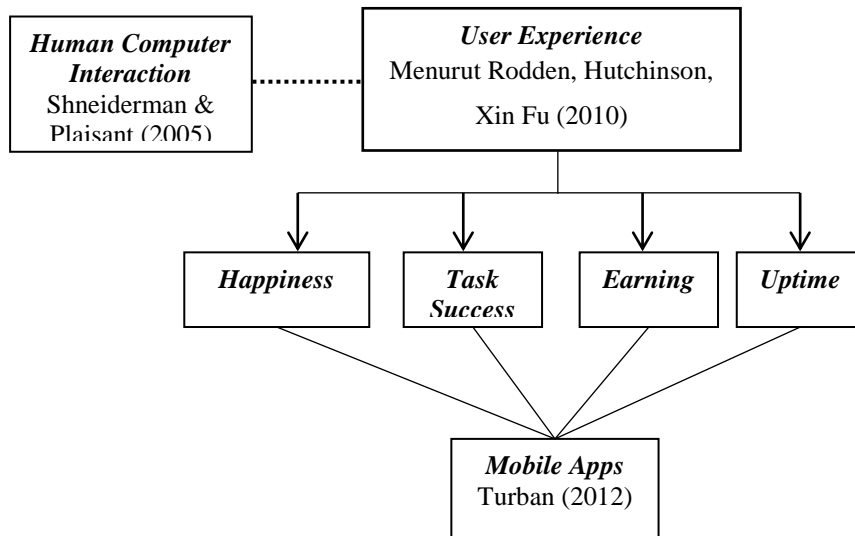

Figure 2. Framework Chart

explanation:

————— : observed

..... : not observed

Source: organized by the writers, 2017

HYPOTHESIS

Based on the framework above, the hypothesis of this research are:

1. there is difference of Happiness on Go-Jek and Grab mobile apps for users in DKI Jakarta;
2. there is difference of Task success on Go-Jek and Grab mobile apps for users in DKI Jakarta;
3. there is difference of Earning on Go-Jek and Grab mobile apps for users in DKI Jakarta;

4. there is difference of Uptime on Go-Jek and Grab mobile apps for users in DKI Jakarta; and
5. there is difference of ser experience on Go-Jek and Grab mobile apps for users in DKI Jakarta.

RESEARCH METHOD

This research is conducted on two apps (Go-Jek and Grab) with their own different characteristics. The reason of choosing these companies is because the companies have a similar position, especially in the number of app users within the top position particularly in DKI Jakarta. Therefore, by comparing them, the writers will identify the difference in term of experience perceived by users from both apps.

Research design used by the writers in this research is survey method because the writers take sample from one of population and collect the data using questionnaire. According to Ridwan (2011: 49), a survey research is usually conducted to gain a generalization from deep observation but the generalization can be more accurate if the research uses a representative sample.

Survey method is a method conducted on both big and small population by using questions or statements toward the issue related to the topic being studied. The type of method used in this research is descriptive comparative with quantitative approach. According to Sugiyono (2011: 147), a descriptive method is:

“Descriptive statistics is a statistics used to analyze data by describing or depicting collected data as it is, without intending to make a conclusion that applies to generalization.”

The comparative method in this research is directed to discover whether there are differences in the aspects or variables observed within the groups of Go-Jek and Grab mobile apps users or not. To do this research, the population taken by the writer is all customers of Go-Jek and Grab mobile apps in DKI Jakarta.

The amount of sample of this research will be decided using iteration technique. It is chosen due to the number of population of Go-Jek and Grab mobile apps users is uncertain. So, it is necessary to calculate a minimum number of sample to gain the number of respondent to be observed. The minimum samples that have to be taken are sixty three



respondents of both mobile apps users. There are characteristics of respondent in this research. They:

1. are located in Jakarta, Indonesia; and
2. have used both Go-Jek and Grab mobile apps at least two times.

Data analysis in this research engages SPSS software that aims to discover comparison between Go-Jek and Grab mobile apps user experience. The writers do a validation and reliability test first to the questionnaire so that this research can be accepted academically and be accountable.

To discover user experience comparison between Go-Jek and Grab mobile apps, the writers engage the approach of statistic descriptive analysis then they do classic assumption test.

Hypothesis Test

The hypothesis proposed in this research is user experience comparison test on Go-Jek and Grab mobile apps. In testing the hypothesis, the writers use paired t-test.

RESULTS AND DISCUSSION

Comparison of User Experience Assessment



Figure 3. Chart of Comparison Mean of User Experience Variable between Go-Jek and Grab Mobile Apps

Source: Data Processing 2017

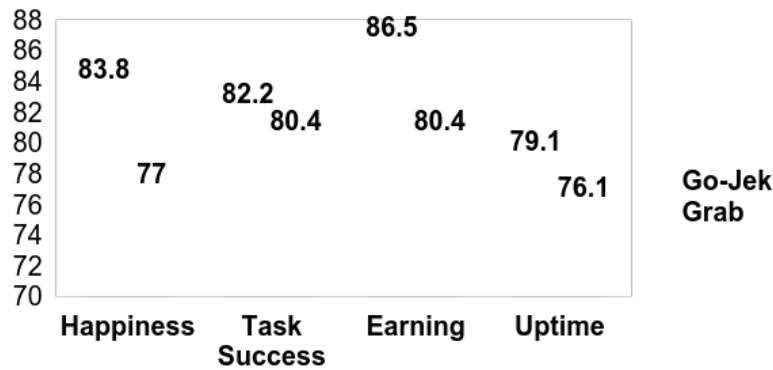

Figure 4. Chart of Comparison Mean of User Experience Sub-variable between Go-Jek and Grab Mobile Apps

Source: Data Processing 2017

On Figure 3, it can be seen that the mean of respondent on Go-Jek mobile app is 82.1. Meanwhile, the mean of respondent of Grab is 77.7 which is lower than Go-Jek. These values show that respondents see Go-Jek mobile app more positive than the assessment on user experience variable on Grab mobile app.

On Figure 4, it can be seen that the four sub-variables of user experience on Go-Jek mobile app are rated more than on Grab mobile app. It shows that the sub-variables that form user experience on Go-Jek mobile app are rated more positive than Grab mobile app.

Classic Assumption Test

Before going further to comparative analysis, the writers do classic assumption test as appropriateness in comparative analysis. The assumption test that will be done is normality test.

Normality test aims to see whether the sample data come from population data distributed normal or not. Normality assumption testing in this research uses histogram charts as follow:

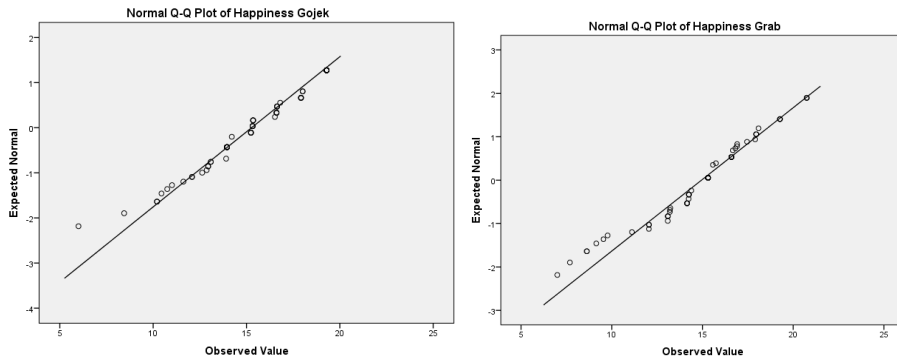

Figure 5. Normality Test of Happiness Sub-variable on Go-Jek and Grab

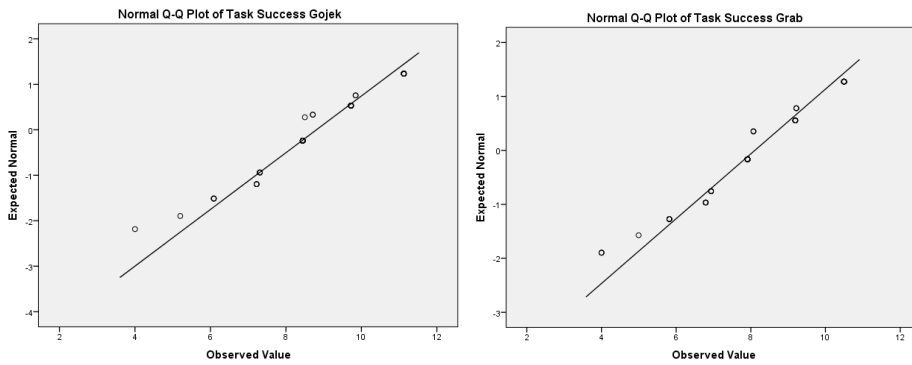

Figure 6. Normality Test of Task Success Sub-variable on Go-Jek and Grab

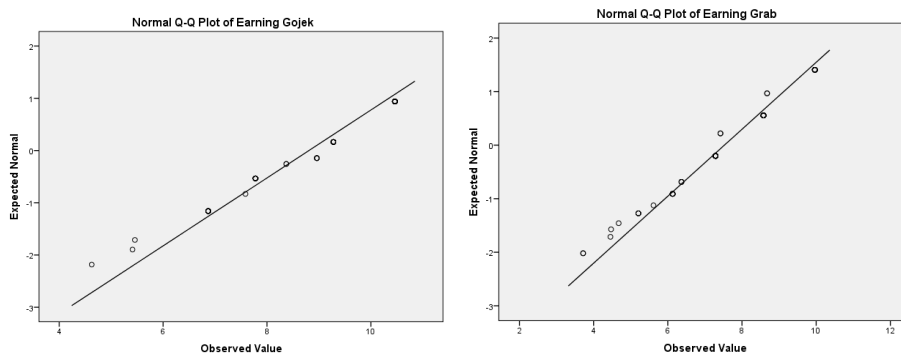

Figure 7. Normality Test of Earning Sub-variable on Go-Jek and Grab

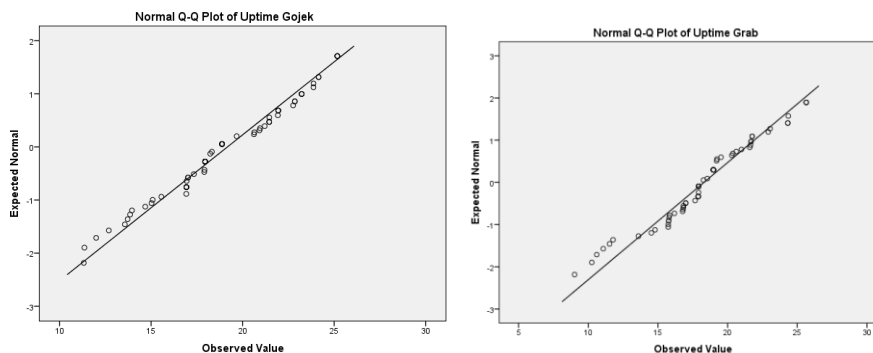

Figure 8. Normality Test of Uptime Sub-variable on Go-Jek and Grab

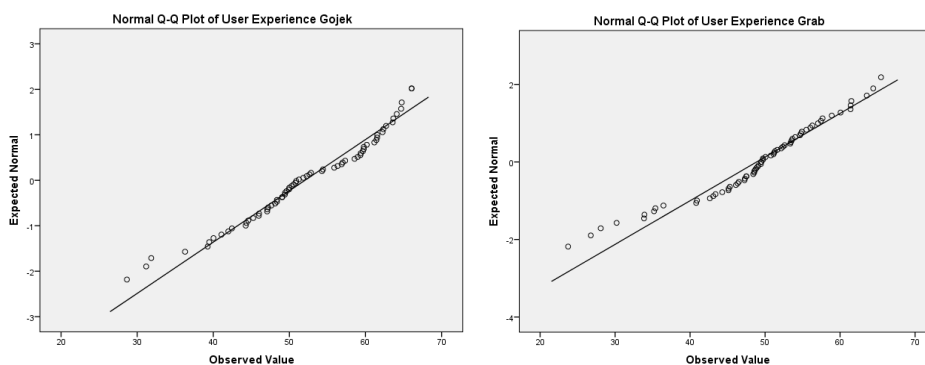

Figure 9. Normality Test of User Experience Variable on Go-Jek and Grab

Based on the results above, each result of normality assumption test shows that the data spreads around diagonal lines and follows the direction of diagonal lines or the histogram charts. So, it can be concluded that the whole data group has normal distribution then difference in hypothesis test with paired t-test can be done in this research.

Hypothesis Tests

A. The decision made regarding difference in sub-variable Happiness on Go-Jek and Grab, as follow:

$H_0 : \mu_1 = 0$ \rightarrow There is no difference in Happiness on Go-Jek and Grab mobile apps.

$H_1 : \mu_1 \neq 0$ \rightarrow There is difference in Happiness on Go-Jek and Grab mobile apps.

The basis of decision are:

- a. If $-t_{-\alpha/2} < t_{\text{count}} < t_{\alpha/2}$, H_0 is accepted.
- b. If $-t_{-\alpha/2} > -t_{\text{count}}$ or $t_{-\alpha/2} < t_{\text{count}}$, H_0 is rejected.

Table 1. Paired t-Test Result in Happiness

		Paired Differences					t	df	Sig. (2-tailed)
		Mean	Std. Deviation	Std. Error Mean	95% Confidence Interval of the Difference				
					Lower	Upper			
Pair 1	Happiness Gojek - Happiness Grab	.32693	4.07888	.49464	-.66037	1.31422	.661	67	.511

Based on Table 1, it can be seen that the value of t_{count} gained is 0.661 smaller than t_{table} value, with $df = 67$ at the amount of 1.996 then H_0 is accepted. So, it can be concluded that there is no difference regarding Happiness in Go-Jek and Grab users.

- B. The decision made regarding difference in sub-variable Task Success on Go-Jek and Grab, as follow:

$H_0 : \mu_1 = 0$ → There is no difference in Task Success on Go-Jek and Grab mobile apps.

$H_1 : \mu_1 \neq 0$ → There is difference in Task Success on Go-Jek and Grab mobile apps.

The basis of decision are:

- a. If $-t_{-\alpha/2} < t_{\text{count}} < t_{\alpha/2}$, H_0 is accepted.
- b. If $-t_{-\alpha/2} > -t_{\text{count}}$ or $t_{-\alpha/2} < t_{\text{count}}$, H_0 is rejected.

Table 2. Paired t-Test Result in Task Success

		Paired Differences					t	df	Sig. (2-tailed)
		Mean	Std. Deviation	Std. Error Mean	95% Confidence Interval of the Difference				
					Lower	Upper			
Pair 1	Task Success Gojek - Task Success Grab	.69909	1.86540	.22621	.24756	1.15061	3.090	67	.003

Based on Table 2, it can be seen that the value of t_{count} gained is 3.090 bigger than t_{table} value, with $df = 67$ at the amount of 1.996 then H_0 is rejected. So, it can be



concluded that there is difference regarding Task Success in Go-Jek and Grab users. Based on the result of mean test of paired sample statistics, it can be seen that mean value for Task Success in Go-Jek users is bigger than Task Success in Grab users. It means Task Success of Go-Jek is better than Grab.

C. The decision made regarding difference in sub-variable Earning on Go-Jek and Grab, as follow:

$H_0 : \mu_1 = 0$ → There is no difference in Earning on Go-Jek and Grab mobile apps.

$H_1 : \mu_1 \neq 0$ → There is difference in Earning on Go-Jek and Grab mobile apps.

The basis of decision are:

a. If $-t_{-\alpha/2} < t_{count} < t_{\alpha/2}$, H_0 is accepted.

b. If $-t_{-\alpha/2} > -t_{count}$ or $t_{\alpha/2} < t_{count}$, H_0 is rejected.

Table 3. Paired t-Test Result in Earning

		Paired Differences					t	df	Sig. (2-tailed)
		Mean	Std. Deviation	Std. Error Mean	95% Confidence Interval of the Difference				
					Lower	Upper			
Pair 1	Earning Gojek - Earning Grab	1.28188	1.90455	.23096	.82088	1.74288	5.550	67	.000

Based on Table 3, it can be seen that the value of t_{count} gained is 5.550 bigger than t_{table} value, with $df = 67$ at the amount of 1.996 then H_0 is rejected. So, it can be concluded that there is difference regarding Earning in Go-Jek and Grab users. Based on the result of mean test of paired sample statistics, it can be seen that mean value for Earning in Go-Jek users is bigger than Earning in Grab users. It means Earning of Go-Jek is better than Grab.

D. The decision made regarding difference in sub-variable Uptime on Go-Jek and Grab, as follow:

$H_0 : \mu_1 = 0$ → There is no difference in Uptime on Go-Jek and Grab mobile apps.



$H_1: \mu_1 \neq 0$ → There is difference in Uptime on Go-Jek and Grab mobile apps.

The basis of decision are:

- a. If $-t_{-\alpha/2} < t_{count} < t_{\alpha/2}$, H_0 is accepted.
- b. If $-t_{-\alpha/2} > -t_{count}$ or $t_{-\alpha/2} < t_{count}$, H_0 is rejected.

Table 4. Paired t-Test Result in Uptime

		Paired Differences					t	df	Sig. (2-tailed)
		Paired Differences		Std. Error Mean	95% Confidence Interval of the Difference				
		Mean	Std. Deviation		Lower	Upper			
Pair 1	Uptime Gojek - Uptime Grab	.86318	3.95578	.47971	-.09433	1.82068	1.799	67	.076

Based on Table 4, it can be seen that the value of t_{count} gained is 1.799 smaller than t_{table} value, with $df = 67$ at the amount of 1.996 then H_0 is accepted. So, it can be concluded that there is no difference regarding Uptime in Go-Jek and Grab users.

E. The decision made regarding difference in sub-variable User Experience on Go-Jek and Grab, as follow:

$H_0: \mu_1 = 0$ → There is no difference in User Experience on Go-Jek and Grab mobile apps.

$H_1: \mu_1 \neq 0$ → There is difference in User Experience on Go-Jek and Grab mobile apps.

The basis of decision are:

- a. If $-t_{-\alpha/2} < t_{count} < t_{\alpha/2}$, H_0 is accepted.
- b. If $-t_{-\alpha/2} > -t_{count}$ or $t_{-\alpha/2} < t_{count}$, H_0 is rejected.

Table 5. Paired t-Test Result in User Experience

		Paired Differences					t	df	Sig. (2-tailed)
		Mean	Std. Deviation	Std. Error Mean	95% Confidence Interval of the Difference				
					Lower	Upper			
Pair 1	User Experience Gojek - User Experience Grab	3.17107	10.80667	1.31050	.55530	5.78684	2.420	67	.018

Based on Table 5, it can be seen that the value of t_{count} gained is 2.420 bigger than t_{table} value, with $df = 67$ at the amount of 1.996 then H_0 is rejected. So, it can be concluded that there is difference regarding User Experience in Go-Jek and Grab users. Based on the result of mean test of paired sample statistics, it can be seen that mean value for User Experience in Go-Jek users is bigger than User Experience in Grab users. It means User Experience of Go-Jek is better than Grab.

The results are supported by the data from descriptive analysis result that state that from four sub-variables of user experience, namely Happiness, Task Success, Earning, and Uptime, positive mean is given to Go-Jek app as a platform that gives a good experience to its users. Go-Jek Company that apparently has established earlier in Indonesia especially in Jakarta can be the main factor of establishment level of Go-Jek as a platform that gives a positive experience to its users. Meanwhile, Grab that appeared after Go-Jek, even though it has been able to be a head-to-head competitor for Go-Jek in Jakarta, still has to admit the excellence of Go-Jek as the precursor that has produced user experience which does not only deal with user interface but also the aspect of user experience entirely including its business aspect that focuses on effort to fulfill the need and desire of users. So, the earlier emergence of Go-Jek compared to Grab makes it possible for Go-Jek to be able to understand the users' desire based on research activities, planning, development, and tests done around DKI Jakarta.

REFERENCES

- NN. (2008). *Mobile Applications*. Mmaglobal. p1.
- Aaker, David A. & Erich Joachimsthaler. (2000). *Brand Leadership*. London, Free



Press.

- Bernier, M. J., (1996). *Establishing the psychometric properties of A scale for evaluating Quality in Printed Educational Materials*. Patient Education and Counseling, 29, 283-299.
- Buttle, F. (2009). *Customer Relationship Management: Concepts and Technologies*, Butterworth-Heinemann.
- Constantinides, E. (2004). *Influencing the online consumers behaviour. The web experience*. Journal of Interest Research, 14(2), 111-126.
- Fenech, T., O’Cass, A., (2001). *Internet users’ adoption of web retailing: User and product Sub Variabelons*. Journal of Product & Brand Management, 10 (6), 361-381.
- Garrett, *et al.*, (2011), *The Elements of User Experience: User-Centered Design for the Web and Beyond (Second Ed)*, Berkeley: Pearson Education.
- Ghozali, Imam., (2012). *Aplikasi Analisis Multivariate dengan Program IBM SPSS 20*. Semarang : UNDIP.
- Hassenzahl, M., (2004). *The interplay of beauty, goodness, and usability in interactive products*. Human-Computer Interaction, 19,319-349.
- Kerry Rodden, Hilary Hutchinson, and Xin Fu., (2010). *Measuring the User Experience on a Large Scale: User-Centered Metrics for Web Applications*. 1600 Amphitheatre Parkway, Mountain View, CA 94043, USA.
- Marketeers Editor. Go-Jek Versus GrabBike, Siapa Menang?. *Marketeers Online*. (9 Juni 2015). <http://marketeers.com/go-jek-versus-grabbike-siapa-menang/>. Accessed on 5 October 2016.
- Nazir, M., (2003). *Metode Penelitian*. Jakarta:Ghalia Indonesia.
- Nielsen, J., (1993). *Usability engineering*. San Diego, CA: Academic Press.
- Nielsen-Norman Group. *User Experience*. (01 Mei 2007). Nielsen-Norman Group: <http://www.nngroup.com/about/userexperience.html>. Accessed on 28 September 2016.
- Norman, D. A., 2004. *Emotional Design: Why we love (or hate) everyday things*. New York: Basic Books.
- Octarendra. *Pilih Gojek Atau Grab Bike? Baca Gojek VS Grab Bike*. (2015, 06 07).



- Octarendra: <http://www.octarendra.com/pilih-gojek-atau-grab-bike-baca-gojek-vs-grab-bike/>. Accessed on 7 October 2016.
- Riduwan., 2004. *Belajar Mudah Penelitian*. Bandung: CV Alfabeta.
- Schmitt, B. H., 2008. *A Framework for Managing Customer Experience*, in B. H. Schmitt, D. L. Rogers, *Handbook on Brand and Experience Management* Cheltenham, UK: Edward Elgar Publishing Limited. pp. 113-131.
- Smith, Nicola., 2016. *Using virtual reality to enhance user experience*, Marketing Week (Online Edition);8/12/2015, p1.
- Sudjana., 2005. *Metode Statistika*. Bandung: Tarsito.
- Sugiyono., 2006. *Statistika Untuk Penelitian*, Alfabeta, Bandung.
- Sugiyono., 2011. *Metode Penelitian Kuantitatif Kualitatif dan R&D*. Bandung: CV Alfabeta.
- Turban, E., 2012. *Electronic Commerce*. Pearson 7th-Global Edition.
- <https://www.go-jek.com/>. (Accessed on 5 October 2016).
- <https://www.smashingmagazine.com/2010/10/what-is-user-experience-design-overview-tools-and-resources/>. Accessed on 5 October 2016.
- <http://uxdesign.com/ux-defined>. Accessed on 28 September 2016.
- <http://uxindo.com/training-ux-indonesia/ux-indonesia-training-jakarta/customer-journey-mapping/>. Accessed on 12 October.



“WHAT’S WRONG WITH A PHENOMENON UNDERPRICING?”

Astrid Maharani

University of Muhammadiyah Jember

astridmaharani89@yahoo.com

Abstract

The aims of this paper is to describe and explore the phenomenon of underpricing. Underpricing is the phenomenon of the low bid price and generally occurs during the initial public offering (IPO) and the seasoned equity offering (SEO) which the issuer using the underpricing as a "strategy". The phenomenon of underpricing caused due to asymmetry information between informed and uninformed investors which ultimately makes underpricing into a business strategy. Empirical studies indicates that the influence factors of the phenomenon of underpricing are underwriter reputation, auditor reputation, firm age, company size, larger board, board independence, the profitability of the company, and financial statements.

Keywords: *underpricing phenomenon, IPO, SEO*

JEL Classification: *G02*

INTRODUCTION

Underpricing phenomenon is a phenomenon that exists in the world of capital markets. Underpricing phenomenon often discussed in various capital markets research (Darmadi and Gunawan, 2013; Flagg and Margetis, 2008; and Anggarwal et al., 2002) that contribute to the development of research on the phenomenon of underpricing. Underpricing phenomenon usually occurs in the capital markets, especially in the primary market. Jogyanto (2014), explained about the type of capital markets in Indonesia :

1. Primary Market

A fresh securities by the company are sold in this market, and for securities newly sold can be either an initial public offering to the public (Initial Public Offering or



IPO) or additional securities new one if the company has been going public (Seasoned New Issue or Seasoned Equity Offering).

2. Secondary Market

Market that trades securities has been in circulation traded in this market.

3. Third Market

Market that run by brokers who bring together buyers and sellers when secondary market was closed.

4. Fourth Market

Capital markets that committed between institutions large capacity to avoid paying a commission to the broker which use communications networks to trade the stock in a large number of blocks.

Some experts define underpricing (Jogiyanto, 2014; Hopkins and Ross, 2014; Ljungqvist and Wilhelm, 2003; Aggarwal and Rivoli, 1990). Jogiyanto (2014) defines the phenomenon of underpricing is an interesting phenomenon that occurs in the initial offering to the public. Hopkins and Ross (2014) defines underpricing in the IPO is the practice of setting the initial offering price below what the market expected related to the value of shares following the issue. Ljungqvist and Wilhelm (2003) argue that underpricing phenomenon may occur due to problems between the principal and the agent. Aggarwal and Rivoli (1990) defines that underpricing is a phenomenon of over-valuation of the IPO or a trend. Based on some of these definitions it can be concluded that the underpricing phenomenon is a phenomenon of the low offer price which generally occurs at the time of the initial offering to the public and when the additional offers.

When discussing about the underpricing phenomenon could not be separated from the discussion related to the IPO (Initial Public Offering) and SEO (Seasoned Equity Offering) as both are times when companies use "strategy" underpricing. Why are so many that the IPO? For companies it means the acquisition of funds quickly, while for the underwriters as the right time to enhance their reputation in the market, and moment IPO for an investors is always the main attraction (Nugraha, 2004).

Jogiyanto (2014) explains that the Initial Public Offering (IPO) is the company's offering for the first time. The decision for going public or remains a private company is a



decision that must be considered deeply because if the company decides to going public and throwing stock debut to the public (Initial Public Offering), the main issue that arises is the type of what stocks will be thrown, what price which should be set for a piece of the shares and when it is most appropriate (Jogiyanto, 2014). There are several advantages of going public is 1) the ease of raising capital in the future, 2) increase liquidity for shareholders, and 3) the market value of the company is known, but behind some advantages there are some disadvantages of going public is 1) the cost of the report increased, 2) the disclosure of truly information, and 3) the fear of being taken over (Jogiyanto, 2014).

The actors of IPO that causes underpricing phenomenon are the issuers, underwriters, and investors (De Lorenzo and Fabrizio, 2001) which allegedly occurred asymmetric distribution of information among actors IPO. Companies referred to here is the issuer, described in Law No. 8 of 1995 on capital markets that the definition of the issuer are parties to a public offering. The issuer is a designation for companies that issue shares or bonds (bond), and the buyers are public (Tandelilin, 2010). There are two treatments of issuers according Tandelilin (2010):

1. The issuer's shares sell shares through a public offering either IPO (Initial Public Offering, IPO) to public investors, the next stock offerings (Seasoned Equity Offering).
2. The issuer's bonds sell bonds through public offer both IPO and the next bond offerings.

The underwriter is who make the process of underwriting, underwriting is the process of purchasing securities by investment bankers who will be sold back to the public (Jogiyanto, 2014) while also described in Law No. 8 of 1995 on capital markets that the underwriter are parties who makes a contract with the issuer to conduct a public offering for the benefit. Investors or capitalist are the ones who invest the funds in securities (Tandelilin, 2010) and make investments to improve utilities in the form of financial well-being (Jogiyanto, 2014), further described in Law No. 25 of 2007 on capital investment is an individual or business entity that makes an investment that can be either a domestic investor and a foreign investor.



For public bidding process in preparation for the IPO (Initial Public Offering) in stocks and bonds (www.idx.co.id) can be classified into several stages:

1. Preparation Stage

This stage is beginning to prepare everything related to the public offering process. It was first performed by the Prospective Listed Company is doing a General Meeting of Shareholders for approval of the shareholders in the Public Offering of shares. After the approval, the appointment Prospective Listed Company doing Supporting Institutions and Professionals of the Capital Market, that is:

- a) Underwriter is the most involved in helping prospective companies listed in order to issue shares by preparing various documents, helping to make the prospectus and provide guarantees for the issuance of securities.
- b) Public Accountant (Independent Auditor) are the people in charge to conduct an audit or examination of the Listed Company's Financial Statements and the Prospective Listed Company.
- c) Independent assessors who is a party to make an assessment on assets Prospective Listed Company and determining the fair value of these assets.
- d) Legal Consultants is a party to give a legal opinion.
- e) The notary is a party to make the deeds of amendment, deed of agreements in order to the public offering and the meeting notes.
- f) The Bureau of Securities Administration, tasked to administer the stock ordering and administering shareholding.

2. Filing of Registration Statement Stage

In this stage, the Prospective Listed Company completes supporting documents to submit the Registration Statement to OJK until the OJK has stated that the Registration Statement becomes effective.

3. Public Offering Stage

This stage is the main stage for Prospective Listed Company offered its shares to the public (investors). Investors can buy shares through a selling agent who has been appointed. This public offering period of at least one working day and a



maximum of 5 working days. Keep in mind that all the desire of investors for shares Prospective Listed Company can be wholly satisfied in the event of excess demand (oversubscribe). For example, the shares offered to the public through the Primary Market for 100 million shares, while the demand for the purchase of shares from all investors of 150 million shares. In case investors do not get the shares were booked through the Primary Market, then the investor can buy the stock in secondary market is the market where the shares were listed and traded on the Stock Exchange.

4. Registration of Shares on the Stock Exchange

After the completion of the sale of shares in the Primary Market, then shares are listed and traded on the Indonesia Stock Exchange.

Several studies have found evidence that when the IPO underpricing phenomenon usually occurs such as in Indonesia (Jogiyanto, 2014; Nugraha,) and in some countries, namely in the UK (Levis, 1993) and in the US (Loughan et al., 1994).

The phenomenon of underpricing most phenomenal for in Indonesia is when the IPO of PT. Krakatau Steel Tbk in 2010 dropped in which Lukas Setia Atmaja (2011) described that is like the investor has the cash machine where prices IPO shares of PT. Krakatau Steel Tbk on the primary market is Rp 850 per share while the investors can sell on the first day of trading in the Indonesia Stock Exchange Rp 1.270 per share. What is thought by PT. Krakatau Steel Tbk? Indeed, there is always a possibility that the IPO price are reasonable but investors act less rationally so that scrambling to buy shares. Krakatau Steel Tbk is currently traded in the secondary market. Still, the allegations of various parties that the price of shares. Krakatau Steel Tbk accidentally set underpriced and most stocks has been blocked a number of major institutions, including the politicians, for the sake of personal interests and groups with the aim of selling these shares at a much higher price when trading debut on the stock exchange and the facts show that after IPO PT. Krakatau Steel Tbk of total shares outstanding 15.755 billion, foreign investors have 7%, domestic investors 13% and government 80%.

Not only in Indonesia, in early 2006 McDonald announced go public subsidiary, Chipotle Mexican Grill at the offering price of \$ 22 per share, while the first day of trading on the exchange, stock prices soared and closed at \$ 44 per share, many of Mr. Average and



enjoy greater profits, and vice versa if the shares "overprice" the IPO, Mr. Genius will let Mr. Average purchase all shares offered. Mr. Average "win" but lost money, one strategy to address the problem of Winner's Curse and interesting Mr. Average to keep buying IPO shares, so that underwriters must offer underpriced the IPO price (Atmaja, 2011).

Underpricing phenomenon is not only found at the time of IPO (Initial Public Offering), but also when SEO (Seasoned Equity Offering) (Chemmanur et al., 2009; Cook and Officer, 1996). Despite the fact, the phenomenon of underpricing in SEO is not as big as at the time of IPO (Kim and Shin, 2001). SEO (Seasoned Equity Offering or Seasoned New Issue) is a new additional securities if the company has been going public (Jogiyanto, 2014). Sulistyanto Explained (2008) that Seasoned Equity Offerings (SEO) is an additional stock offering conducted by public companies that need additional funds to finance operations and investment activities as well as finding funds to pay long-term debt maturing.

According Sulistyanto (2008) for a stock offering SEO can be done in two ways, namely:

1. Through the mechanism of a rights issue or sell the rights to the existing shareholders to buy additional shares with certain price and at a certain moment. This mechanism is usually done by a company that his ownership was is concentrated with the aim of separately protecting the interests of existing shareholders in order to maintain the same proportion as their ownership before this equity offerings (preemptive right). This mechanism is commonly used by companies in the capital markets of developing countries (emerging market) that his ownership was tends to be concentrated on the person, family, or group.
2. Through a second mechanism offerings, offerings third, and so on, or sell additional shares to any investor in a market that wants to buy it not only to existing shareholders. This mechanism is commonly used by companies in the capital markets of developed countries (developing market) that his ownership was tends to spread in many parties and there is no majority shareholder. However, in contrast to the rights issue, the share price in this mechanism is purely determined by the supply and demand in the market. The share price will be high if the market demand is high, otherwise the share price will be low if the



market demand is also low.

In Indonesia, all related to capital markets and investment has been regulated by the Law No. 8 of 1995 on the Capital Market and Law No. 25 of 2007 on Investment. Both of law is expected to be a reference or guidelines for market participants, particularly those associated with underpricing phenomenon in Indonesia. Because of this phenomenon does not only happen in Indonesia, but also in various parts of the world, then the question arises lay of this underpricing phenomenon: whether the phenomenon of underpricing can be tolerated or who the beneficiaries of this underpricing phenomenon? This research aims bridging the wide range of research related to the phenomenon of underpricing into a comprehensive unity and explore the phenomenon of underpricing.

HOW THE OCCURRENCE OF UNDERPRICING PHENOMENON?

Darmadi and Gunawan (2013) and Cook and Officer (1996) explain that phenomenon of underpricing is supported the signaling theory. Scott (2009) definition that: “A signal is an action taken by a high-type manager that would not be rational if that manager was low-type.” From these definition, it can be explained that the signal is an action taken by the manager high-type irrational if done by a low-type profile. This indicates that the transmission of signals conducted by the manager of the high-type where a manager of high-type seen by investors to have information that is more credible than the manager of the low-type, so that managers of high-type which will provide information to investors and is responsible for the provision of such signals. Then described further by Scott (2009) that the existence of a certain standard in a country about standardization in accounting would reduce the ability of high-type manager to transmit signals to the investor or prospective investor.

Research of Darmadi and Gunawan (2013) found that according to the signal theory described by Leland and Pyle (1977), because of the asymmetry of information between the issuer and investors, the company sends a signal about which aims to show the best quality companies and that the conflict of ownership between the principal and the agent can be minimized as well to show other signals companies IPO can communicate how the reputation of their external auditors.



Signal theory relating to the prospectus was information released about the company detailed which serves to provide information about the condition of the company to potential investors, so that the existence of such information, the investor will be able to know the company's prospects in the future, and further interested in buying securities issued from the issuer (Tandelilin, 2010).

Further explained about how public investors or the general public to buy stocks or bonds in the primary market, where before deciding on investments, investors can start by learning the prospectus described by Tandelilin (2010) contains among others:

1. Type of business and history of the issuer
2. Number of share or bond that offered to the public and a bid price
3. The purpose of IPO
4. The issuer's prospect and business risk in the future
5. Debt payments and dividend policy
6. The historical financial performance
7. The sales agent who participated in the process of IPO
8. The implementation schedule of IPO

Tandelilin (2010) explained that investor can get prospectus in stock company and read in newspaper, financial reporting was included in prospectus and as additional, the issuer must be publish financial reporting regularly. It's supported research of Friedlan (1993) that financial reporting information effected IPO's bid price.

Jogiyanto (2014) describe that phenomenon of underpricing happened since the first offer to the public that the average cost of which is buy the average stock in the IPO could get back the initial high, mean the intention is not all the initial offering cheap, but it can also be expensive and means that they can be said to be cheap (underpricing). Further described that the initial return is the return earned on the assets in the initial offering from when purchased in the primary market until the first registered in the secondary market.

Companies usually hand over problems related with the IPO (Initial Public Offering) of the company to an investment banker (investment banker) who have expertise in the sale of securities in which the sale of new shares involving an investment banker is on sale in the primary market (Jogiyanto, 2014). Then the investment banker who is the intermediary



between companies that sell shares (issuer) with the investor, who did his job to advise the company in preparation for the sale of securities to the public in the form of recommendations concerning: 1) the type of securities what will be sold, 2) how much the price of the securities, 3) when the time throwing securities and also functions as a giver of advice (advisory function), investment bankers also serves as a buyer of shares (underwriting function) and serves as a marketer shares to investors (marketing function) as described Jogyanto (2014).

Some of the technical stages of the preparation process of go public including: (Rahardjo, 2006):

- BAPEPAM will declare the effectively registration on 45 days after the issuer and the underwriter (lead underwriter hand over a complete administrative file to BAPEPAM.
- Issuers (companies that go public) are expected to provide a complete prospectus for potential investors, as well as the prospectus that was published in a national newspaper; conducted three working days before the public offering
- Prospective buyers of shares who are interested can start an order to the underwriter by its appointed sales agents.
- After the offering period, followed by allotment of securities or securities allocation of orders from investors according to the number of shares available.
- Allotment period of about six days after the expiration of the offering period. Securities that have been allocated to investors in the form submitted a collective share certificate.
- If some or all reservations investor there are rejected (for example because of the limitations of securities sold) or turns the event of cancellation deals, investors will receive a refund no later than four working days after the date of allotment.

Issuers will make the process of preparation go public must make professional cooperation with various stakeholders such as a capable's lead underwriter who search potential investors. Friedlan (1993) revealed that the share price at the time of the IPO before selling it to potential investors, the issuer and underwriters must use non-financial information about the pricing of the company's offerings and accounting (as basis of



measurement) is often identified as being very useful in assessing the securities so that update report financial affect the IPO offering price.

In outline, the underpricing is a signal given by the company to potential investors in order for them to invest their money in shares of IPO (Initial Public Offering) and SEO (Seasoned Equity Offering) in which information to be launched by financial information (financial statements) and information non-financial (prospectus) described that the determination of the current stock price when the IPO and SEO suggested by underwriters using low price (underpricing).

WHY UNDERPRICING PHENOMENON HAPPEN?

Many research that discussed the causes of the occurrence of underpricing be a topic that is still interesting area for research, considering that this phenomenon inevitable in part of the world countries. Described in the book *The Phenomenon of IPO Underpricing in the European and US Stock Markets* that there are four things that are considered to motivate the underpricing during the IPO that is asymmetry of information (information asymmetry), explanation of the institution (institutional explanations), a model of ownership and control (ownership and control models), an explanation of behavior (behavioral explanations).

Scott (2009), defines asymmetry of information is part of a business transaction where one side has more information than the advantages of others. According to Scott (2009), asymmetry of information is divided into two types, namely: 1) Adverse selection, is one type of information asymmetry if one side (the manager) has the benefit of information exceeds the other hand, many ways for managers and other insiders can exploit the benefit of their information on the cost of outside parties; 2) Moral hazard, arises because of the separation of ownership and control and moral hazard happened when one hand can observe the actions of other hand in the transaction.

In a research with entitled "Regulatory Strategies Under Asymmetric Information" performed by Baron (1982) explains that the information asymmetry happened between the issuer (company) and the underwriter caused by underwriters have more information than the issuer (company). The share price could drop in the first week on the secondary market if the IPO price was set too high. The underwriters will be facing angry's investor who buy stocks



overpriced. To "calming" the investor and image building, underwriters tends to propose a price "underpriced" (Atmaja, 2011). This is unexpectedly and indicates the asymmetry of information between underwriter with issuers.

In a study entitled "Why New Issue Are underpriced" by Rock (1986) explains that underpricing occurs because of the asymmetry information that exists in the IPO among investors who have information (informed investors) to investors who do not have the information (uninformed investors) who then this information asymmetry is called "Winner's Curse".

This was in line with research conducted by Hanley, et al. (1993) and Ruud (1993) that the phenomenon of underpricing happened because it is dominated asymmetry of information. Not only in the case when the IPO, underpricing phenomenon but also happened because of the asymmetry of information at the time of SEO, it is the result of research of Chemmanur and Jiao (2011). Thus outline can be concluded that an information asymmetry consists of two models, and it's called Baron's Model (1982), which revealed that the asymmetry of information occurred between the owner of the company (management) with underwriters and model of Rock (1986), which revealed that the information asymmetry happened among investors who have information and investors who do not have the information. Discusses the phenomenon of underpricing is not separated from the relation with the reputation underwriter, explained that the reputation underwriter and underpricing is positively correlated (Loughran and Ritter, 2004; Cooney, et al., 2001; Ruud, 1993) which proves that there is a role of underwriter to the phenomenon of underpricing, Flagg and Margetis (2008) also discusses whether the characteristics of underwriters influence the underpricing phenomenon.

Several things that became the reason of the occurrence of the phenomenon of underpricing, implying that most of company do an IPO and SEO improve "underpricing treatment" on their shares so that seems to be the company's strategy to encourage investors to invest in their IPO's stock and SEO's stock , and with the findings of Rock (1986) that "discount price" of these shares used to attract investors, consistent case this very suitable for investors who expect a capital gain and initial return. In addition underpricing occurs when SEO is also one of the company's business strategy (Chemmanur and Jiao, 2011) to be in line



with that presented at the IPO, underpricing phenomenon can be used as a strategy for companies to attract investors.

WHAT ARE THE FACTORS THAT INFLUENCING UNDERPRICING PHENOMENON?

Several previous research discusses the factors considered to influence the phenomenon of underpricing. Darmadi and Gunawan (2013) found the facts in the company's IPO in Indonesia who experienced the phenomenon of underpricing that independence board has a positive correlation to underpricing, but the phenomenon of underpricing has a negative correlation with board size and institutional ownership which indicates that they play a role in reducing information asymmetry that occurs between the issuer and potential investors in the IPO. Further explained that the company's profitability was found to positively affect the level of underpricing, which indicates that investors see the high level of performance as a signal of good quality of the company, as well as the auditor reputation and the reputation of underwriters are found to be significant and negative which supports the notion that the auditor and underwriter leading play an important role in reducing the asymmetry of information between issuers and potential investors. In addition, a senior official and Gunawan (2013) also explains that with the supervision of the government to the company led to the underpricing the higher tendency for case studies in Indonesia by using a sample of 101 companies in the primary market in the years 2003-2011.

Hearn (2011) conducted a study in West Africa find results that larger board positively related to the level of underpricing, which is reflected in the cost of information asymmetry arising from coordination and decision-making problems. Aggarwal, et al. (2002) wrote a journal titled Strategic IPO Underpricing, Information Momentum, and Lockup Expiration Selling that test IPO in 1994 and 1999 which have an extreme underpricing on the first day. The findings of this study are caused of underpricing magnitude as well shares managerial and ownership and selection of the first day underpricing to create a momentum.

Kim and Shin (2001) explains that there is underpricing at the time of SEO during the 1990s but did not find the phenomenon of underpricing during the 1980s in which SEO for this research using more than 3.000 Seasoned Equity Offering (SEOs) from 1983 to 1998.



Chemmanur et al. (2009) describes the relation of SEO and underpricing find evidence that there is an average of 3.5% underpricing on SEO in the period of 1999-2004.

Rahman and Yung (1999) examined the underpricing theory using data from the Wall Street Journal which is the Directory of Corporate Finance since January 1983 to December 1990. This paper discusses whether the underpricing in IPOs in regulated industries such as insurance in America. The research found significant evidence of the combined effect on price support and asymmetry of information about insurance IPO. This shows that there are regulatory problems, monitoring, and reporting on the insurance industry do not eliminate the underlying factors that lead to information asymmetry IPO underpricing. Also explained that underpricing is more significant when the issues covered by the non prestigious underwriters, it is in accordance with the literature or previous research.

Utaminingsih, et al. (2013) found that IPO trading based on asymmetric information between heterogeneous investors. Using data from various sources and databases from January 2001 to December 2010. The results Utaminingsih, et al. (2013) that in the process of underpricing an IPO, underwriters have an active role which underpricing is the main issues and underwriter managing IPO's trading by determining the range of the price offered and discriminatory treatment between institutional and individual investors. Furthermore, underwriters give priority to institutional investors, especially when they indicate a powerful interest to buy at the time of book building. This research proves that underpricing is higher when the price of the IPO is closer to the upper limit of the price range. It was also found that underpricing is higher when the allocation of shares to institutional investors greater.

Triani and Nikmah (2006) describes the impact of IPO practices in Indonesia that carried out to all the company's IPO on the JSE over the period 1994-2000 with a total sample of 90 companies and using OLS regression and chow test for hypothesis test. The results of this research shows that underwriter reputation positive significant effect on the initial return, the stock offering significant negative effect on the percentage of the company's performance one year after the IPO. Furthermore, the auditor's reputation shows no correlation with the initial returns. Friedlan (1993) in a journal entitled "Accounting Choices of Issuers of Initial Public Offerings" by using a sample of 277 companies IPO in the US during the years 1981-1984. Friedlan research results (1993) explains that earnings of the IPO



issuers increase discretionary accruals in financial statements released before the stock offering. The conclusion that the financial statement information affecting the bid price when the IPO.

From the various previous research, it can be concluded that the factors that influence the occurrence of the phenomenon of underpricing which is underwriter reputation (Ruud, 1993; Darmadi and Gunawan, 2013; Rahman and Yung, 1999; Utaminingsih, 2013), auditor reputation (Beatty, 1989; senior official and Gunawan, 2013), age of the firm (Beatty, 1989), the size of the company (Beatty, 1989), larger board (Hearn, 2011), board independence (Darmadi and Gunawan, 2013), the company's profitability (Darmadi and Gunawan, 2013), and financial statements (Friedlan, 1993).

CONCLUSION

Underpricing phenomenon is a phenomenon that exists in the world of capital markets. Underpricing phenomenon often discussed in various capital markets research that contribute to the development of research on the phenomenon of underpricing. The underpricing phenomenon is arises phenomenon when IPO (Initial Public Offering) and SEO (Seasoned Equity Offering). This is the time for companies to use "strategy" underpricing. The actors of IPO that causes underpricing phenomenon are the issuers, underwriters, and investors. The question arises lay of this underpricing phenomenon: whether the phenomenon of underpricing can be tolerated or who the beneficiaries of this underpricing phenomenon?

The underpricing is a signal given by the company to potential investors in order for them to invest their money in shares of IPO (Initial Public Offering) and SEO (Seasoned Equity Offering) in which information to be launched by financial information (financial statements) and information non-financial (prospectus) described that the determination of the current stock price when the IPO and SEO suggested by underwriters using low price (underpricing).

Several things that became the reason of the occurrence of the phenomenon of underpricing, implying that most of company do an IPO and SEO improve "underpricing treatment" on their shares so that seems to be the company's strategy to encourage investors to invest in their IPO's stock and SEO's stock , and with the findings of Rock (1986) that



"discount price" of these shares used to attract investors, consistent case this very suitable for investors who expect a capital gain and initial return. In addition underpricing occurs when SEO is also one of the company's business strategy (Chemmanur and Jiao, 2011) to be in line with that presented at the IPO, underpricing phenomenon can be used as a strategy for companies to attract investors

From the various previous research, it can be concluded that the factors that influence the occurrence of the phenomenon of underpricing which is underwriter reputation (Ruud, 1993; Darmadi and Gunawan, 2013; Rahman and Yung, 1999; Utaminingsih, 2013), auditor reputation (Beatty, 1989; senior official and Gunawan, 2013), age of the firm (Beatty, 1989), the size of the company (Beatty, 1989), larger board (Hearn, 2011), board independence (Darmadi and Gunawan, 2013), the company's profitability (Darmadi and Gunawan, 2013), and financial statements (Friedlan, 1993).

REFERENCES

- Aggarwal, Rajesh K., Laurie Krigman, and Kent L. Womack. (2002). "Strategic IPO Underpricing, Information Momentum, And Lockup Expiration Selling." *Journal of Financial Economics*: 105-137.
- Aggarwal, Reena, and Pietra Rivoli. (1990). "Fads In The Initial Public Offering Market?." *Financial Management*: 45-57.
- Atmaja, Lukas Setia. (2011). *Who Wants To Be An Irrational Investor: Portofolio Artikel Investasi Saham Di Harian Kontan*. Jakarta: Kepustakaan Populer Gramedia bekerja sama dengan Harian Kontan.
- Baron, David P. (1982). "A Model Of The Demand For Investment Banking Advising And Distribution Services For New Issues." *The Journal of Finance*: 955-976.
- Beatty, Randolph P. (1989). "Auditor Reputation And The Pricing Of Initial Public Offerings." *Accounting Review*: 693-709.
- Chemmanur, Thomas J., and Yawen Jiao. (2011). "Institutional Trading, Information Production, And The SEO Discount: A Model Of Seasoned Equity Offerings." *Journal of Economics & Management Strategy*: 299-338.



- Chemmanur, Thomas J., Shan He, and Gang Hu. (2009). "The Role Of Institutional Investors In Seasoned Equity Offerings." *Journal of Financial Economics*: 384-411.
- Cook, John P., and Dennis T. Officer. (1996). "Is Underpricing a Signal of Quality in 'Second' Initial Public Offerings?." *Quarterly Journal of Business and Economics*: 67-78.
- Cooney, John W., *et al.* (2001). "IPO Initial Returns And Underwriter Reputation: Has The Inverse Relationship Flipped In The 1990s?." *University of Kentucky, Case Western Reserve University, and Iowa State University Working Paper*.
- Darmadi, Salim, and Randy Gunawan. (2013). "Underpricing, Board Structure, And Ownership: An Empirical Examination Of Indonesian IPO Firms." *Managerial Finance*: 181-200.
- Eduardus, Tandelilin. (2010). *Portofolio dan Investasi (Teori dan Aplikasi)*. Yogyakarta: Penerbit Kanisius.
- Fabrizio, Stefano, and Massimo De Lorenzo. (2001). "Asymmetric Information And The Role Of The Underwriter, The Prospectus And The Analysts In Underpricing Of Ipos: The Italian Case."
- Flagg, Donald, and Speros Margetis. (2008). "What Characteristics of Underwriters Influence Underpricing?." *The Journal of Private Equity*: 49-59.
- Friedlan, John M. (1994). "Accounting Choices of Issuers of Initial Public Offerings". *Contemporary Accounting Research*: 1-31.
- Hanley, Kathleen Weiss. (1993). "The Underpricing Of Initial Public Offerings And The Partial Adjustment Phenomenon." *Journal Of Financial Economics*: 231-250.
- Hearn, Bruce. (2011). "The Impact Of Corporate Governance Measures On The Performance Of West African IPO firms." *Emerging Markets Review*: 130-151.
- Hopkins, Mike, and Donald G. Ross. (2014). "Is Underpricing an Appropriate Proxy for Studying IPO Certification?." *International Journal of Economics and Finance*: p117.
- Jogiyanto, Hartono. (2014). *Teori Portofolio dan Analisis Investasi: Edisi Kesembilan*. BPFE: Yogyakarta
- Kim, Kenneth, and Hyun-Han Shin. (2001). "The Underpricing Of Seasoned Equity Offerings: 1983-1998." *EFA 2001 Barcelona Meetings*.



Law No. 8 Of 1995 On Capital Markets

Law No. 25 Of 2007 On Capital Investment

Levis, Mario. (1993). "The Long-Run Performance Of Initial Public Offerings: The UK Experience 1980-1988." *Financial Management*: 28-41.

Ljungqvist, Alexander, and William J. Wilhelm. (2003). "IPO Pricing In The Dot- Com Bubble." *The Journal of Finance*: 723-752.

Loughran, Tim and Jay R. Ritter. (2004). "Why Has IPO Underpricing Changed Over Time?" *Financial Management*: 5-37.

Nugraha, Ubaidillah. (2004). *Secangkir Teh Hangat Pasar Modal*. Jakarta: Gramedia Pustaka Utama.

Raharjo, Sapto. (2006). *Kiat Membangun Aset Kekayaan*. Jakarta: Elex Media Komputindo.

Rahman, Hamid, and Kenneth Yung. (1999). "Insurance IPOs—A Test of the Underpricing Theories." *Journal of Insurance Issues*: 61-77.

Rock, Kevin. (1986). "Why New Issues Are Underpriced." *Journal of financial economics*: 187-212.

Ruud, Judith S. (1993). "Underwriter Price Support And The IPO Underpricing Puzzle." *Journal of Financial Economics*: 135-151.

Scott, William Robert. (2009). *Financial Accounting Theory*. Fifth Edition. Toronto: Pearson Prentice Hall.

Sulistiyanto, Sri. (2008). *Manajemen Laba: Teori dan Model Empiris*. Jakarta: Penerbit Grasindo.

Triani, Apriliani. Nikmah. (2006). Reputasi Penjamin Emisi, Reputasi Auditor, Persentase Penjamin Emisi, Ukuran Perusahaan dan Fenomena Underpricing: Studi Empiris pada Bursa Efek Jakarta. *Simposium Nasional Akuntansi IX Padang*.

Utamaningsih, Arni., Tandelilin, E., dan Suad Husnan. (2013). Asymmetric Information In The IPO Underwriting Process On The Indonesia Stock Exchange: Pricing, Initial Allocation, Underpricing, And Price Stabilization. *Journal of Indonesian Economy and Business Volume 28, Number 3, , 311 – 321*

www.idx.co.id/ accessed on 3 May 2015.



**MANAGEMENT OWNERSHIP AND STOCK PRICE INFORMATIVENESS IN
INDONESIA STOCK MARKET**

Indra Ambarita

Cynthia Utama

Graduate School of Management, Faculty of Economics and Business, University of
Indonesia, Depok, Indonesia
ig.ambarita@gmail.com

Abstract

This paper investigates the impact of management ownership i.e. director's and commissioner's shares, on the amount of firm-specific information incorporated into stock prices, as measured by stock price synchronicity of Indonesian-listed firms over the 2013-2015 period. Studies have shown that at least there are two effects of management ownership in prices i.e. convergence-of-interests effect and entrenchment effect. Also, previous research shows that stock price efficiency depends on the cost of acquiring private information. We hypothesize that these characteristics will manifest itself primarily in the firm-specific component of returns. Our empirical test finds that director's and commissioner's ownership in a company nonlinearly increase the probability of capitalization of firm's specific information to stock prices. Thereby, making firm's stock prices less synchronous to the market and the industry movements. Overall, our findings support the contention that ownership structure plays a significant role in shaping the firm's information environment.

Keywords: management ownership, stock price synchronicity, Indonesia

JEL Classification: G14

INTRODUCTION

Efficient market hypothesis indirectly states that information is the key to the dynamic of stock prices which in turn will determine stocks' return. Roll (1988) finds that a large proportion of stock return variation is not explained by changes in market wide variables or by publication of value-related public information. Further, he says that it is an indication of



the amount and rate of private information capitalization into stock prices via informed trading. This study attracts a growing body of finance literature that provides consistent evidence with information-based interpretation of stock price synchronicity or firm-specific return variation. For example, Morck, Yeung, and Yu (2000) examine worldwide synchronicity at the country level, and find that stock price movements are more synchronous in emerging markets with greater barriers to informed trading than in developed markets with lesser barrier. They argue that high synchronicity, commonly in emerging markets, is led by poor investor protection which discourages informed trading. Another follow up study, Jin and Myers (2006) show that synchronicity decreases with a country's accounting transparency. Latest studies by Fernandes and Ferreira (2008, 2009), Kim and Shi (2009), He et al. (2013), Hasan et al. (2014), and Lin et al. (2015) also argue synchronicity to be higher in emerging markets than in developed markets.

The purpose of this study is to investigate the effect of corporate governance mechanism to synchronous movement of stock prices in the equity market of Indonesia. Corporate governance has been a hot topic since the financial crisis that delivered shock to the global economy (OECD, 2015). Earlier in Indonesia, weak corporate governance is seen as the main cause of economic crisis in 1998 (OECD, 2012). Corporate governance is aimed at enforcing rights and obligations of all stakeholders as proclaimed in the basic principles of corporate governance i.e. fairness, transparency, accountability, and responsibility. Hence, the discussion about the influence of corporate governance in the capital market is very attractive to be explored.

This study is motivated by Ashbaugh et al. (2004) and Setyaningrum (2005) who investigated the effect of corporate governance, via multiple proxies, to corporate bond rating. Different with those studies, this study examines the influence of corporate governance to incorporation of company specific information into stock prices which is proxied by the stock price synchronicity. Moreover, this study use management ownership as the proxy of corporate governance as the interest variable as studies have not yet covered the topic.

Researches about stock price synchronicity already cover multiple factor for example study to examine the association between stock price synchronicity and efficient capital



allocation (Pindyck and Rotemberg, 1993; Wurgler, 2000), analyst activity (Piotroski and Roulstone, 2004; Chen and Hameed, 2006), earnings informativeness (Durnev et al, 2003), corporate transparency (Jin and Myers, 2006), voluntary disclosure (Haggard et al., 2008), earnings management (Hutton et al., 2009), audit quality (Gul et al., 2010), adoption of IFRS (Kim and Shi, 2012), and ownership structure (Boubaker et al., 2014).

We study the link between synchronicity and corporate governance characteristics in Indonesia that are deemed to influence the flow of firm-specific information to equity market. This linkage emerges through the effects of corporate governance on management or managerial constraints and incentives, which are likely to influence the information environment and stock prices. Based on study by Ashbaugh et al. (2004) and Setyaningrum (2005), ownership in Indonesia scope at least still has some area underexplored in relation to stock price synchronicity. Both studies pin points that management ownership i.e. holding in by commissioners or directors in the company, has channel to influence company management incentives or managerial constraints as proxied against company bond rating. This study aims to close the gap by exploring relevancy to the topic of stock prices movement.

Previous researches document that ownership structure affects the informational environment of a firm and its decision making. For instance, Ball et al. (2003) argue that, beyond accounting standards, the distribution of cash flow and voting rights shape the outcome of financial reporting procedures. Other studies also show that ownership structure turns out to explain earnings management (Warfield et al., 1995), earnings informativeness (Fan and Wong, 2002), analyst following (Lang et al., 2004; Boubaker and Labégorre, 2008), accounting conservatism (Lafond and Roychowdhury, 2008), and the cost of corporate borrowing (Boubakri and Ghouma, 2010; Lin et al., 2011), among others. This paper brings together strands of literature by addressing the important but hitherto underexplored question of whether ownership structure matters in explaining the synchronicity of stock price movements. The linkage is based on the classical idea that ownership structure affects managerial incentives and therefore exacerbates or mitigates agency problems between shareholders and professional managers (Jensen and Meckling, 1976).



Morck and Vishny (1987) infer that there are two hypotheses when managers hold equity in the firm and shareholder are too dispersed to enforce value maximization. First, entrenchment hypothesis that is corporate assets may be deployed to benefit management rather than shareholders. Such managerial benefits can include shirking and perquisite-taking, but also encompass pursuit of such non-value-maximizing objectives as sales growth, empire building, and employee welfare. Second, convergence-of-interest hypotheses that is market value of company increases with management ownership. Further, as managements holding increases, managements pay a larger share of cost from value-maximization deviation and are less likely to squander corporate wealth. In relation to voluntary disclosure of company information to public, the entrenchment hypotheses have negative impact while convergence-of-interest have the opposite. Disclosure have very important role in dynamics of stock return (Haggard et al., 2008). Hence, management ownership cannot be just ignored in the discussion of stock price synchronicity. Theoretical arguments alone cannot unambiguously predict the relationship between management ownership and incorporation of information disclosed by company to stock price. This study determines to provide empirical hypotheses testing.

This study contributes to the extant literature in several ways. First, we provide a unique focus on firm-level governance characteristics in a fast growing and arguably one of the biggest emerging market—Indonesia. Our results help us better understand the effects of firm-level investor protection mechanism on firm-specific information capitalization in an environment where overall country-level investor protection is relatively poor. Second, our study is one of the few, if not the first, to examine, in an emerging market, the informational effect of disaggregated of top level management ownership structure i.e. directors' stake and commissioners' stake. Finally, our study extends the underexplored connections between ownership structure 'management ownership', as one of proxies of corporate governance as argued by Asbaugh-Skaife et al. (2006) and Setyaningrum (2005), who investigate the effect of corporate governance to company's bond rating.

The remainder of the paper is structured as follows. Section 2 develops our research hypotheses. Section 3 explains how we measure stock price synchronicity in the context of the Indonesian market, and specifies our empirical models used for hypothesis testing.



Section 4 describes our sample and data sources, and presents descriptive statistics. Section 5 reports results of our main regressions, while the final section concludes the paper.

HYPOTHESIS DEVELOPMENT

One of key determinants of corporate governance is ownership structure (Shleifer and Vishny, 1997; La Porta, Lopez-de-Silanes, and Shleifer, 1998, 2000). Various prior studies were applied around the world testing the influence of board of director structure, and composition, management ownership, and capital structure on the financial performance of the corporations. In principle, the studies have two opposing views regarding management ownership in a company.

First, incentive alignment as the proponent view. Initial study of Jensen and Meckling, (1976) showed that management's equity ownership helps to resolve the agency problems and improve the corporation's performance. Jensen (1986; 1993) and Fama and Jensen (1985) add that contract of management should include the compensation which are material such as stock options, performance shares, and bonuses. Granting stock of company aims the manager to feel like the owner of the company so as to encourage management to consider its whole policy based on systematic risk and provides the best performance to maximize shareholder's wealth.

Under the incentive alignment perspective, management ownership can facilitate the alignment of interest between shareholder and management. The implication, then, is that concentrated ownership may encourage the management to voluntarily disclose more and better firm-specific information for the benefit of shareholders. This improved cost-benefit tradeoff facilitates more informed trading, which, in turn, leads to more information being impounded into stock prices (Grossman and Stiglitz, 1980). One can thus expect that under the alignment perspective, synchronicity is inversely related to management ownership, *ceteris paribus*.

Second, entrenchment incentive as the opposing view. Some studies support the view that management's equity ownership does not always have a positive effect on corporate performance (Morck, Shleifer, and Vishny 1988). Also, Fama and Jensen (1983), and Holderness (2003) demonstrate that managers who own enough stock to dominate the board



of directors could expropriate corporate wealth. Entrenched management have an incentive to cover up their self-serving, or to limit related information leakage, by withholding unfavorable information or selectively disclosing such information that helps them camouflage their self-serving behaviors, and/or opportunistically timing the release of value-relevant, private information to the market. Thus, this condition deters the flow of firm-specific information to the market, contributing to more opaque information environment. In the other hand, other investor without adequate protection may have to bear the relatively higher cost of acquiring and processing private information to overcome the information opacity, and to avoid the risk of being exploited by the management who own shares in the company. The high cost associated with private information search, however, discourages informed trading, and thus, impedes the incorporation of firm-specific information into share prices (Roll, 1988; Morck et al., 2000; Fernandes and Ferreira, 2009; Gul et al. 2010).

Gul et al. (2010) find that there is a nonlinear function of ownership concentration and synchronicity. They predict at some level of ownership, entrenchment could dominate alignment effect. This means the entrenchment effect can be mitigated, however, when ownership extends beyond a certain level and the firm assumes the characteristics of a 'private' company owned by the dominant shareholders. When the controlling owner obtains effective control of firm, any increase in voting rights does not further entrench the controlling owner, but his/her cash-flow rights in the firm mean that it will cost more to divert the firm's cash flows for private gain (Fan and Wong, 2002). Based on previous arguments, we thus test the following hypothesis and in alternative form:

H1. Stock price synchronicity initially decreases at a decreasing rate as the percentage of shares held by the management increases, but it begins to increase as the percentage continues to increase beyond a certain level, *ceteris paribus*.

MEASUREMENT OF VARIABLES AND MODEL SPECIFICATION

Measurement of Stock Price Synchronicity

To measure our dependent variable, stock price synchronicity, we need to estimate the market model, which allows us to decompose total return variations into two components:



those tied to common (market wide and/or sector/industry wide) factors and those tied to firm-specific factors. The institutional features of Indonesian markets lead us to posit one unanimous specifications of the market model from which we derive measure of synchronicity. For all share-issuing firms in our sample, we estimate the following market model for each fiscal year:

$$RET_{it} = \pi_0 + \pi_1MKTRET_t + \pi_2MKTRET_{t-1} + \pi_3SECRET_{xt} + \pi_4SECRET_{xt-1} + \varepsilon_{it} \quad (1)$$

$$RET_{it} = \frac{P_{it} - P_{it-1}}{P_{it-1}} \quad (2)$$

$$MKTRET_t = \frac{P_{mt} - P_{mt-1}}{P_{mt-1}} \quad (3)$$

Where, for firm *i* and day *t*, RET denotes the daily return on company shares traded on Indonesia Stock Exchange, shown in Eq. (2); and MKTRET and SECRET denote the value-weighted market return and industry return, respectively, shown in Eq. (3); and ε represents unspecified random factors. The market return is based on the composite (value weighted) IHSG index which reflects all stock price movements in Indonesia Exchange. The sector return (SECRET) is based on disaggregated composite published by Indonesia Stock Exchange that comprises eight index. In Eq. (1), we include lagged industry and market returns to alleviate concerns over potential non-synchronous trading biases that may arise from the use of daily returns for estimating the market model (Scholes and Williams, 1997; French, Schwert, and Stambaugh, 1987). Estimation of Eq. (1) allows us to effectively isolate total return variations tied to (domestic) market wide and industry wide factors from those tied to firm-specific factors.

In estimating Eq. 1, we follow Gul et al. (2010) that requires daily return data be available for at least 200 trading days in each fiscal year. As in other studies, stock price synchronicity is defined as the ratio of common return variation to total return variation, which is equivalent to R² of market model used. Synchronicity is often measured by the regression's R-squared value of individual stock returns on market and industry indexes. The larger R-squared an individual firm has, the more its stock prices are synchronous with market and/or industry returns. Growing number of empirical evidence supports the informational interpretation of this proxy (Boubaker et al., 2014). To circumvent the bounded nature of R² within [0,1], we use a logistic transformation of R_{*i*}²:



$$SYNCH_{iT} = \log\left(\frac{R_i^2}{1-R_i^2}\right) \quad (4)$$

where $SYNCH_{iT}$ is our empirical measure of annual synchronicity for firm i which then serves as the dependent variable.

Empirical Models for Hypothesis Testing

To test for the effects on synchronicity of management ownership in a company, the procedures is to estimate the following regression:

$$SYNCH_{iT} = a_0 + a_1MGTSTOCK_{iT} + \sum_k a_k CONTROL_{iT}^k + YRDUMMY + STRDUMMY + \varepsilon_{iT} \quad (5)$$

$$SYNCH_{iT} = b_0 + b_1COMSTOCK_{iT} + \sum_k b_k CONTROL_{iT}^k + YRDUMMY + STRDUMMY + \alpha_{iT} \quad (6)$$

$$SYNCH_{iT} = c_0 + c_1DIRSTOCK_{iT} + \sum_k c_k CONTROL_{iT}^k + YRDUMMY + STRDUMMY + \mu_{iT} \quad (7)$$

where, for firm i and year T , $MGTSTOCK_{iT}$ represents the percentages of shares held by the largest shareholder at the beginning of the fiscal year;

Following previous related researchs (Piotroski and Roulstone, 2004; Chan and Hameed, 2006; Ferreira and Laux, 2007; Gul et al., 2010), we include a total of seven control variables that are known to influence synchronicity, that is: annual trading volume turnover, trading volume computed as the total number of shares traded in a year, divided by the total number of shares outstanding at the end of the fiscal year (VOL). Firm size is computed as the log of total assets at the end of the fiscal year (SIZE). Leverage is computed as total liabilities divided by total assets (LEV). Volatility of a firm's earnings stream measured by the standard deviation of a firm's return on assets (ROA)s over the preceding five-quarter period, including the current quarter (STDROA). Market-to-book ratio is computed as the total market value of equity, divided by the total net assets at the end of the fiscal year (M/B). The number of firms in the industry to which a firm belongs is accounted with natural log of the number of firms in the industry to which a firm belongs (INDNUM). Industry size is measured as the log of year-end total assets of all sample firms in the industry to which a firm belongs (INDSIZE). Year and industry dummies are included to control for potential year and industry fixed effects. At first, we run regression of Eq. (5), (6), (7) and modify them by adding quadratic variable to test non-linearity. The resulting equations are as follows:



$$SYNCH_{iT} = d_0 + d_1MGTSTOCK_{iT} + d_2MGTSTOCK_{iT}^2 + \sum_k d_k CONTROL_{iT}^k + YRDUMMY + STRDUMMY + x_{iT} \quad (8)$$

$$SYNCH_{iT} =$$

$$e_0 + e_1COMSTOCK_{iT} + e_2COMSTOCK_{iT}^2 + \sum_k e_k CONTROL_{iT}^k + YRDUMMY + STRDUMMY + y_{iT} \quad (9)$$

$$SYNCH_{iT} = f_0 + f_1DIRSTOCK_{iT} + f_2DIRSTOCK_{iT}^2 + \sum_k f_k CONTROL_{iT}^k + YRDUMMY + STRDUMMY + z_{iT} \quad (10)$$

All of the equations are meant to test consistency between linearity and nonlinearity of price synchronicity and management ownership.

SAMPLE

Sample and Data Sources

Our sample period covers the three-year period, 2013-2015. We extract stock return, market data, and accounting data from the Datastream and from Indonesia Stock Exchange (IDX) annual fact book. Ownership-related data as to shares held by the management (pengurus perusahaan) and their identity (commissioner or director held) are manually collected, mainly from annual reports of individual companies, and in some cases supplemented from other data sources, including company web sites, the Indonesia Financial Service Authority (OJK) database. This study limits the samples to non-financial firms, since financial corporations are heavily regulated and governed by specific accounting standards, making their accounting numbers incomparable to those of other firms (Boubaker et al., 2014). Firms with insufficient ownership information or missing financial data for computing control variables were excluded from the sample. We allow firms to enter and exit the panel to limit the effect of survivorship bias. The final (unbalanced) samples comprise 739 firm-year observations.

Descriptive Statistics

Table 1 presents descriptive statistics. In the table below, R2 and SYNCH are R2 statistic and the synchronicity measures, respectively, computed from Eq. 1. The mean and



median R2 are 0.14003 and 0.05506, respectively. This means that on average 5% to 14% stock price movements of sample companies is explained by the market and the industry sectors' dynamics. These statistics are relatively incomparable to the reported mean R2 of 0.454 for China in the sample of Gul et al. (2010). The mean and median SYNCH are -2.65202 and -2.84278, respectively. The measure of SYNCH is computed using the same specification of the market model used in Gul et al. (2010), who report the mean and median of -0.232 and -0.151, respectively, which are higher than our corresponding measures. This suggests that compared with Chinese firms, stock prices of Indonesia-listed firms tend to co-move, to a lesser (greater) extent, with market wide and/or industry wide information (firm-specific information). Both R2 and SYNCH display considerable cross-sectional variations as reflected in the relatively high standard deviations and inter quantile ranges. For example, SYNCH is -4.06659 at the lower quartile, while it is -1.80695 at the upper quartile, with a standard deviation of 1.71764. Given that all firms in our sample come from a single country, this significantly high variation in synchronicity across firms suggests that the flow of firm-specific information to market varies widely across firms within the country. Table 1 also shows that, on average, the largest shareholder holds 4.02% of shares outstanding, and it reveals close to be block holder ownership structure in Indonesia.



Table 1. Descriptive Statistics

Variables	Mean	Std. Dev.	5th Pctl.	25th Pctl.	Median	75th Pctl.	95th Pctl.
R ²	0.14003	0.18278	0	0.01313	0.05506	0.12986	0.52023
SYNCH	2.65202	1.71764	9	-4.06659	-2.84278	-1.80695	0.11728
MGTSHARE	0.04018	0.12421	0	0.00000	0.00013	0.00731	0.23208
COMSHARE	0.01764	0.07177	0	0.00000	0.00000	0.00039	0.09142
DIRSHARE	0.02254	0.08586	0	0.00000	0.00000	0.00060	0.11514
VOL	0.39019	0.67961	0	0.02784	0.17133	0.42690	1.48672
SIZE	9.44833	0.67942	9	8.86636	9.44871	9.83109	7
LEV	0.51427	0.44427	1	0.30553	0.49529	0.64165	0.88882
STDROA	2.81036	8.42142	6	0.76948	1.44957	2.56518	7.83417
M/B	5	0	0	0.69750	1.41000	2.83000	8.16750
INDNUM	2.66167	0.81613	1	2.19722	2.70805	3.36730	3.82864
INDSIZE	3	0.52781	1	10.65353	10.98107	11.21753	8



Table 2A and Table 2B present the matrix of Pearson pair wise correlations between major variables and significance level. Consistent with our expectations, SYNCH is negatively correlated with our interest variable, which is partly in line with the H1. From Table 2B, we can see MGTSHARE and DIRSHARE significantly correlated with negative impact to SYNCH. In order to get affirmative correlation, the analysis proceeds to multivariate regression.



Table 2A. Correlation Matrix

	R2	SYNCH	MGT_OWNSHP	COM_OWN	DIR_OWN	VOL	SIZE	LEV	STD_ROA	M_B	INDNUM	INDSIZE
R2	1.0000	0.8930	-0.0800	-0.0232	-0.0962	0.1944	0.5574	-0.0322	-0.0837	-0.0008	-0.0116	0.1895
SYNCH	0.8930	1.0000	-0.0632	-0.0311	-0.0653	0.2355	0.5624	-0.0556	-0.0806	0.0141	-0.0458	0.1743
MGT_OWNSHP	-0.0800	-0.0632	1.0000	0.7407	0.8274	-0.0570	-0.0967	-0.0352	0.0024	0.0181	-0.0675	-0.0485
COM_OWN	-0.0232	-0.0311	0.7407	1.0000	0.2357	-0.0448	-0.0416	-0.0299	0.0238	0.0513	0.0198	0.0358
DIR_OWN	-0.0962	-0.0653	0.8274	0.2357	1.0000	-0.0450	-0.1051	-0.0259	-0.0164	-0.0167	-0.1142	-0.1001
VOL	0.1944	0.2355	-0.0570	-0.0448	-0.0450	1.0000	0.0128	0.0154	-0.0477	-0.0007	-0.0115	0.0166
SIZE	0.5574	0.5624	-0.0967	-0.0416	-0.1051	0.0128	1.0000	-0.0215	-0.0852	-0.0805	-0.0147	0.3183
LEV	-0.0322	-0.0556	-0.0352	-0.0299	-0.0259	0.0154	-0.0215	1.0000	0.3475	-0.0776	0.0294	-0.0207
STD_ROA	-0.0837	-0.0806	0.0024	0.0238	-0.0164	-0.0477	-0.0852	0.3475	1.0000	-0.0148	0.0753	0.0393
M_B	-0.0008	0.0141	0.0181	0.0513	-0.0167	-0.0007	-0.0805	-0.0776	-0.0148	1.0000	-0.1217	-0.1199
INDNUM	-0.0116	-0.0458	-0.0675	0.0198	-0.1142	-0.0115	-0.0147	0.0294	0.0753	-0.1217	1.0000	0.7121
INDSIZE	0.1895	0.1743	-0.0485	0.0358	-0.1001	0.0166	0.3183	-0.0207	0.0393	-0.1199	0.7121	1.0000

Table 2B. Correlation Matrix

Correlation					
Probability	R ²	SYNC H	MGTSHARE	COMSHA RE	DIRSHA RE
R ²	1				

SYNCH	0.893005	1			
	0.0000	-----			
		-			
		0.0631			
MGTSHARE	-0.07995	5	1		
	0.0298	0.0862	-----		
		-			
		0.0311			
COMSHARE	0.023243	4	0.740737	1	
	0.5281	0.3980	0.0000	-----	
		-			
		0.0653			
DIRSHARE	0.096229	3	0.827446	0.235677	1
	0.0089	0.0759	0.0000	0.0000	-----

RESULTS OF MULTIVARIATE REGRESSIONS

Table 3 below reports regression results for Eq. (5), (6), (7), respectively, but we leave the quadratic variable in order to only test linearity correlation. Reported t-values are not shown but rather we marked the coefficient with superscripts a, b, and c that denote the 1%, 5%, and 10% levels of significance, respectively. As seen in column H1a, the coefficient on MGTSHARE is insignificantly negative. This indicates that synchronicity decreases as management ownership increases. This is consistent with the hypotheses H1, however, the result cannot be generalized to the whole sample. We also tested separated ownership of the



management against synchronicity. The outputs are shown at Table 3, column H2b and H3c in which we can see the results consistently support the result of H1a. However, both results cannot be generalized to the whole sample.

Morck et al. (1988) finds that there is significant nonmonotonic relationship between management ownership and market valuation. Another study by Gul et al. (2010) found that there is a concave function between synchronicity and ownership. Since both studies have evidence about nonlinear relation between management ownership and price and/or synchronicity, we test our hypotheses, H1. Table 4 reports the regression result of Eq. (8), (9), (10). All of three interest variables consistently support the arguments of the nonlinear relationship. As the ownership of management rises the more synchronicity will be. Hence, management ownership can less benefit the stakeholder by less supporting the transmission of information to stock prices, for example management reduce voluntary disclosure which in turn increase synchronicity.



Table 3. Regression results of the effect of management ownership on stock price synchronicity

Variable	H1a	H2b	H3c
MGTSHARE	-0.039634		
COMSHARE		-0.092138	
DIRSHARE			-0.024774
VOL	0.561201a	0.561133a	0.562503a
SIZE	1.38007a	1.380325a	1.377385a
LEV	-0.1324	-0.132611	-0.135469
STDROA	-0.001825	-0.001804	-0.001869
M/B	0.000439c	0.000441c	0.000438c
INDNUM	-0.123513	-0.123287	-0.120364
INDSIZE	0.167298	0.167635	0.166998
YR_DUMMY	0.170036	0.170088	0.173727
STR_DUMMY	0.000517	0.00047	0.000473
C	-17.49912a	-17.50504a	-17.47914a
R-squared	0.381353	0.381359	0.380452
Adjusted R-squared	0.372855	0.372861	0.371954

The dependent variable is SYNCH(1), and is estimated using Eq. (5), (6), (7). We do not present t-values for simplicity of the table. However, we use superscripts a, b, and c that denote the 1%, 5%, and 10% levels of significance, respectively.

**Table 4. Regression Results of the Nonlinear Effect of Management
Ownership on Stock Price Synchronicity**

Variable	H1.1	H2.1	H3.1
MGTSHARE	-0.174967		
MGTSHARE^2	0.214706		
COMSHARE		-0.674816	
COMSHARE^2		1.124991	
			-
DIRSHARE			0.912988
DIRSHARE^2			1.591377
VOL	0.560908a	0.561297a	0.561414
SIZE	1.378849a	1.377835a	1.371248
			-
LEV	-0.132862	-0.133548	0.133674
STDROA	-0.001829	-0.001782	-0.00203
M/B	0.000441c	0.000449c	0.000439
			-
INDNUM	-0.124185	-0.122554	0.124613
INDSIZE	0.169642	0.167338	0.18668
YR_DUMMY	0.170248a	0.170612	0.175017
STR_DUMMY	0.000503	0.000569	0.000233
	-	-	-
C	17.50924a	17.47788a	17.61455
R-squared	0.381364	0.381465	0.380853
Adjusted R-squared	0.372003	0.372106	0.371498

The regressions also have coefficient of control variables. The VOL coefficients are significantly positive ($p < 0.00$) across all columns. This suggests that active trading hinders

the incorporation of firm-specific information into stock prices. This result is inconsistent with US finding from the study of Piotroski and Roulstone (2004). The SIZE coefficients are significantly positive ($p < 0.00$). This result indicates that stock prices of large Indonesian firms tend to mirror the market to a greater extent than do those of small firms: large firms constitute a major proportion of firms included in the market and industry indexes, and these firms are highly diversified, particularly in emerging markets such as Indonesia (Chan and Hameed, 2006). The M/B coefficients are significantly positive ($p < 0.00$), which suggest that firms with high growth potential tend to have less firm-specific information incorporated into their stock prices. The remaining coefficient estimates are insignificant in all regression.

SUMMARY AND CONCLUDING REMARKS

We investigate whether and how stock price synchronicity is associated with firm-level corporate governance characteristic unique to Indonesia. The firm-level governance variable we examine is management's ownership of shares in the company they work. In addition, we also examine the disaggregated composition of the ownership i.e. directors' share ownership and commissioners' shares ownership. This study concludes two findings.

First, we find negative correlation between our variables of interest i.e. management's shares ownership, directors' shares ownership, and commissioners' shares ownership with stock price synchronicity. This result support the view that there are two theories explaining ownership of management affect the company information environment. Second, there is concave relation between synchronicity and management ownership: as percentage of ownership increases, synchronicity decreases at a decreasing rate up to its maximum threshold, after which it begins to decrease.

This study findings provides policy implications to stock market stakeholders in developing economies such as Indonesia. An important policy objective in emerging markets is the efficient allocation of scarce capital. This objective can be better achieved when stock prices closely track firm fundamentals by reflecting all variable, firm specific information in an accurate and timely manner. In order to achieve the informational and functional efficiency of capital markets, improving firm-level governance is as important as improving country-level governance. In particular, our results suggest that the capitalization of firm-



specific information into stock prices in emerging markets could be facilitated by giving some reward or demanding management to hold some shares of the company as proposed by the classical study of Jensen and Meckling (1976). Hence, flow of information can be best reflected in stock prices.

REFERENCES

- Asbaugh-Skaife, H., Collins, D.W., LaFond, R. (2006). The effects of corporate governance on firms' credit ratings, *Journal of Accounting and Economics* 42, 203-243.
- Boubaker, S., Mansali, H., Rjiba, H. (2014). Large controlling shareholders and stock price synchronicity, *Journal of Banking & Finance* 40, 80–96.
- Chan, K., Hameed, A., (2006). Stock Price Synchronicity and Analyst Coverage in Emerging Markets. *Journal of Financial Economics*, 80, 115-147.
- Chan, K., Hameed, A., Kang, W. (2013). Stock price synchronicity and liquidity. *Journal of Financial Markets*, 16, 414-438.
- Durnev, A., Morck, R., Yeung, B., & Zarowin, P. (2003). Does greater firm-specific return variation mean more or less informed stock pricing?. *Journal of Accounting Research*, 41(5), 797-836.
- Dyah, Setyaningrum. (2005). Pengaruh mekanisme Corporate Governance Terhadap Peringkat Surat Utang Perusahaan di Indonesia. *Jurnal Akuntansi dan Keuangan Indonesia*, 2, 2, 73-102.
- Fama, Eugene F., and Michael C. Jensen. (1983). Separation of Ownership and Control. *Journal of Law and Economics*, 26 (June), 327-349.
- Fan, J., Wong, T.J., 2002. Corporate ownership structure and the informativeness of accounting earnings in East Asia. *Journal of Accounting and Economics* 33, 401–425.
- Fernandes, N., Ferreira, M.A., (2008). Does international cross-listing improve the information environment?. *Journal of Financial Economics* 88, 216–244.
- Fernandes, N., Ferreira, M.A., (2009). Insider trading laws and stock price informativeness. *Review of Financial Studies* 22, 1845–1887.
- French, K., Schwert, G.W., Stambaugh, R., (1987). Expected stock returns and volatility. *Journal of Financial Economics* 19, 3–30.



- Grossman, S., Stiglitz, J., (1980). On the impossibility of informationally efficient markets. *American Economic Review* 70, 393–408.
- Gul, Ferdinand, A., Kim Jeong-Bon, Qiu., Annie, A. (2010). Ownership concentration, foreign shareholding, audit quality, and stock price synchronicity. *Journal of Financial Economics*, 95, 425-442.
- Haggard, K., Martin, X., Perreira, R., (2008). Does voluntary disclosure improve stock price informativeness? *Financial Management* 37, 747–768.
- He, Wen., Li, Donghui., Shen, Jianfeng., Zhang, Bohui. (2013). Large foreign ownership and stock price informativeness around the world. *Journal of International Money and Finance*, 36, 211-230.
- Holderness, C.G. (2003). A Survey of Blockholders and Corporate Control. *Economic Policy Review*, Vol. 9, No. 1, April, 51-64.
- Hutton, A.P., Marcus, A.J., Tehranian, H., (2009). Opaque financial reports, R2, and crash risk. *Journal of Financial Economics* 94, 67–86.
- Jensen, M. C., Meckling, W. H. (1976). Theory of the firm: managerial behaviour, agency costs and ownership structure. *Journal of Financial Economics*, 3(4), 305-360.
- Jin, L., Myers, S., 2006. R2 around the world: new theory and new tests. *Journal of Finance* 79, 257–292.
- Kim, J.B., Shi, H., 2012. Voluntary IFRS adoption, analyst coverage, and information quality: international evidence. *Journal of International Accounting Research* 11, 45–76.
- Lang, M.H., Lins, K.V., Miller, D.P., (2004). Concentrated control, analyst following, and valuation: do analysts matter most when investors are protected least? *Journal of Accounting Research* 42, 589–623.
- La Porta, R., Lopez-de-Silanes, F., Shleifer, A., Vishny, R. (2000). Investor protection and corporate governance. *Journal of Financial Economics*, 58, 3-27.
- Lin, Jingrong, Karen., Karim, E, Khondkar., Carter, Clairmont. (2015). Why does China's stock market have highly synchronous stock price movements? An information supply perspective



- Morck, R., Yeung, B., Yu, W., (2000). The information content of stock markets: why do emerging markets have synchronous stock price movements?. *Journal of Financial Economics* 58, 215–260.
- Pindyck, R.S., Rotemberg, J.J., (1993). The comovement of stock prices. *The Quarterly Journal of Economics* 108, 1073–1104.
- Piotroski, J. D., Roulstone, D. T. (2004). The Influence of Analyst, Institutional Investors, and Insiders on The Incorporation of Market, Industry, and Firm-Specific Information into Share Prices. *The Accounting Review*, 79, 119-1151.
- Roll, R., (1988). R2. *Journal of Finance* 25, 545–566.
- Scholes, M., Williams, J., (1977). Estimating betas from nonsynchronous data. *Journal of Finance* 5, 309–328.
- Shleifer, A., Vishny, R.W., (1997). A survey of corporate governance. *Journal of Finance* 52, 737–783.
- Shleifer, A., (1998). State versus private ownership. *Journal of Economic Perspectives* 12, 133–150.
- OECD. (2012). *Board Member Nomination and Election*. OECD Publishing.
- OECD. (2015). *G20/OECD Principles of Corporate Governance*. OECD Publishing.



**THE EFFECT OF MUDHARABAH AND MUSYARAKAH ON THE
PROFITABILITY OF ISLAMIC BANKS**

Jaurino

Renny Wulandari

Economic Faculty of Panca Bhakti University

jaurino@gmail62.com

rennyusna@gmail.com

Abstract

Intention of this research is to check and test influence of defrayal of mudharabah and musyarakah to profitability at sharia banks who registered in Indonesian Bank 2013-2015 period. This research used quantitative descriptive method by using secondary data in the form of defrayal data, profit before tax and total asset of company from year of 2013-2015. Amount of sample cover publicized report continuously from year of 2013-2015 and financial statement owning equipment of data pursuant to accurate variable which taken by purposive sampling.

Analyzer test used SEM-PLS. The result show, from the data analysis it can be concluded that the Mudharabah significant effect on bank profitability while Musyarakah financing does not affect the bank's profitability. This is indicated by the value of t-statistic whereby when the t-statistic > 1.96. To reject / accept the hypothesis using all-Ha received JILA probability of p < 0.05. In this study resulted that the value of t-statistic for mudharabah was 2.16 > 1.96, then the hypothesis is accepted. As for the Musyarakah financing is -1.90 < 1.96 then the hypothesis is rejected.

Keywords: mudharabah effect, bank profitability

JEL Classifications: G21, M41

BACKGROUND RESEARCH

National Islamic banking industry continues to grow at a growth rate varies according to economic conditions and the various factors that influence its development since more than



two decades, precisely 1992. Banking Authority either when carried by Bank Indonesia and after the duty and authority of the Financial Services Authority (FSA), has consistently made efforts to encourage the development of national Islamic banking industry in order to grow up healthy, sustainable and increasingly have a positive contribution in supporting the economic development of quality.

The potential benefits of the development of Islamic banking industry for the benefit of the national economy have been widely demonstrated and perceived from the history of Islamic banking Indonesia and other countries. The development of the Islamic banking industry more quickly and to be at least a positive contribution to support financial inclusion, especially for people who want financial services that meet Islamic principles at various levels of effort. Starting from corporate business to the grassroots communities not reached by the formal financial services.

Formal financial services carried out by Islamic banks which are financing. Financing is to provide cash or by agreement between the bank and other parties are obliged to return the money or bills after a certain period of time in exchange or for the results (Rival in Purwanto, 2011)

The data ratios Return on Assets, Return on Equity and Capital Adequacy Ratio Islamic Banks finance at Bank Sharia statistics are as follows:

Table 1. Statistics Ratio of Sharia Bank

Year	Return On Assets	Return On Equity	Capital Adequacy Ratio
2014	0,41%	4,20%	15,74%
2015	0,49%	4,17%	15,02%
2016	0,46%	4,04%	15,27%

Source: Statistic of Sharia Bank in October 2016, OJK

From the above data it can be seen the bank's products provide a profit for the bank, as well as both profit and Musyarakah financing investment. The profit can be seen in the level of bank profitability as measured by the ratio of bank finance. Financial ratios used are



return on equity is the ratio of return on bank capital. From the above data is obtained is known annually for impairment ROE though not significant. The reason for using this ratio is to determine the ability of banks to manage their capital to finance the investments made by the bank Mudharabah and Musyarakah.

Based on research conducted by Kristanto (2016) on the effect of financing, Musyarakah and murabahah effect on profitability and by Jewel et al (2014) found mudharabah a negative impact and loss had a positive influence partially on the level of profitability, because there are still differences in the results obtained the researchers are interested in continuing this study with the title "the Effect of Mudharabah and Musyarakah on the profitability of Islamic Banks registered in Bank Indonesia (2013-2015 period). The Purpose of this research is to determine the effect of financing and loss to the profitability of Islamic banks registered in Bank Indonesia (Period 2013-2015).

LITERATURE REVIEW AND RESEARCH HYPOTHESIS

Relations Mudharabah and Musyarakah against Islamic Bank Profitability

Every bank in the process of doing fund raising efforts of customers who will then be managed to be channeled back to the customers who need working capital. In the management of these funds of Islamic banks in the form of financing that is profit and Musyarakah. The second financing will be profitable for the banks in the form of profit-sharing, between the banks as passive partners and clients as active partners. For the results obtained by the bank will increase its capital owned by the bank and then distributed back for further financing. The rate of return on capital can be measured by the level of bank profitability by comparing profits and capital owned bank

From the framework described above, we propose the following hypothesis:

Ha: Mudharabah financing and Musyarakah have a positive impact on the profitability of banks

Ho: Mudharabah financing and loss has a negative effect on the profitability of banks



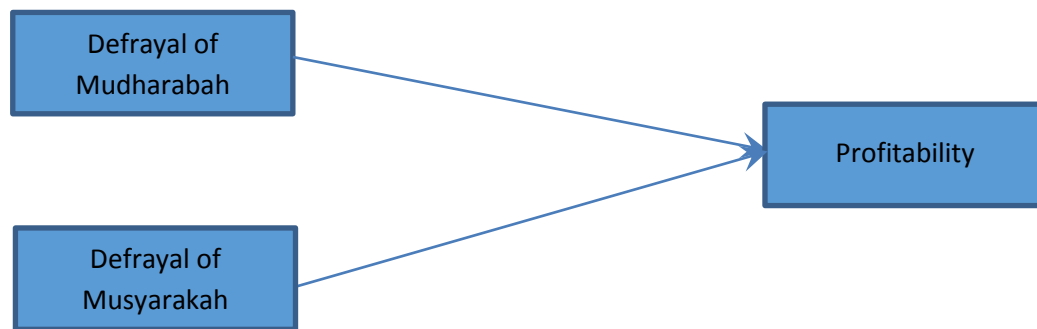

Figure 1. Research Design

Note:

X1 : Defrayal Mudharabah

X2 : Defrayal Musyarakah

Y : Profitability

Understanding Islamic Banks

Islamic banks are Islamic banks whose activities provide services in payment traffic. Associated with the operational principles of Islamic banks under section 2 of Act 21 of 2008 states that Islamic banking in conducting its business activities based on Islamic principles, economic democracy, and the precautionary principle. Furthermore, associated with the goal of Islamic banks in Article 3 which states that Islamic banking aims to support the implementation of national development in order to improve justice, solidarity and equality welfare.

The Function of Islamic Banks

In some of the literature of Islamic banking, Islamic banks with a variety of transaction scheme held in a non-usury scheme has at least four functions, namely:

1. The function of investment managers

This function can be seen in terms of fund-raising by Islamic banks, particularly Mudharabah fund. With this function Islamic bank acts as investment manager of the fund owner (shahibul maal) in this regard the fund should be channeled in a productive distribution, so that funds raised can generate profits to be shared out between the Islamic bank and the owner of the funds.



2. Function investors

In the distribution of funds, Islamic banks function as an investor (owner of the funds). As an investor, investment of funds carried out by Islamic banks must be made on productive sectors with minimal risk and do not violate the provisions of sharia. In addition, in the investing funds of Islamic banks should use investment tool in accordance with sharia. Investment in line with sharia include sale and purchase agreement (murabaha, salam and istisnaa), investment contract (Mudharabah and loss), the contract lease (Ijara and Ijara muntahiya bittamlik), and other contract allowed by sharia.

3. The social function The social function of Islamic banks is something that is inherent in Islamic banks. There are at least two instruments used by the Islamic banks in carrying out their social function, namely the instrument zakat, infaq, sadaqah and waqf (ZISWAF) and instruments qardhul hasan, instrument ZISWAF serves to collect ZISWAF of society, bank employees, as well as the bank itself as an institution belong to the investors, the funds raised through the next ZISWAF instruments distributed to the beneficiary in the form of aid or grants to meet their needs. Hasan qardhul instrument of acceptance to work to raise funds that do not meet legal criteria as well as donation and charity fund unspecified specific designation by giving. Furthermore qardhul hasan funds channeled to:

- a. Procurement or improvement of quality social facilities and community facilities (especially for funds derived from receipts that do not meet kosher criteria).
- b. Donations or grants to those entitled. Loans are prioritized on the economically disadvantaged, but have the potential and ability to return the loan.

4. The function of financial services

The function of the financial services which is run by Islamic banks is no different from conventional banks, such as providing clearing services, transfer, collections, payroll, letter of guarantee, letter of credit, and so forth. But in terms of the



mechanism of benefit of this transaction, Islamic banks still have to use the scheme in accordance with Islamic principles.

Principles of Islamic Banking Fund Distribution

The principle of investing in the financing by Islamic banks consist of investments with investment schemes with investment mudharabah and with musyarakah.

1. Investments with mudharabah

Basically the distribution of funds to the Mudharabah equal to the fund. In raising transactions, the bank is mudharib (fund manager), while customers savers / depositors are shahibul maal (owner of the funds). However, in a transaction with a Mudharabah fund distribution, bank acts as shahibul maal, while customers who receive financing acts as the fund manager. In this scheme, all capital comes from banks as shahibul maal.

Distribution of funds to the Mudharabah, composed of two types namely mutlaqah and Mudharabah Mudharabah muqayyadah. In mutlaqah mudharabah bank acts as shahibul maal authorize mudharib to run a business without bounds, types of products, customers and suppliers. Banks earn income from profit sharing ratio that is rightfully bank. As for the Mudharabah muqayyadah banks only act as an agent that connects customers muqayyadah Mudharabah investment that has set certain restrictions in investment activity by customers who receive investment Mudharabah muqayyadah. Owner of the bank's efforts to facilitate the Mudharabah funds and fund managers, banks earn a certain amount of fee that has been agreed.

2. Investment with Musyarakah Schemes

Investment schemes are investment cooperation Musyarakah capital owners who mix their capital in certain business with profit sharing based on a ratio agreed in advance, whereas in case of loss is borne by the owners of capital based on the portion of capital respectively. In this scheme the relationship between the bank and its customers financing is a partnership among the owners of capital. In this case the bank and partners are equally providing capital to finance a particular



effort both existing and new runs. Furthermore, partners can restore the capital along with the results that have been agreed the ratio gradually or all at once to the bank.

3. Profitability

Profitability is the company's ability to generate profits. The profit derived from its capital and assets (Syamsudin, 2011).

METHODOLOGY

Research Design

This research is quantitative. Can be interpreted as a method of research that is based on the philosophy of positivism, is used to examine the population or a particular sample, sampling technique is generally done at random, data collection using research instruments, quantitative data analysis / statistics with the aim to test the hypothesis set (Sugiyono 2007).

Types and Sources of Data Research

Data used in this research is secondary data, the annual report sharia banks in 2013-2015. These data will be obtained from the official website www.bi.go.id and Islamic banks.

Quantitative data are required in this study are:

- a. List of Islamic banks registered in Bank Indonesia from 2013 to 2015.
- b. Islamic commercial bank financial statements contained therein accounts of financing and Musyarakah financing.
- c. Data financial ratios, particularly the ratio of profitability.

Population and Sample

The population in this study is an Islamic commercial bank registered in the Islamic Banks in 2013 to 2015. The sample in this study using the sampling nonprobability sampling technique that does not give opportunity / equal opportunity for each element or member of the population to be selected into the sample , In this study population is full of samples taken for testing then use the sampling saturated sample when all members of the population used



as a sample. This is often done when the population size is relatively small, less than 30. Or research to make generalizations with a very small error. (Sugiyono, 2010)

Data Collection Technique

The data collection technique is a way or path that is used by researchers to collect the data in the study. In this research is done by using the following techniques:

a. Documentation

Which is seeking information from the documents associated with the object under study. In this study the documents used are the financial statements on every Islamic banks registered at Bank Indonesia.

b. Literature study

Studying the literature dealing with the problems examined to obtain secondary data.

Variables Research and Operational Definitions

In this analysis using a dependent variable (dependent) variable and is not bound (independent). The dependent variable is a variable that is influenced by other variables, while the independent variables are variables that are not influenced by other variables. The dependent variable here is the profitability, whereas the independent variable is Mudharabah and Musyarakah financing.

The following operational definition of each variable research and measurement:

Draft Test Hypothesis

To test the truth of the hypothesis, then tested the hypothesis tested and proven influence on the profitability of bank financing. The hypothesis being tested is the null hypothesis (H₀) while (H_a) is an alternative hypothesis in this study.

The analysis in this study will use the Partial Least Square (PLS). Modelini treat profitability and financing as latent variables with each of the indicators in each variable. PLS is a method for implementing the Structural Equation Modeling (SEM) for present purposes is considered preferable since this model was developed as an alternative to situations where



the basic theory of weak and on designing models or indicators available do not meet reflective measurement models. PLS is an excellent analytical method because it can be applied at all scales of the data, does not require a lot of assumptions and should not be large sample size (Ghazali, 2006).

Based on the model of hypothesis testing that has been mentioned above, in accordance with the methods of analysis and conceptual model, it can be made a model of path analysis all latent variables in PLS consists of (Ghazali, 2015):

1. Outer model, which specifies relationship between the latent variables (structural model).
2. Inner model, which specifies relationship between the latent variables with the indicator (Measurement Model).

Analysis on PLS done in three stages:

1. Analysis of the model outer performed to ensure that the measurement used to be a decent measurement (valid and reliable). Analysis outer model can be seen from several indicators:
 - a. convergent validity
 - b. discriminant validity
 - c. unidimensional
2. While analysis of the inner workings of the model / structural analysis models to ensure that the structural model is built robust and accurate. Inner evaluation model can be seen from several indicators which include:
 - a. Determinant coefficient (R²)
 - b. Predictive Relevance (q²)
 - c. Goodness of Fit Index (Gof)
3. To test the hypothesis made by looking at the probability value and t-statistics. For a probability value, p-value with an alpha of 5% is less than 0.05. T-tailed value for alpha of 5% was 1.96. So the hypothesis acceptance criteria is when the t-statistic > t-table.



ANALYSIS AND DISCUSSION

Data analysis

Outer Analysis Model

- a. Convergent validity is the factor loading values with the indicator latent variables > 0.7. In this study all CV values above 0.7 except R3

	X1	X2	X3
Md_1	0,92207 4		
Md_2	0,95737 1		
Md_3	0,77810 9		
Mr_1		0,99328 1	
Mr_2		0,99083 0	
Mr_3		0,98979 7	
R_1			0,93422 5
R_2			0,93533 7
R_3			0,46475 5
X1	0,91913 3		
X2		0,99939 7	
Y			0,99157 2



a. Value of discriminant validity

	X1	X2	X3
Md_1	0,92207 4	0,79093 5	0,32389 2
Md_2	0,95737 1	0,93655 6	0,42696 4
Md_3	0,77810 9	0,84471 1	- 0,04119 4
Mr_1	0,90879 1	0,99328 1	0,09191 9
Mr_2	0,89430 8	0,99083 0	0,05645 5
Mr_3	0,95035 9	0,98979 7	0,15125 4
R_1	0,66471 1	0,42861 0	0,93422 5
R_2	0,40965 7	0,17640 2	0,93533 7
R_3	- 0,43866 5	- 0,63330 3	0,46475 5
X1	0,91913 3	0,92677 9	0,12810 8
X2	0,92540 5	0,99939 7	0,10070 9
Y	0,28747 5	0,00729 8	0,99157 2

b. Composite Reliability > 0,7

	Composite Reliability
X 1	0,942326
X 2	0,996644
X 3	0,913068

c. AVE (Average Variance Extracted) > 0,5

	AVE
X 1	0,80426
X 2	0,98671
X 3	0,73671

d. Cronbach alpha > 0,6

	Cronbachs Alpha
X 1	0,943034
X 2	0,995927
X 3	0,861518

For formative indicators do different testing are:

1. Significance of weights, the value must be significantly
2. Multicollinearity, by looking at the value between 5-10 VIF

Inner Testing Model

Evaluation inner model can be done by looking at R2:

X	R Square
1	
2	
3	0,61881
3	3

Here's inner testing the model by looking at Q2 by the formula

$$Q2 = 1 - (1 - 0,618813)$$

$$Q2 = 0,38187$$

The latter by finding the value of GoF. Tenenhaus (2004) in Kritanto (2006)

$$GoF = \sqrt{AVE \times R^2}$$

$$GoF = 0,58345 \times 0,618813 = 0,3610$$

Tenenhaus (2004) nilai GoF small = 0,1, medium = 0,25 dan besar = 0,38

Hypothesis Testing

Test the hypothesis can be seen from the value of t-statistics and probability value. To test the hypothesis using the statistical value of 5% alpha value of t-statistic used was 1.96, so the criteria for acceptance / rejection was received and H_0 H_a rejected when the t-statistic > 1.96. To reject / accept the hypothesis using all- H_a received JILA probability $p < 0.05$



Total Effect

	X 1	X 2	X3
X 1			2,16374 6
X 2			- 1,90649 7
X 3			

The result is Mudharabah significant effect on bank profitability while Musyarakah financing does not affect the bank's profitability.

DISCUSSION

Relations Mudharaba and Musyarakah against Islamic Bank Profitability.

Every bank in the process of doing fund raising efforts of customers who will then be managed to be channeled back to the customers who need working capital. In the management of these funds of Islamic banks in the form of financing that is profit and Musyarakah. The second financing will be profitable for the banks in the form of profit-sharing, between the banks as passive partners and clients as active partners. For the results obtained by the bank will increase its capital owned by the bank and then distributed back for further financing. The rate of return on capital can be measured by the level of bank profitability by comparing profits and capital owned bank.

Criteria for acceptance / rejection was received and H_0 H_a rejected when the t-statistic > 1.96. To reject / accept the hypothesis using all- H_a received JILA probability of $p < 0.05$. In this study resulted that the value of t-statistic for mudharabah was $2.16 > 1.96$, then the hypothesis is accepted. As for the Musyarakah financing is $-1.90 < 1.96$ then the



hypothesis is rejected. The result is Mudharabah significant effect on bank profitability while Musyarakah financing does not affect the bank's profitability.

Contrary to the results of research Kris (2016) on the effect of financing, Musyarakah and murabaha effect on profitability and by Jewel et al (2014) found Mudharabah a negative impact and loss partially positively influence the level of profitability.

CONCLUSIONS AND IMPLICATIONS

Conclusion

From the data analysis it can be concluded that the Mudharabah significant effect on bank profitability while Musyarakah financing does not affect the bank's profitability. This is indicated by the value of t-statistic whereby when the t-statistic > 1.96. To reject / accept the hypothesis using all-Ha received JILA probability of $p < 0.05$. In this study resulted that the value of t-statistic for mudharabah was $2.16 > 1.96$, then the hypothesis is accepted. As for the Musyarakah financing is $-1.90 < 1.96$ then the hypothesis is rejected.

Implication

1. It is expected that further research adds to the source of research data and add variables that affect the financial performance of Islamic banks.
2. This study is expected to contribute that the funding committed by Islamic banks do not affect the profitability of the banks but which may affect the profitability of banks chances are good name of Islamic banks and government policy in supporting economic development in general sharia Islamic banks in particular.

REFERENCES

Ghazali, (2015). Structural Equation Modelling. Alternative Method. Diponegoro University. Semarang.



- Kristanto Bagas Alif, (2016). Effect of Mudharabah, Musyarakah, Murabaha to Profitability in BRI Sharia Indonesia (BRI Sharia Empirical Study in Indonesia in 2011-2014) Faculty of Economics and Business, Muhammadiyah University, Surakarta.
- Permata, et al, (2014). Analysis of Effect of Mudharabah and Musyarakah to the level of profitability (Return On Equity) (Studies in Islamic Banks Registered in Bank Indonesia Period 2009-2012).
- Subramanyam, K.R. & John J. Wild. (2010). Analysis of Financial Report (Financial Statement Analysis) Edition 10-Book1. Salemba Empat. Jakarta.
- Suliyanto. (2011). Applied Econometrics: Theory and Applications with SPSS. CV. Andi Offset. Yogyakarta.
- Syamsudin, Lukman. (2011). Corporate Financial Management (Concept Applications in Planning, Monitoring and Decision Making) New Edition. Jakarta: PT. Raja Grafindo Persada.
- Yaya, Rizal. Dkk. (2009). Islamic Banking Accounting (Theory and Practice of Contemporary) Salemba Empat. Jakarta.



FOREIGN HOLDING COMPOSITION AND EXCHANGE RATES IN INDONESIA

Datu Beru

Irwan Adi Ekaputa

Universitas Indonesia

berudatu@gmail.com

Abstract

This paper contributes to the portfolio investment and exchange rates dynamics literature in a small open economy, the Indonesia market, by investigating the joint dynamics of foreign holding composition and exchange rates that is considered as a vital issue for investors and policy maker. Indonesia Central Securities Depository (KSEI) classifies foreign holding composition into nine categories—corporation, individual, mutual fund, securities company, insurance, pension fund, financial institution, fondation, and others. For this purpose, Vector Error Correction model, Vector Autoregression (VAR) framework, and granger causality are used to assess the dynamic relationships among foreign short-term portfolio ownership, in equity, local currency corporate and government bonds, and exchange rates. The analyzed time-span is 2009-2016 and this paper employs monthly data of foreign holding of Indonesia financial assets and the exchange rate. The results show that there exists a unidirectional causality that runs from foreign corporate, mutual fund, insurance, and pension fund ownership to exchange rates, in the long-term. In the short-term, there is a unidirectional causality that runs from foreign ownership under corporate, mutual fund, and other categories to current exchange rates. In general, the results show that foreign institutional ownership of Indonesia financial assets affect exchange rates both in the long and short term, which is the first time this has been investigated.

Keywords: Foreign holding composition, exchange rates, Vector Error Correction Model, Vector Autoregression, Granger Causality

JEL Classifications: E49, G32



INTRODUCTION

International capital flows play an important role as a source of capital, technology, and managerial expertise for small open economies like Indonesia. However, a sudden large capital inflow causes domestic currency to appreciate which, in turn, can decrease a country's net exports performance (Bakardzhieva et al, 2010). Therefore, extreme inflows of capital have posed challenges for policy makers in emerging markets (Calvo, 1998; Edwards, 2000). In recent years, many emerging markets have experienced a rise in foreign capital inflows since the global financial crisis in 2008. In response to the crisis, throughout 2008-2014, several developed markets implemented quantitative easing and zero lower bound as a policy rates which led capital to flow to emerging markets with higher returns. Indonesia is one of the emerging markets that has been favored by short-term foreign investors. As seen in below charts, starting from 2001 to 2016, there is a significant increase in the amount of FPI (Foreign Portfolio Investment) in Indonesia. In consequence, foreign ownership accounted for the largest portion of portfolio investment in Indonesia.

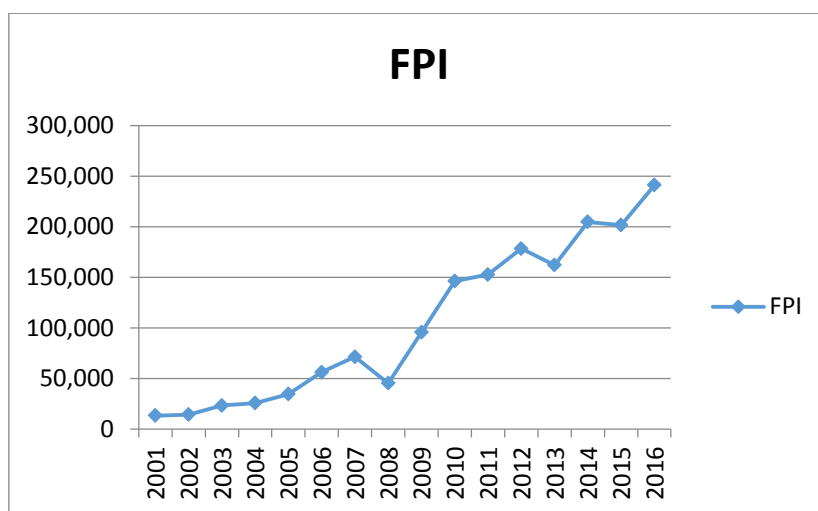

Figure 1. FPI in Indonesia in million USD (Bank Indonesia, 2001-2016)

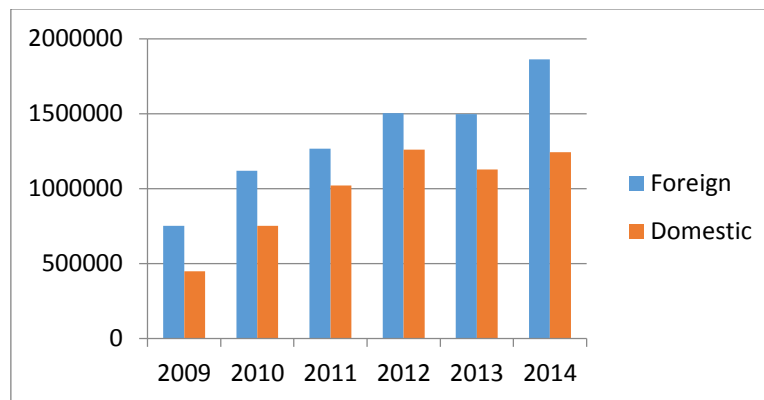

Figure 2. Composition of foreign and domestic holding of Indonesia financial assets in billion IDR (KSEI, 2009-2014)

The increasing amount of foreign capital inflows to Indonesia can be traced back to 1980s when Indonesia first liberalized its financial sector in order to spur economic growth. In 1980s, FDI (Foreign Direct Investment) was the largest type of capital inflows in Indonesia. However, after Asian crisis in 1998, foreign investors shifted their preference into portfolio investment. FPI increases domestic capital markets liquidity and facilitates the use of new instruments for diversification. However, on the other hands, this type of capital flows is volatile since it has short-term investment horizon characteristic. Some studies have found that portfolio investment is the most volatile type of capital flows with direct investment is the least volatile (Sarno and Taylor, 1999a, 1999b; Bird and Rajan, 2000).

Empirically, many studies have found the relationship between portfolio investment and exchange rates in emerging markets (Edwards, 1998; Kim and Singal, 2000; Jongwanich, 2010). FPI (Foreign Portfolio Investment) has experienced a significant increase in which foreign holding of Indonesia financial assets, chiefly in stocks, corporate and government bonds, have become more significant. Also, there has been a concern pertaining the effects of the growing foreign ownership of Indonesia financial assets, mainly by foreign institutions. According Dornbusch (1980), it is known that there is an equilibrium relationship between foreign holding of a country's assets and the price of assets in different currencies. Hence, it can be intuitively said that assets held by foreign investors determine exchange rates. In other words, it seems reasonable to assume that the foreign holding of Indonesia financial assets should affect exchange rates.

In short, foreign holding composition is chosen for this analysis for two reasons. First, foreign portfolio investment is more volatile than other types of capital flows because of its temporary nature. Therefore, it is likely to pose some challenges to monetary policy. Second, the relationships between exchange rates and aggregate capital flows have received much research attention, leaving a gap on the role of foreign holding composition, which consists of nine categories of foreign ownership of Indonesia financial assets, on exchange rates fluctuations, and vice versa. Vector Error Correction model, Vector Autoregression (VAR) framework, and granger causality are used to assess the dynamic relationships among foreign short-term portfolio ownership, in equity, local currency corporate and government bonds, and exchange rates. The analyzed time-span is 2009-2016 and this paper employs monthly data of foreign holding of Indonesia financial assets and the exchange rate. The paper finds that there exists a unidirectional causality that runs from foreign corporate, mutual fund, and insurance ownership to exchange rates, in the long-run. In the short-run, there is a unidirectional causality that runs from foreign ownership under other category to current exchange rates.

DATA AND METHODOLOGY

Data

Previous studies have shown that there is a rise in international capital flows to emerging markets during rounds of QE program undertaken by the Fed throughout 2008-2014. Therefore, this paper uses monthly secondary data of foreign holding composition in equity, corporate bonds, and government bonds and exchange rates with the analyzed time-span is 2009-2016, corresponding to all rounds of QE by the Fed. Monthly frequency data are used as to higher data frequency may include too much noise. Sum of reported foreign holding of Indonesia financial assets and nominal exchange rate are derived from KSEI and Datastream, respectively.

The summary statistics is presented in Tabel 1. Some interesting observations can be inferred from the table. Technically, the standard deviation is a measure of dispersion in a series and a large S.D. implies higher volatility. However, in the literature, high volatility has



been associated with conditions in which foreign investors get into a market for short periods of time and withdraw their investments if there is a slight change in the market that is not favorable to them. It can be seen from the table that insurance records as the highest volatility in foreign holding category and financial institution records the lowest. Meanwhile, others hold the largest portion of Indonesia financial assets.

Table 1. Summary Statistics

Stats	Obs	Mean	S.D.	Min.	Max	Exp. Sign	Definition and description
EXC	92	9.27	0.16	9.04	9.59		Nominal exchange rate, expressed as the ratio of IDR to USD. Monthly frequency, end-of-period values—expressed in natural log.
COR	92	12.48	0.59	10.64	12.94	-	Sum of reported corporate foreign holding of Indonesia financial assets(liabilities). Monthly frequency, end-of-period values—expressed in natural log.
IND	92	9.44	1.03	7.33	11.20	-	Sum of reported individual foreign holding of Indonesia financial assets (liabilities). Monthly frequency, end-of-period values—expressed in natural log.
MF	92	12.09	1	7.68	12.83	+	Sum of reported mutual fund foreign holding of Indonesia financial assets (liabilities). Monthly frequency, end-of-period values—expressed in natural log.
SC	92	11.06	0.76	7.29	12.50	+	Sum of reported securities company foreign holding of Indonesia financial assets (liabilities). Monthly frequency, end-of-period values—expressed in natural log.
INS	92	8.94	1.23	5.66	10.15	+	Sum of reported insurance foreign holding of Indonesia financial assets (liabilities). Monthly frequency, end-of-period values—expressed in natural log.
PF	92	10.83	1.15	6.85	11.87	+	Sum of reported pension fund foreign holding of Indonesia financial assets (liabilities). Monthly frequency, end-of-period values—expressed in natural log.
							Sum of reported financial institution foreign holding

FI	92	12.58	0.23	11.55	13.14	-	of Indonesia financial assets (liabilities). Monthly frequency, end-of-period values—expressed in natural log.
FON	92	7.74	0.46	6.91	8.54	+	Sum of reported fondation foreign holding of Indonesia financial assets (liabilities). Monthly frequency, end-of-period values—expressed in natural log.
OTH	92	12.90	0.25	12.37	13.32	+	Sum of reported others foreign holding of Indonesia financial assets (liabilities). Monthly frequency, end-of-period values—expressed in natural log

Table 2 shows the correlations between foreign holding composition and exchange rates. From the result, it can be seen that correlation coefficients between the nine categories of foreign ownership and exchange rates are all positive in values, meaning that foreign ownership of Indonesia financial assets and exchange rates is positively correlated. However, the level of correlation coefficients for some categories of foreign ownership are not strong--the correlations are very weak for individuals and financial institutions.

Table 2. Correlation Matrix for Foreign Holding Composition and Exchange Rates

	EXC	COR	IND	MF	SC	INS	PF	FI	FON	OTH
EXC	1									
COR	0.38	1								
IND	0.02	0.85	1							
MF	0.61	0.93	0.69	1						
SC	0.78	0.41	0.07	0.64	1					
INS	0.56	0.94	0.75	0.97	0.58	1				
PF	0.71	0.89	0.64	0.97	0.68	0.97	1			
FI	0.03	-0.47	-0.68	-0.29	0.06	-0.47	-0.37	1		
FON	0.78	0.7	0.37	0.85	0.7	0.81	0.88	-0.07	1	
OTH	0.70	0.58	0.35	0.69	0.39	0.63	0.73	0.03	0.8	1



Figure 3 Presents a visual display of the basic relationship between monthly foreign holding composition and exchange rates across time, in logs. It also indicates a trend in which foreign holding of Indonesia financial assets is initially sluggish, in 2009, and then gradually become pronounced after 2010.

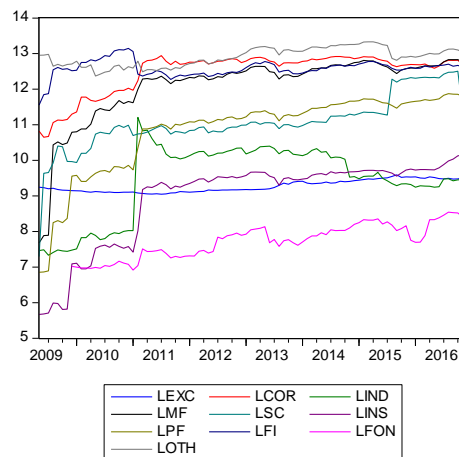

Figure 3. Co-movements Between Foreign Holding Composition and Exchange Rates

In order to investigate whether structural breaks exist in exchange rate data series, the CUSUM test is employed. This test basically a cumulative sum of recursive residuals. The CUSUM test on exchange rates shows that there is variance instability. One-step forecast test is then conducted in order to identify the specific points of break in the data series. The one-step forecast test graph shows that Indonesian nominal exchange rates has multiple breaks over the study period. Results for both tests are shown in the following Figure 4.

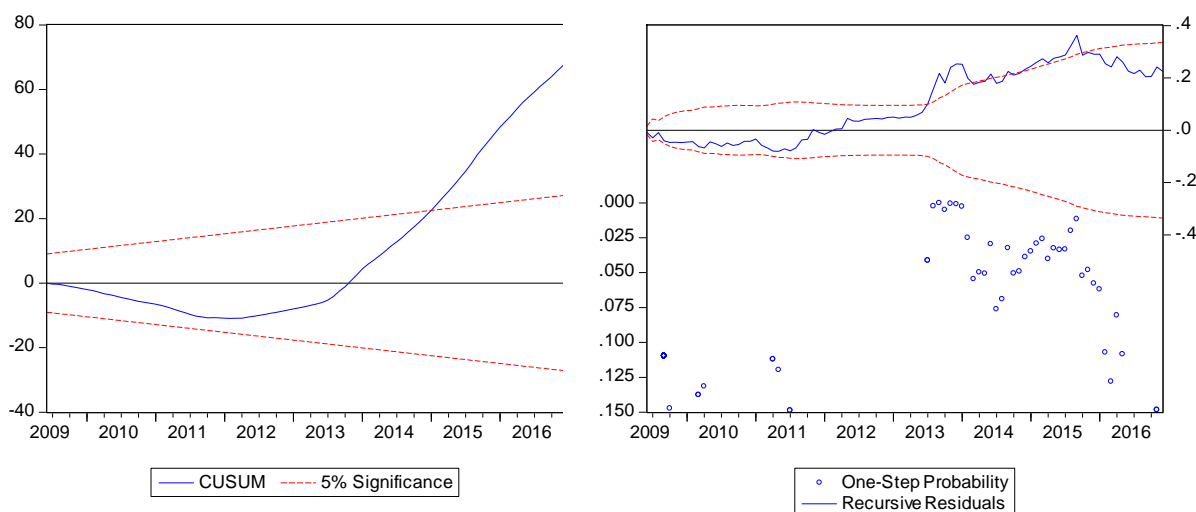

Figure 4. Structural break tests results for monthly nominal exchange rates series

Methodology

Firstly, it is important to test data stationarity using Augmented Dickey-Fuller test (ADF) and Phillip-Perron in order to avoid spurious regression. The following regression is ADF test.

$$\Delta Y_t = \delta_1 + \delta_2 t + \alpha Y_{t-1} + \beta_i \sum_{i=1}^m \Delta Y_{t-1} + \varepsilon_t \quad (2.1.)$$

Where, Δ is the difference operator. δ_1 , δ_2 , and β_i are the coefficients. ε_t is the white noise error term.

The PP test regression:

$$\Delta Y_t = \beta_1 + \beta_2 Y_{t-1} + \varepsilon_t$$

Where, Δ is the difference operator. Y_{t-1} is the first lag of Y.

Secondly, if a set of variables has a stationary linear combination, then it is considered to be a cointegration which shows a long-term relationship between variables. To test cointegration, Johansen cointegration test is used in which it can estimate more than one cointegrating vector between variables.

Thirdly, when there is an absence of any cointegrating vector between variables, the granger causality test is used to find the causal relationship among variables tested. More precisely, this test is used to investigate whether past information of x improves the forecast of y. In order to obtain this kind of link, an unrestricted VAR estimation is used to determine the

dynamic relationships of random disturbances between variables. According to Sims (1980), there are no prior restrictions in determining exogenous and endogenous variables in a VAR model due to minimal assumptions regarding to the underlying structure of the economy. Following Edwards (1998), this paper attempts to investigate the dynamic relationships between foreign holding of Indonesia financial assets and exchange rates using an unrestricted VAR estimations. One might be interested in knowing whether foreign holding of Indonesia financial assets provides any additional information that can explain the fluctuations in exchange rates.

$$\begin{bmatrix} FPI_{it} \\ ER_{it} \end{bmatrix} = \begin{bmatrix} \alpha_{10} \\ \alpha_{20} \end{bmatrix} + \begin{bmatrix} \phi_{11}(L) & \phi_{12}(L) \\ \phi_{21}(L) & \phi_{22}(L) \end{bmatrix} \cdot \begin{bmatrix} FPI_{i,t-1} \\ ER_{i,t-1} \end{bmatrix} + \begin{bmatrix} \varepsilon_{it}^{FPI} \\ \varepsilon_{it}^{ER} \end{bmatrix} \quad (2. 2.)$$

Where FPI_{t-1} represents lagged values of foreign portfolio investment which consists of nine categories of foreign holding of Indonesia financial assets; ER_{t-1} represents lagged values of nominal exchange rates; the error term ϕ_1 and ϕ_2 are parameters to be estimated; the error terms ε_{it}^j ($j= FPI, ER$) are assumed to be normally distributed with mean 0; α_{j0} are foreign ownership categories constants and ϕ_{jk} ($k= 1, 2$) are parameters to be estimated, for all $i=1, \dots, N$; $t=1, \dots, T$; L is the lag operator. For each foreign ownership category i , the variance-covariance matrix is:

$$\Sigma_i = \begin{pmatrix} \sigma_{i,FPI}^2 & \rho\sigma_{i,FPI}\sigma_{i,ER} \\ \rho\sigma_{i,FPI}\sigma_{i,ER} & \sigma_{i,ER}^2 \end{pmatrix} \quad (2. 3.)$$

Where, ρ is the correlation coefficient between the two error terms for each foreign ownership category i . The diagonal coefficients ϕ_{11} and ϕ_{22} capture how far each variable can be predicted by its own lagged values. The off-diagonal coefficients ϕ_{12} and ϕ_{21} capture the dynamic relationships between the two variables, indicating causality. The lag length of the unrestricted VAR is determined by looking at the AIC and SIC.

However, if cointegration exists between foreign holding composition an exchange rates, it means that long-term relationship exists. Therefore, it is suitable to use a VEC model since it captures the causality between variables tested with a long-term relationship.

$$\begin{bmatrix} FPI_{it} \\ ER_{it} \end{bmatrix} = \begin{bmatrix} \alpha_{10} \\ \alpha_{20} \end{bmatrix} + \begin{bmatrix} \phi_{11}(L) & \phi_{12}(L) \\ \phi_{21}(L) & \phi_{22}(L) \end{bmatrix} \cdot \begin{bmatrix} FPI_{i,t-1} \\ ER_{i,t-1} \end{bmatrix} + \begin{bmatrix} k_1 ect_{i,t-1}^{FPI} \\ k_1 ect_{i,t-1}^{ER} \end{bmatrix} \begin{bmatrix} \varepsilon_{it}^{FPI} \\ \varepsilon_{it}^{ER} \end{bmatrix}$$

Where, ect_{it}^j ($j=FPI, ER$) is the error term



EMPIRICAL RESULTS

Unit Root Tests

The following Table 3 presents the results of the ADF and PP tests. The null hypothesis of these tests is that a unit root exists in the data series. At the data levels, the t-Statistics for EXC, IND, FON, and OTH are less negative than their critical values at the 5% level. Therefore, the null hypothesis cannot be rejected. In other words, the data series of these four variables are non-stationary at the data level and they will be stationary using first difference. However, at the data level, the t-Statistics for COR, MF, SC, INS, PF, and FI are more negative than their critical values at 5% level. It means that the null hypothesis can be rejected—the data series are stationary. However, observing the ACF plot is as important as unit root tests for identifying non-stationarity time series. Figure 3 presents ACF plots for all data series. It can be seen that ACF decreases slowly to zero, meaning that all data series is non-stationary and will be stationary using first difference. Corresponding to the ACF plots, it is determined that all data series are non-stationary. Therefore, Johansen cointegration test is suitable to use since the precondition of this test is that variables must be non-stationary at level.

Table 3. ADF Unit Root Test

Variables	ADF			PP		
	Levels	5% Critical Values	First differences	Levels	5% Critical Values	First differences
EXC	0.0006	-2.89	-9.43	-0.09	-2.89	0.94
COR	-4.13	-2.89	-7.63	-3.6	-2.89	-7.6
IND	-2.22	-2.89	-10.43	-2.18	-2.89	-10.42
MF	-5.72	-2.89	-9.18	-7.68	-2.89	-9.18
SC	-5.95	-2.89	-14.9	-5.42	-2.89	-15.4
INS	-3.89	-2.89	-8.37	-4.71	-2.89	-8.3
PF	-4.55	-2.89	-8.83	-8.89	-2.89	-8.83
FI	-4.18	-2.89	-8.48	-4.84	-2.89	-8.47
FON	-1.35	-2.89	-9.19	-1.34	-2.89	-9.2
OTH	-1.67	-2.89	-11.4	-1.53	-2.89	-11.4



Table 4. Correlogram for Monthly Foreign Holding of Indonesia Financial Assets and Exchange Rates

Variables	Level				First Difference			
	Autocorrelation	Partial Correlation	AC	PAC	Autocorrelation	Partial Correlation	AC	PAC
EXC	. *****	. *****	0.980	0.980	-0.006	-0.006
	. *****	. .	0.959	-0.051	-0.005	-0.006
	. *****	. .	0.940	0.062	. *	. *	0.164	0.164
COR	. *****	. *****	0.941	0.941	. **	. **	0.224	0.224
	. *****	. *.	0.865	-0.175	. *.	. *.	-0.107	-0.166
	. *****	. .	0.791	-0.002	. .	. *	0.028	0.101
IND	. *****	. *****	0.923	0.923	. *.	. *.	-0.106	-0.106
	. *****	. .	0.857	0.041	0.019	0.008
	. *****	. *.	0.780	-0.068	-0.045	-0.042
MF	. *****	. *****	0.851	0.851	0.022	0.022
	. *****	. .	0.707	-0.062	0.011	0.011
	. ****	. *.	0.559	-0.098	0.004	0.003



	. *****	. **	0.532	0.349	. *	. *	0.107	0.107
	. *****	. .	0.500	-0.051	0.024	0.019
SC	. *****	. *****	0.785	0.785	0.017	0.017
	. *****	. **	0.730	0.296	0.042	0.042
	. *****	. *	0.663	0.077	. *	. *	0.095	0.094
INS	. *****	. *****	0.934	0.934	. *	. *	0.113	0.113
	. *****	. * .	0.864	-0.071	** .	** .	-0.233	-0.249
	. *****	. .	0.800	0.018	* .	. .	-0.066	-0.006
PF	. *****	. *****	0.912	0.912	0.060	0.060
	. *****	. * .	0.821	-0.068	* .	* .	-0.154	-0.158
	. *****	. .	0.733	-0.029	0.018	0.039
FI	. *****	. *****	0.772	0.772	. *	. *	0.132	0.132
	. *****	. * .	0.570	-0.066	. *	. *	0.101	0.085
	. **	. * .	0.347	-0.178	0.021	-0.003
	. **	. *	0.254	0.165	* .	* .	-0.116	-0.130
	. *	. .	0.202	0.043	-0.024	0.004

FON	. *****	. *****	0.936	0.936	-0.021	-0.021
	. *****	. .	0.871	-0.040	-0.032	-0.033
	. *****	. .	0.802	-0.065	-0.055	-0.056
	. *****	. .	0.736	-0.019	-0.061	-0.065
	. *****	. .	0.672	-0.020	0.021	0.015
OTH	. *****	. *****	0.936	0.936	. * .	. * .	-0.193	-0.193
	. *****	. *	0.895	0.158	0.034	-0.003
	. *****	. .	0.849	-0.033	0.031	0.039

Johansen Cointegration Test

The result of ADF tests indicate that all data series are integrated in order 1. Therefore, the Johansen cointegration test is used to test whether there is any cointegrating equation between exchange rates and each foreign holding composition category.

Table 5

Foreign Ownership Categories	Eigenvalue	Hypothesized No. Of CE(s)	Trace Stats	5% Critical Value	Hypothesized No. Of CE(s)	Max-Eigen Stats	5% Critical Value
Corporate	0.18	None*	20.56	15.49	None*	18.42	14.26
	0.02	At most 1	2.14	3.84	At most 1	2.14	3.84
Individual	0.1	None	11.32	15.49	None	10.45	14.26



Mutual Fund	0.35	None*	40.11	15.49	None*	39.88	14.26
	0.002	At most 1	0.23	3.84	At most 1	0.23	3.84
Securities Company	0.11	None	11	15.49	None	11	14.26
Insurance	0.15	None*	16	15.49	None*	15	14.26
	0.01	At most 1	0.98	3.84	At most 1	0.98	3.84
Pension Fund	0.26	None*	28.58	15.49	None*	27.92	14.26
	0.007	At most 1	0.66	3.84	At most 1	0.66	3.84
Financial Institution	0.22	None*	22.44	15.49	None*	22.44	14.26
	0.00007	At most 1	0.0006	3.84	At most 1	0.0006	3.84
Fondation	0.1	None	8.97	15.49	None	8.95	14.26
Others	0.13	None	13.2	15.49	None	12.48	14.26

Table 5 Trace tests show that there is no cointegrating equation at the 5% level. However, max-eigen tests show that there is 1 cointegrating equation at the 5% level for mutual fund. * denotes rejection of the null hypothesis.

Table 5 shows the result of trace and max-eigen tests for all series. The null hypothesis of the Johansen cointegration test is that there is no cointegrating vector. The null hypothesis can be rejected if trace and max-eigen statistics is more than the 5% critical value. In this case, these tests results for some foreign ownership categories, namely corporate, mutual fund, insurance, pension fund, and financial institution, show that there is 1 cointegrating vector at the 5% level--meaning that there is a long-term relationship between those foreign ownership categories and exchange rates. Since there is a cointegrating vector, VEC estimation is applied to capture the long-term causality between foreign corporate, mutual fund, insurance, pension fund, and financial institution ownerships and exchange rates. On the other hand, the results of foreign ownership categories which are individual, securities company, fondation, and others show that their trace and max-igen statistics are less than the 5% critical value. Therefore, it can be inferred that there is no cointegrating vector, meaning that there is no long-term relationship between those foreign ownership categories and exchange rates. In this case, a VAR model is applied to capture the short-term

relationships between foreign individual, securities company, fondation, and other ownerships and exchange rates.

The Vector Error Correction Model Causality Test

Since there is a contegrating vector in some foreign ownership categories, namely corporate, mutual fund, insurance, pension fund, and financial institution, a VEC model is applied. The first step in using this model is choosing the optimal lag length which is very crucial for the next processing steps. The data level is used in VEC model because it is capable to transform data level automatically to first difference. From table 6, it can be seen that, for all foreign ownership categories, the optimal lag length is 1. Therefore, one lag will be included within the VAR estimation of those five foreign ownership categories.

Table 6. The Number of Optimal Lag Length Using AIC And SIC

Foreign Ownership Categories	Lag	AIC	SIC
Corporate	1	-6.790	6.62
Mutual Fund	1	-6.92	-6.74
Insurance	1	-9.75	-9.5
Pension Fund	1	-6.45	-6.36
Financial Institution	1	-6.57	-6.39

Corporate

After applying VEC model, the following equation are estimated for foreign ownership under corporate category:

$$D(\text{LEXC}) = C(1) * (\text{LEXC}(-1) - 3.16795116837 * \text{LCOR}(-1) + 30.3256675142) + C(2) * D(\text{LEXC}(-1)) + C(3) * D(\text{LCOR}(-1)) + C(4)$$

In this equation, C(1) indicates the long-term coefficient between foreign ownership under corporate category and exchange rates. More clearly, the long term relationship exists if the sign of t-statistics of C(1) is ngative and the its p-value is significant. The above equation is further estimated in order to obtained p-values. The result shows that the C(1) is -



2.66 and the p-value is 0.0091 (shown in appendix). Therefore, a long term granger causality runs from foreign corporate ownership of Indonesia financial assets to exchange rates. The following table 7 presents the results of VEC Granger causality test which is employed to investigate the short-term relationship between foreign corporate ownership and exchange rates. The null hypothesis is that a lag of independent variable does not Granger cause dependent variable. From the results, it can be seen that the foreign corporate ownership has significant p-value 0.031. Therefore, null hypothesis can be rejected at 5% level, meaning that a lag of foreign corporate ownership of Indonesia financial assets Granger causes domestic currency. On the other hand, a lag of exchange rate does not Granger cause foreign corporate ownership since the p-value 0.86 is rejected at the 5% level.

Table 7. VEC Granger Causality Between Foreign Corporate Ownership and Exchange Rates

Dependent Variable: D(EXC)			
Excluded	Chi-sq	df	Prob.
D(COR)	4.62	1	0.031
Dependent Variable: D(COR)			
Excluded	Chi-sq	df	Prob.
D(EXC)	0.02	1	0.86

Mutual Fund

The following equation are estimated for foreign ownership under mutual fund category:

$$D(LEXC) = C(1) * (LEXC(-1) - 0.678471428925 * LMF(-1) - 1.04337345559) + C(2) * D(LEXC(-1)) + C(3) * D(LMF(-1)) + C(4)$$

In this equation, C(1) indicates the long-term coefficient between foreign ownership under mutual fund category and exchange rates. More clearly, the long term relationship exists if the sign of t-statistics of C(1) is ngative and the its p-value is significant. The above equation is further estimated in order to obtained p-values. The result shows that the C(1) is -1.90 and the p-value is 0.06 (shown in appendix). Therefore, a long term granger causality



runs from foreign mutual fund ownership of Indonesia financial assets to exchange rates. The following table 8 presents the results of VEC Granger causality test which is employed to investigate the short-term relationship between foreign mutual ownership and exchange rates. The null hypothesis is that a lag of independent variable does not Granger cause dependent variable. From the results, it can be seen that the foreign mutual fund ownership has significant p-value 0.057. Therefore, null hypothesis can be rejected at 10% level, meaning that a lag of foreign mutual fund ownership of Indonesia financial assets Granger causes domestic currency. On the other hand, a lag of exchange rate does not Granger cause foreign mutual fund ownership since the p-value of 0.52 is rejected at the 5% level.

Table 8. VEC Granger Causality Between Foreign Mutual Fund Ownership and Exchange Rates

Dependent Variable: D(EXC)			
Excluded	Chi-sq	df	Prob.
D(MF)	3.59	1	0.057
Dependent Variable: D(MF)			
Excluded	Chi-sq	df	Prob.
D(EXC)	0.4	1	0.52

Insurance

The following equation are estimated for foreign ownership under insurance category:

$$D(LEXC) = C(1) * (LEXC(-1) - 4.07883946444 * LINS(-1) - 0.367569057427) + C(2) * D(LEXC(-1)) + C(3) * D(LINS(-1)) + C(4)$$

In this equation, C(1) indicates the long-term coefficient between foreign ownership under insurance category and exchange rates. More clearly, the long term relationship exists if the sign of t-statistics of C(1) is negative and the its p-value is significant. The above equation is further estimated in order to obtained p-values. The result shows that the C(1) is -2.79 and the p-value is 0.0065 (shown in appendix). Therefore, a long term granger causality runs from foreign insurance ownership of Indonesia financial assets to exchange rates. The following table 9 presents the results of VEC Granger causality test which is employed to



investigate the short-term relationship between foreign insurance ownership and exchange rates. The null hypothesis is that a lag of independent variable does not Granger cause dependent variable. From the results, it can be seen that the foreign insurance ownership has a p-value of 0.25. Therefore, null hypothesis cannot be rejected, meaning that a lag of foreign insurance ownership of Indonesia financial assets does not Granger cause domestic currency. Similarly, a lag of exchange rate does not Granger cause foreign insurance ownership since the p-value is 0.74. In other words, there is no short-term relationship between foreign insurance ownership and exchange rates.

Table 9. VEC Granger Causality Between Foreign Insurance Ownership and Exchange Rates

Dependent Variable: D(EXC)			
Excluded	Chi-sq	df	Prob.
D(INS)	1.32	1	0.25
Dependent Variable: D(INS)			
Excluded	Chi-sq	df	Prob.
D(EXC)	0.10	1	0.74

Pension Fund

The following equation are estimated for foreign ownership under pension fund category:

$$D(LEXC) = C(1) * (LEXC(-1) - 0.452157777664 * LPF(-1) - 4.35986076206) + C(2) * D(LEXC(-1)) + C(3) * D(LPF(-1)) + C(4)$$

In this equation, C(1) indicates the long-term coefficient between foreign ownership under pension fund category and exchange rates. More clearly, the long term relationship exists if the sign of t-statistics of C(1) is negative and the its p-value is significant. The above equation is further estimated in order to obtained p-values. The result shows that the C(1) is -2.46 and the p-value is 0.015 (shown in appendix). Therefore, a long term granger causality runs from foreign pension fund ownership of Indonesia financial assets to exchange rates. The following table 10 presents the results of VEC Granger causality test which is employed



to investigate the short-term relationship between foreign pension fund ownership and exchange rates. The null hypothesis is that a lag of independent variable does not Granger cause dependent variable. From the results, it can be seen that the foreign pension fund ownership has a p-value of 0.16. Therefore, null hypothesis cannot be rejected, meaning that a lag of foreign pension fund ownership of Indonesia financial assets does not Granger cause domestic currency. Similarly, a lag of exchange rate does not Granger cause foreign pension fund ownership since the p-value is 0.63. In other words, there is no short-term relationship between foreign pension fun ownership and exchange rates.

Table 10. VEC Granger Causality Between Foreign Pension Fund Ownership and Exchange Rates

Dependent Variable: D(EXC)			
Excluded	Chi-sq	df	Prob.
D(PF)	1.89	1	0.16
Dependent Variable: D(PF)			
Excluded	Chi-sq	df	Prob.
D(EXC)	0.22	1	0.63

Financial Institution

The following equation are estimated for foreign ownership under financial institution category:

$$D(LEXC) = C(1)*(\text{LEXC}(-1) - 11.1284515878*\text{LFI}(-1) + 130.899048078) + C(2)*D(LEXC(-1)) + C(3)*D(LFI(-1)) + C(4)$$

In this equation, C(1) indicates the long-term coefficient between foreign ownership under pension fund category and exchange rates. More clearly, the long term relationship exists if the sign of t-statistics of C(1) is negative and the its p-value is significant. The above equation is further estimated in order to obtained p-values. The result shows that the C(1) is -0.46, but the p-value is 0.64 (shown in appendix). Therefore, it can be inferred that there is no long run causality from foreign financial institution ownership to exchange rates. The following table 11. presents the results of VEC Granger causality test which is employed to



investigate the short-term relationship between foreign financial institution ownership and exchange rates. The null hypothesis is that a lag of independent variable does not Granger cause dependent variable. From the results, it can be seen that the foreign financial institution ownership has a p-value of 0.1063. Therefore, null hypothesis cannot be rejected, meaning that a lag of financial institution ownership of Indonesia financial assets does not Granger cause domestic currency. Similarly, a lag of exchange rate does not Granger cause foreign pension fund ownership since the p-value is 0.21. In other words, there is no short-term relationship between foreign financial institution ownership and exchange rates.

Table 11. VEC Granger Causality Between Foreign Financial Institution Ownership and Exchange Rates

Dependent Variable: D(EXC)			
Excluded	Chi-sq	df	Prob.
D(FI)	2.6	1	0.1063
Dependent Variable: D(FI)			
Excluded	Chi-sq	df	Prob.
D(EXC)	1.55	1	0.21

Vector Autoregression Granger Causality Test

Since there is no cointegrating vector in the rest of foreign ownership categories, namely individual, securities company, foundation, and other, a VAR model is applied. When employing this model, data series have to be stationary so all series that are non-stationary at level must be transformed to their first difference. From table 12, it can be seen that, for all foreign ownership categories, except other, the optimal lag length is 1. Foreign ownership under other category has an optimal lag length of 2.



Table 12. The Number of Optimal Lag Length Using AIC and SIC

Foreign Ownership Categories	Lag	AIC	SIC
Individual	1	-3.87	-3.7
Securities Company	1	-5.24	-5.07
Fondation	1	-5.8	5.62
Other	2	-6.86	-6.57

Individual

The following tabel 13 presents the results of VAR Granger causality between foreign individual ownership and exchange rates by incorporating one lag,. The null hypothesis is that one lag of a independent variable do not Granger cause a dependent variable, at 5% level. The results show that the p-value of D(IND) is statistically not significant, higher than 5% level. Therefore, the null hypothesis cannot be rejected. In other words, there is no Granger causality running from a lag of foreign individual ownership to current exchange rates, and vice versa.

Table 13. VAR Granger Causality Between Foreign Individual Ownership and Exchange Rates

Dependent Variable: D(EXC)			
Excluded	Chi-sq	df	Prob.
D(IND)	1.08	1	0.29
Dependent Variable: D(IND)			
Excluded	Chi-sq	df	Prob.
D(EXC)	0.006	1	0.93

Securities Company

The following tabel 14 presents the results of VAR Granger causality between foreign securities company ownership and exchange rates by incorporating one lag. The null hypothesis is that one lag of a independent variable do not Granger cause a dependent



variable, at 5% level. The results show that the p-value of D(SC) is statistically not significant. Therefore, the null hypothesis cannot be rejected. In other words, there is no Granger causality running from a lag of foreign securities company ownership to current exchange rates, and vice versa.

Table 14 VAR Granger Causality Between Foreign Securities Company Ownership and Exchange Rates

Dependent Variable: D(EXC)			
Excluded	Chi-sq	df	Prob.
D(SC)	0.31	1	0.57
Dependent Variable: D(SC)			
Excluded	Chi-sq	df	Prob.
D(EXC)	0.0002	1	0.98

Fondation

The following tabel 15 presents the results of VAR Granger causality between foreign fondation ownership and exchange rates by incorporating one lag. The null hypothesis is that one lag of a independent variable do not Granger cause a dependent variable, at 5% level. The results show that the p-value of D(FON) is statistically not significant. Therefore, the null hypothesis cannot be rejected. In other words, there is no Granger causality running from a lag of foreign fondation ownership to current exchange rates. Similarly, there is no Granger causality running from a lag of exchange rates to current foreign fondation ownership.

Table 15. VAR Granger Causality Between Foreign Fondation Ownership and Exchange Rates

Dependent Variable: D(EXC)			
Excluded	Chi-sq	df	Prob.
D(FON)	0.38	1	0.53
Dependent Variable: D(FON)			
Excluded	Chi-sq	df	Prob.
D(EXC)	2.43	1	0.11



Other

The following tabel 16 presents the results of VAR Granger causality between foreign ownership under other category and exchange rates by incorporating two lags. The null hypothesis is that two lags of a independent variable jointly do not Granger cause a dependent variable, at 5% level. The results show that the p-value of D(OTH) is statistically significant at 10%. Therefore, the null hypothesis can be rejected. In other words, the two lags of foreign ownership under other category jointly Granger causes current exchange rates. Conversely, two lags of exchange rates do not jointly Granger cause current foreign ownership under other category. It can be inferred that, there is a unidirectional causal relationship.

Table 16. VAR Granger Causality Between Foreign Ownership Under Other Category and Exchange Rates

Dependent Variable: D(EXC)			
Excluded	Chi-sq	df	Prob.
D(OTH)	5.73	1	0.05
Dependent Variable: D(OTH)			
Excluded	Chi-sq	df	Prob.
D(EXC)	0.74	1	0.68

CONCLUSION

The growth rate of foreign capital flows to Indonesia has increased since the country liberalized its financial system. Among other types of capital inflows, foreign portfolio investment has shown a substantial increase after 1998 when asian financial crisis occurred. The increasing amount FPI has become a concern because foreign ownership takes up the largest portion of Indonesia financial assets. This paper provides new evidence on the dynamic relationships between nominal exchange rates and foreign ownership of Indonesia financial assets, which falls under nine categories—corporate, individual, mutual fund, securities company, insurance, pension fund, financial institution, fondation, and other. Using VECM, VAR estimation, and Granger causality, the results suggest long-term relationships



between some of foreign ownership categories, namely corporate, mutual fund, insurance, and pension fund, to exchange rates. More clearly, there exist a unidirectional causality that runs from foreign corporate, mutual fund, insurance, and pension fund ownership to exchange rates in the long-run. The results also show there is a unidirectional causality that runs from foreign ownership under corporate, mutual fund, and other category to current exchange rates in the short-run. Therefore, it can be said that foreign institutional ownership, such as corporations, mutual funds, insurances, and pension funds, play a significant role in affecting the exchange rate fluctuations, in the long and short term. In sort, this study is consistent with previous studies that have found that portfolio investment affects exchange rates (Edwards, 1998; Kim and Singal, 2000; Jongwanich, 2010). This study proposes novelty in foreign capital flows and exchange rates literature by investigating a gap on the role of foreign holding composition on exchange rates fluctuations, and vice versa. In general, it is found that foreign holding of Indonesia financial assets does matter. This suggests that policy maker should pay more attention to managing foreign ownership because the reversal of inflows poses a potential danger. Another interesting avenue of research would be to deepen the analysis of the effects of foreign institutional ownership of Indonesia financial assets on exchange rates before and during GFC when rounds of QE program, which triggered capital inflows to emerging economies, were not implemented.

REFERENCES

- Barkardzhieva, Damyana, Sami Naceur, and Bassem Kamr. 2010. "The Impact of Capital and Foreign Exchange Flows on the Competitiveness of Developing Countries." *IMF working Paper* 154.
- Bird, Graham and Ramkishen S. Rajan. 2000. "Financial Crises and The Composition of International Capital Flows: Does FDI Guarantee Stability? CIES Discussion Paper No.044.
- Calvo, Guillermo A. 1998. "Capital Flows and Capital-Market Crises: The Simple Economics of Sudden Stops." *Journal of Applied Economics* 0:35-54.
- Dornbusch, R., 1980. Exchange rate economics: where do we stand? Brookings Pap. Econ. Activity 1980 (1), 143e194.



- Edwards, S. 1998. "Capital flows, real exchange rates and capital controls". NBER working paper, 6800, Cambridge MA: National Bureau of Economic Research.
- Edwards, Sebastian. 2000. "Introduction to Capital Flows and the Emerging Economies: Theory, Evidence, and Controversies." In *Capital Flows and the Emerging Economies: Theory, Evidence, and Controversies*, NBER Chapters. National Bureau of Economic Research, Inc, 1-12.
- Jongwanich, J. 2010. "Capital flows and real exchange rates in emerging Asian countries". ADB Economics Working Papers, 210.
- Kim, E. H., & Singal, V. 2000. "The fear of globalizing capital markets". *Emerging Markets Review*, 1, 183–198.
- Samo, Lucio, and Mark P. Taylor. 1999a. "Hot Money, Accounting Labels and the Permanence of Capital Flows to Developing Countries: An Empirical Investigation". *Journal of Development Economics*. Vol 59, p337-364.
- Samo, Lucio, and Mark P. Taylor. 1999b. "Moral Hazard, Asset Price Bubbles, Capital Flows, and The East Asian Crisis: The First Test". *Journal of International Money and Finance* Vol. 18: 637-657.
- Sims, Christopher. *Macroeconomic and reality*. *Econometrica* 48 (1980), 1-49.



Appendix

Dependent Variable: D(LEXC)

Method: Least Squares

Date: 04/08/17 Time: 19:38

Sample (adjusted): 2009M07 2016M12

Included observations: 90 after adjustments

$$D(LEXC) = C(1)*(LEXC(-1) - 3.16795116837*LCOR(-1) + 30.3256675142) \\ + C(2)*D(LEXC(-1)) + C(3)*D(LCOR(-1)) + C(4)$$

	Coefficient	Std. Error	t-Statistic	Prob.
C(1)	-0.003712	0.001391	-2.668774	0.0091
C(2)	-0.136320	0.106991	-1.274122	0.2061
C(3)	-0.052550	0.024426	-2.151422	0.0342
C(4)	0.004488	0.002434	1.844188	0.0686
R-squared	0.132033	Mean dependent var		0.002979
Adjusted R-squared	0.101755	S.D. dependent var		0.023424
S.E. of regression	0.022201	Akaike info criterion		-4.733968
Sum squared resid	0.042387	Schwarz criterion		-4.622865
Log likelihood	217.0285	Hannan-Quinn criter.		-4.689165
F-statistic	4.360707	Durbin-Watson stat		2.025667
Prob(F-statistic)	0.006582			

1.1. Long run relationships between foreign corporate ownership and exchange rates



Dependent Variable: D(LEXC)

Method: Least Squares

Date: 04/08/17 Time: 19:39

Sample (adjusted): 2009M07 2016M12

Included observations: 90 after adjustments

$$D(LEXC) = C(1)*(LEXC(-1) - 0.678471428925*LMF(-1) - 1.04337345559) + C(2)*D(LEXC(-1)) + C(3)*D(LMF(-1)) + C(4)$$

	Coefficient	Std. Error	t-Statistic	Prob.
C(1)	-0.008649	0.004550	-1.901022	0.0606
C(2)	-0.066211	0.104850	-0.631482	0.5294
C(3)	-0.016787	0.008850	-1.896854	0.0612
C(4)	0.004128	0.002455	1.680998	0.0964
R-squared	0.100924	Mean dependent var	0.002979	
Adjusted R-squared	0.069561	S.D. dependent var	0.023424	
S.E. of regression	0.022595	Akaike info criterion	-4.698754	
Sum squared resid	0.043906	Schwarz criterion	-4.587651	
Log likelihood	215.4439	Hannan-Quinn criter.	-4.653951	
F-statistic	3.217928	Durbin-Watson stat	2.028043	
Prob(F-statistic)	0.026724			

1.2. Long run relationships between foreign mutual fund ownership and exchange rates

Dependent Variable: D(LEXC)

Method: Least Squares

Date: 04/08/17 Time: 19:40

Sample (adjusted): 2009M07 2016M12

Included observations: 90 after adjustments



$$D(\text{LEXC}) = C(1) * (\text{LEXC}(-1) - 4.07883946444 * \text{LINS}(-1) - 0.367569057427)$$

$$+ C(2) * D(\text{LEXC}(-1)) + C(3) * D(\text{LINS}(-1)) + C(4)$$

	Coefficient	Std. Error	t-Statistic	Prob.
C(1)	-0.012419	0.004450	-2.791120	0.0065
C(2)	-0.095277	0.106388	-0.895564	0.3730
C(3)	-0.098560	0.085689	-1.150212	0.2532
C(4)	0.003904	0.002477	1.576400	0.1186
R-squared	0.100742	Mean dependent var	0.002979	
Adjusted R-squared	0.069373	S.D. dependent var	0.023424	
S.E. of regression	0.022597	Akaike info criterion	-4.698551	
Sum squared resid	0.043915	Schwarz criterion	-4.587449	
Log likelihood	215.4348	Hannan-Quinn criter.	-4.653748	
F-statistic	3.211469	Durbin-Watson stat	2.010542	
Prob(F-statistic)	0.026938			

1.3. Long run relationships between foreign insurance ownership and exchange rates

Dependent Variable: D(LEXC)

Method: Least Squares

Date: 04/08/17 Time: 19:43

Sample (adjusted): 2009M07 2016M12

Included observations: 90 after adjustments

$$D(\text{LEXC}) = C(1) * (\text{LEXC}(-1) - 0.452157777664 * \text{LPF}(-1) - 4.35986076206) +$$

$$C(2) * D(\text{LEXC}(-1)) + C(3) * D(\text{LPF}(-1)) + C(4)$$

	Coefficient	Std. Error	t-Statistic	Prob.
--	-------------	------------	-------------	-------



C(1)	-0.014650	0.005954	-2.460811	0.0159
C(2)	-0.089577	0.105586	-0.848374	0.3986
C(3)	-0.016145	0.011733	-1.376014	0.1724
C(4)	0.004136	0.002495	1.657708	0.1010

R-squared	0.103383	Mean dependent var	0.002979
Adjusted R-squared	0.072106	S.D. dependent var	0.023424
S.E. of regression	0.022564	Akaike info criterion	-4.701492
Sum squared resid	0.043786	Schwarz criterion	-4.590390
Log likelihood	215.5672	Hannan-Quinn criter.	-4.656689
F-statistic	3.305361	Durbin-Watson stat	2.014301
Prob(F-statistic)	0.023993		

1.4. Long run relationships between foreign pension fund ownership and exchange rates

Dependent Variable: D(LEXC)

Method: Least Squares

Date: 04/08/17 Time: 19:41

Sample (adjusted): 2009M07 2016M12

Included observations: 90 after adjustments

$$D(LEXC) = C(1) * (LEXC(-1) - 11.1284515878 * LFI(-1) + 130.899048078) + C(2) * D(LEXC(-1)) + C(3) * D(LFI(-1)) + C(4)$$

	Coefficient	Std. Error	t-Statistic	Prob.
C(1)	-0.000487	0.001056	-0.461534	0.6456
C(2)	-0.023880	0.106774	-0.223655	0.8236
C(3)	-0.034221	0.021188	-1.615074	0.1100



C(4)	0.003457	0.002509	1.377725	0.1719
<hr/>				
R-squared	0.031183	Mean dependent var	0.002979	
Adjusted R-squared	-0.002613	S.D. dependent var	0.023424	
S.E. of regression	0.023455	Akaike info criterion	-4.624045	
Sum squared resid	0.047312	Schwarz criterion	-4.512943	
Log likelihood	212.0820	Hannan-Quinn criter.	-4.579242	
F-statistic	0.922680	Durbin-Watson stat	1.991360	
Prob(F-statistic)	0.433447			
<hr/>				

1.1.No long run relationships between foreign financial institution ownership and exchange rates



**E-PROCUREMENT IMPLEMENTATION AND BUDGET ABSORPTION IN
INDONESIAN LOCAL GOVERNMENT**

Puji Nurhayati

Master of Accounting Student Economic And Business Faculty, Sebelas Maret University
nurhayatipuji90@gmail.com

Djuminah

Economic And Business Faculty, Sebelas Maret University
masyitahassahara@student.uns.ac.id

Masyita As Sahara

Master of Accounting Student Economic And Business Faculty, Sebelas Maret University
djuminah@gmail.com

Abstract

The information technology has been utilized widely and its utilization influences the performance level in public sector. The technology usage of goods/services procurement system electronically (e-procurement) in the government is absolutely important for achieving the acceleration of State Budget (APBN) and Regional State Budget (APBD). The acceleration of APBN and APBD implementation should be shown by the absence of buildup budget at the end of the year. This research aims at examining the influence of e-procurement technology usage toward the budget absorption. This research uses primary and secondary data. Primary data is taken from questionnaire meanwhile secondary data is taken from the Budget Realization report per trimester of East Java Province Regional Secretary. The data is collected by using 71 questionnaires which are sent to 71 Regional Working Unit (SKPD) in East Java Province. From the amount of those questionnaires, there are only 47 questionnaires can be used. The data quality test uses software SPSS 21.0 meanwhile Partial Least Square (PLS) technique with software WarpPls 5.0 is used to analyze the data. This



research result shows that e-procurement technology usage has an effect toward the budget absorption. However, e-procurement technology usage through procurement practice does not have an effect toward the budget absorption.

Keywords: *E-procurement Technology Usage, Procurement Practice, Budget Absorption.*

JEL Classification: *O57*

INTRODUCTION

Government procurement of goods/services which is efficient and effective is one of important parts in state financial management improvement. One of its embodiment is through an implementation of government procurement of goods/services electronically (e-procurement). Indonesian government has issued regulation about a mandatory of e-procurement implementation in Ministry/Institution/Local Government Working Unit/Agency (hereinafter abbreviated as K / L / D / I as stated in Presidential Regulation) as one of efforts to conduct an improvement of good state financial management.

Mandatory of e-procurement implementation in (K/L/D/I) has been defined since 2012 written in Presidential Regulation Number 70 Year 2012 which is the second amendment of Presidential Regulation Number 54 Year 2010 about Government Procurement of Goods/Services. The reason of government to establish the policy is to accelerate the implementation of goods/services. The effort conducted by government to consummate the acceleration of goods/services implementation is done through the announcement of General Draft of Goods/services Procurement (RUP) which only requires agreement of Regional Regulations Draft (Raperda) without waiting for Regional Government Budget (APBD). The policy is printed in the Presidential Regulation Number 4 Year 2015 which is the fourth amendment of Presidential Regulation Number 54 Year 2010 about Government Goods/Services Implementation.

Government sets mandatory of e-procurement obligation in K/L/D/I aiming at improving the efficiency and effectiveness of a process and procurement administration, obtaining cost reduction, and also guaranteeing the supply availability of certain types of goods/services which are urgent (bappeda.kolaka.go.id, 2016). It is in accordance with Presidential Regulation No.54 Year 2010 about Government Goods/Services Procurement stating that the implementation of e-procurement which aims at increasing accountability and



transparency, improving market access and healthy business competition, improving efficiency levels of procurement process, supporting audit and monitoring process in order to fulfill the need of information access which is 'real time'. The objectives which are about to be achieved by Indonesian Government have been perceived by countries which have already e-procurement. This is proven by researches conducted by Croom and Brandon (2005); Vaidya et al (2006); Dooley and Purchase (2006) and Quesada et al (2010) stating that the benefits of e-procurement implementation causes lower transaction cost, shorter cycle of goods/services procurement, minimum goods/services availability, higher transparency level and an increase of relationship between goods/services suppliers and users.

The benefits obtained in the e-procurement implementation are supported by the roles of advanced technology. Goodhue and Thompson (1995); Darwin (1999); Diana (2001) and Sunarta (2005) provide empirical evidence that the use of information technology can influence an individual performance. Many kinds of information technology can be used in supporting e-procurement implementation. The use of e-procurement technology is expected to influence the practice of goods/services implementation. The higher the procurement technology usage, the more procurement practice increases (Quesada et al, 2010). The procurement practices will not work if not accompanied by participation of goods/services suppliers and management support (Dooley and Purchase, 2006).

The practice of goods/services which increases more will be followed by the implementation of infrastructure building which also increases so that it will accelerate the realization of state and regional expenditures. This is in accordance with the objective of Presidential Regulation Number 70 Year 2012 about Government Goods/Services Procurement. The realization of regional and state expenditures will be achieved when the goods/services procurement can be realized immediately. Therefore, government issues Presidential Instruction Number 1 Year 2015 about Acceleration of Goods/Services Procurement and Presidential Instruction Number 1 Year 2016 about Acceleration of National Strategic Project Implementation aiming at encouraging the implementation of goods/services procurement through e-procurement so that goods/services procurement can be realized immediately. The realization of regional and state expenditures cannot be out of government control so that government establishes Evaluation and Control Team of State



Revenues and Expenditure Budget (APBN) and Regional Revenues and Expenditure Budget (APBD) (TEPRA) written in Presidential Regulation Number 20 Year 2015. It is done in order to accelerate absorption of budget and ensure that APBN and APBD are right on target in accordance with the development planning which has been issued.

The procurement practices the main factor influencing delay of budget absorption (Arif, 2012; Sukadi, 2012; Juliani and Sholihin, 2014; Astadi et al, 2015; Malahayati et al, 2015; Taufik et al, 2016). This is proven that some areas whose budgets absorbed in a long period of time year 2016 including West Java Province as Rp 8,034 billion, East Java Province as Rp 3,947 billion, Riau Province as Rp 2,867, Papua Province as Rp 2,596 billion, Central Java Province as Rp 2,596 billion, East Kalimantan Province as Rp 1,572 billion, Banten Province as Rp 1,527 billion, Bali Province as Rp 1,464 billion and Nangroe Aceh Darusalam Province as Rp 1,446 billion (Tempo, 2016).

East Java Province is the province being the second largest goods/services procurement in Indonesia in 2016 with procurement amounting to 11 905 packages and total ceiling as Rp 4.793.120 million conducted by e-procurement system (sirup.lkpp.go.id, 2016). However, in fact, the realization of budget which had been achieved by East Java province government until Quarter II Year 2016 was only 20,56%. Meanwhile, the target which has been issued by the government is 35% (Development Administration Bureau, 2017). Therefore, this research was conducted in East Java Province aiming at examining the influence of e-procurement implementation towards budget absorption in East Java Province Government. Based on the above statement, therefore, the writers wanted to conduct a research related to e-procurement implication with budget absorption in the Regional Working Unit (SKPD) East java Province Government.

THEORETICAL FRAMEWORK AND HYPOTHESIS DEVELOPMENT

Regulations and Policies of e-procurement

Regulations and policies on the implementation of goods/services e-procurement in Indonesia have undergone many changes. At the beginning, goods/services procurement was conducted conventionally. Then, it changes using electronic system. Goods/services



procurement conventionally include 2 steps namely pre-qualification and post-qualification. The selection of goods/services suppliers is decided by the Service Unit of goods/services Procurement (ULP). The procurement is still conducted by general auction where the announcement of auction and the winner will be published in the national newspaper and website of national procurement (www.pengadaannasional-bappenas.go.id). The regulation is included in the Presidential Regulation Number 80 Year 2003 about Operating Procedure of Government Goods/Services Implementation.

The General Selection of District Head is conducted simultaneously and due to Tsunami in some regions it causes the regulations of goods/services procurement experience changes for seven times. The changes are done so that the implementation of goods/services procurement can be accelerated related to logistic needs. The regulation change of goods/services procurement done by government by not changing the concept of goods/services procurement implementation so that the system of goods/services procurement is still conducted conventionally. The last changes of goods/services procurement regulations was conducted in 2007 by issuing Presidential Regulation Number 95 Year 2007 as the seven changes by Presidential Regulation Number 80 Year 2003 about Operating Procedure of Government Goods/Services Procurement Implementation. In that year, the government also established National Public Procurement Agency (LKPP) by Presidential Regulation Number 106 Year 2007 about Policy Institutes of Goods/Services procurement aiming at developing and formulating the policy of government goods/services procurement.

Along with the more advanced technology development, the government starts implementing the procurement system electronically. The purpose of changing it from conventional to electronic is in order to make the procurement conducted effectively, efficient, opened and competitive. Thus, the government issued Presidential Regulation Number 54 Year 2010 about procurement. By issuing this regulation, the government started implementing e-procurement gradually in all instances and local governments in Indonesia. The government obliged the e-procurement implementation for K/L/D/I in 2012 through Presidential Regulation Number 70 Year 2012 which aimed at accelerating the procurement process.



Even though the government has obliged the implementation of e-procurement yet there are still a few disadvantaged regions which have not yet applied it so it hampers the development acceleration and state expenditure. Therefore, the government issued Presidential Regulation Number 4 Year 2015 concerning procurement which aimed at accelerating the state expenditure by using information technology. The difference between Presidential Regulation Number 4 Year 2015 with the previous regulation is that since it was issued, the implementation of procurement must be conducted electronically through Electronic Procurement system (SPSE) which was developed by LKPP (National Public Procurement Agency). The scope of e-procurement consists of e-tendering and e-purchasing so each K/L/D/I must do e-purchasing toward goods/services which have been available in e-catalogue. The implementation of e-purchasing itself can only be conducted by PPKom (Commitment Setting Official) or official appointed by the instance leader.

The Definition of e-procurement

Presidential Regulation Number 4 Year 2015 on the fourth amendment of Presidential Regulation Number 54 Year 2010 concerning procurement states that the definition of e-procurement is the procurement of goods and services that are implemented using information technology and electronic transactions in accordance with the provisions of regulation which consists of e-purchasing and e-catalogue. Based on Australian Government Information Management (AGIMO), the definition of e-procurement is business to business purchase (business to business-B2B) and goods and services sales through internet (www.agimo.gov.au).

That definition is also supported by the research of Panayioutou (2004); Croom and Brandon (2005) and Quesada et al (2010) which state that e-procurement is the using of the integrated database system with website based through communication network system either in partly or the whole process of goods/services procurement.

E-procurement Technology Usage

The utilization of technology can be defined as the benefit which is expected by information technology users in conducting their duty measured by the usage intensity, the



usage frequency and amount of applications or software used (Thompson et al, 1991). E-procurement technology utilization and its practice which facilitates the connection electronically, information change, transactions supported by both private and public network (Quesada et al, 2010).

Goodhue and Thompson (1995); Darwin (1999); Diana (2001) and Sunarta (2005) prove that the utilization of information technology has a positive effect toward individual performance. Yet, Jurnal (2001) and Jin (2003) prove that the utilization of information technology does not have any influence toward individual performance. The same thing is also conducted by Quesada et al (2010) in his research which shows that the higher e-procurement technology usage, the higher the procurement practices so it can influence the capital expenditure budget absorption (Taufik et al, 2016).

Procurement Practice

The procurement practice of goods/services includes five stages which are started from gathering information, selecting the goods/services supplier before making goods/services procurement agreement, handing over the goods/services, and evaluating the goods/services activity (Quesada et al, 2010). That definition is almost the same with the definition stated by LKPP (Governmental National Public Procurement Agency) in the head of LKPP Regulation Number 14 Year 2015 about e-purchasing which states that procurement practice consists of Preparation Stage and Implementation Stage. Procurement practice can also include planning, programming, budgeting, selecting goods/services supplier, making procurement practices and payment agreement, the job handover, maintenance, utilization ([www. dinus.ac.id_korupsi_dalam_pengadaan_barang _ppt &usg](http://www.dinus.ac.id_korupsi_dalam_pengadaan_barang_ppt_usg)). The previous research proves that the procurement practices influences the performance of procurement practices (Quesada et al, 2010) and the absorption of capital expenditure budget (Taufik et al, 2016).

Budget Absorption

Based on Governmental Accounting Standard Statement Number 02 Year 2010, the definition of budgeting is an action principle which is going to be conducted by the government that includes the plans of income, expenditure, transfer and costing that are



measured in Rupiah and arranged based on certain classification systematically for one period. Mardiasmo (2005) defines the budget absorption as an image of local government ability in conducting and accounting for each activity that has been planned. The absorption of the local government budget is the accumulation of budget absorption conducted by SKPD. SKPD budget absorption is the unit budget proportion that has been released or realized in one budgeting year (Malahayati et al, 2015) and stated in percentage form (Taufik et al, 2016). The budget absorption is a measurement which states how far the planning target has been achieved by an governmental office (Kuncoro, 2013 in Taufik et al, 2016).

Based on the research results above, the hypothesis which can be tested in this research are as follow:

H1: e-procurement technology usage has effect toward budget absorption.

H2: e-procurement technology usage has effect toward budget absorption through the procurement practices.

RESEARCH METHOD

Research Model

This research is conducted by SKPD in East Java Province. The population in this research is SKPD which has applied e-procurement in conducting goods/services procurement and obtained PPKom. The sample consists of 71 respondents which confirmed to 71 SKPD. The source of data used are the primary and the secondary data.

The primary data are collected from the by using Likert scale of 6 (six) alternatives, such as Never (1), Rarely (2), Fair (3), Often (4), Always (5), and Not Know (6). The secondary data uses Budget Realization Report per quarter of the year 2016 which is obtained from Development Administration Bureau of East Java Province regional secretary. This research examines the influence of e-procurement technology usage toward budget absorption in SKPD level of East Java Province. The variable indicator used in this research is taken from the research of Quesada et al (2010) and Taufik et al (2016).



Analysis Model

This research uses line analysis model, that is the usage of regression analysis to estimate the causality relationship between variables (causal model) that has been set up previously based on theories (Lind, 2014). The research is conducted in purpose to explain the direct influence of e-procurement technology usage toward the budget absorption and the effect of e-procurement technology usage toward the budget absorption through Procurement Practice.

Data Quality test is done by using validity test and reliability of a set of questionnaire used. Rule of Thumb that is used for validity test is $<0,05$ significant value, while the data is considered reliable if it has $>0,70$ Composite Reliability value and $>0,60$ Cronbach's Alpha (Hair et al, 1998). The descriptive statistic and the data quality testings use software SPSS 21.0. Further, the hypothesis is tested by using two substructure model through software WarpPls 5.0. The first substructure model calculates path coefficient of e-procurement technology usage toward the budget absorption. The second substructure model determines path coefficient of e-procurement technology usage toward the budget absorption through procurement practice.

Operational Definition and Variable Measurement.

E-procurement Technology Usage

E-procurement technology usage is defined as technology network usage which its practice facilitated through connection electronically, information change and transaction supported through private and other public connection (Quesada et al, 2010). E-procurement technology usage shows how far the benefit obtained by technology users measured through application usage intensity and software used.



Table 1. Variable Measurement of E-procurement Technology Usage

No	Indicator
1	Internet
2	Intranet
3	Electronic Data Interchange (EDI)
4	Email
5	e-Catalogue
6	Electronic File Transforming (EFT)
7	Video Conference
8	Electronic Markets (website: LPSE)
9	e-Tendering

Source: Quesada et al. (2010)

Procurement Practice

Procurement practice includes planning, programming, budgeting, selecting goods/services supplier, implementation of procurement practices agreement and payment, job handover, maintenance and utilization (www.dinus.ac.id_korupsi_dalam_pengadaan_barang_ppt & usg). That procurement practice itself is a process of conducting procurement practices which includes gathering information, selecting goods/services supplier, agreement of goods/services procurement, goods/services handover and evaluation of goods/services procurement activity.

Table 2. Variable Measurement of Procurement Practice

No	Dimension and Indicator
1	Gathering Information
	Finding goods/services supplier to make agreement of goods/services procurement.
	Finding conformity of goods/services that are going to be ordered.
	Consulting about the quality of goods/services
	Finding requirement information about its service follow-up, installation, maintenance and goods/services guarantee.



2	Selecting goods/services supplier (before goods/services)
	Request of document goods/services offer to goods/services supplier.
	Request of goods/services Proposal to goods/services supplier.
	Request of goods/service information to goods/services supplier.
3	Goods/services procurement agreement (negotiation and fulfillment)
	Doing negotiation and fulfillment of goods/services price.
	Doing negotiation and fulfillment of goods/services standard (specification).
	Doing negotiation and fulfillment of the possibility goods/services conformity
	Doing negotiation and fulfillment of goods/services shipping schedule.
	Doing negotiation and fulfillment of the amount of goods/services shipping.
	Doing negotiation and fulfillment of goods/services procurement agreement.
4	Goods/services handover (negotiation)
	Doing negotiation of reception over goods/services submitted.
	Doing negotiation of place over goods/services handover.
	Doing negotiation of goods/services supplier facture making.
	Doing negotiation of goods/services payment.
5	Evaluation of goods/services procurement activity
	Finding information about goods/services order.
	Finding information about goods/services shipping.
	Finding information about goods/services specification and goods/services shipping delay.
	Finding information about goods/services supplier performance.
	Finding information about goods/services procurement history.
	Finding information about goods/services procurement performance.

Source: Quesada et al (2010)

Budget Absorption

Mardiasmo (2005) defines budget absorption as the image of local government ability in conducting and accounting for every activity that has been planned. The budget absorption of SKPD is a unit budget proportion which has been released or implemented in one budget



year (Malahayati et al, 2015) and stated in percentage form (Taufik et al, 2016). The measurement of budget absorption in this research uses the amount of budget realization percentage from trimester I to IV in 2016 which taken from budget realization report of Development Administration Bureau of East Java Province Regional Secretary.

DISCUSSION RESULT

Pilot Test

The pilot test is conducted in Bina Marga Public Work Department of East Java Province. The purpose of this pilot test is to examine the validity and construct reliability by using software SPSS 21.0. The parameter that is used to examine the validity is significance value $<0,50$ (Hair et al, 1998). A construct is called reliable if the value of Composite Reliability is $>0,70$ and Cronbach's Alpha is $>0,60$ (Hair et al, 1998). Based on rule of thumb, the analysis result of the pilot test shows that validity test and reliable are fulfilled. From 32 variable indicators of e-procurement technology usage and procurement practice, there is only 1 invalid indicator. That invalid indicator has been omitted and the valid instrument can be tested further in the field.

Descriptive Statistic

Table 3. Descriptive Statistic

Information	N	Minimal	Maximal	Mean	Deviation Standard
e-procurement Technology Usage	47	1,44	5,33	3,0047	0,76208
Procurement Practice	47	2,77	5,23	4,1944	0,70359
Budget Absorption	47	77,00	98,00	93,5319	3,49441

Source: Data Processing Output SPSS 21.0



Based on the descriptive statistic, it can be concluded that minimal value of e-procurement technology usage is 1,44 and procurement practice is 2,77 which mean that several SKPD in East Java Province rarely utilize e-procurement technology and fairly implement procurement practice.

The Minimal value of budget absorption is 77,00 which means the budget absorption of SKPD in the end of 2016 is at least 77%. The maximal value of e-procurement technology usage is 5,33 and procurement practice is 5,23 which mean the intensity level of SKPD in e-procurement technology usage and Procurement Practice is at the highest value. The maximal value of budget absorption is 98,00 which means SKPD budget absorption in the end of 2016 is up to 98%.

The mean value of e-procurement technology usage (3,0047) is lower than its value of procurement practice (4,1944). It shows that SKPD tends to more emphasize on implementing procurement practice more e-procurement technology usage. The average value of budget absorption is 93,5319, it means that through e-procurement technology usage and procurement practice, the average budget absorption of SKPD in 2016 is 93,53%. Deviation standard value of e-procurement technology usage is 0,76208, procurement practice is 0,70359 and budget absorption is 3,4944, it means data variance is relatively small since the deviation standard is smaller than the mean value. The condition in which e-procurement technology usage data is the most diverse (heterogeneous) with a value of coefficient of variation of 25.36% followed by goods / services procurement practice which is quite heterogeneous (coefficient of variation of 16.77%) and the most homogeneous data is the budget absorption with coefficient of variation of 3.66%.



Correlation test

Table 4. Correlation Test

Variable	Correlation between construct			P Values		
	e-Procurement Technology Usage	Procurement Practice	Budget Absorption	e-Procurement Technology Usage	Procurement Practice	Budget Absorption
e-Procurement Technology Usage	(0,738)	-0,102	0,054	(1,000)	0,493	0,717
Procurement Practice	-0,102	(0,711)	0,016	0,493	(1,000)	0,916
Budget Absorption	0,054	0,016	(0,821)	0,717	0,916	(1,000)
Total	47					

Source: Processing data Output WarpPls 5.0

Matrices of correlation between construct at table 4 show that there is a positive relation which is fairly strong and significant among variables from one to another. The correlation coefficient of e-procurement technology usage toward procurement practice is 0,738, e-procurement technology usage toward budget absorption is 0,711 and procurement practice toward budget absorption is 0,821. That positive relation can be interpreted that if e-procurement technology usage increases, budget absorption could be predicted to be increase as well through Procurement Practice.

It also shows that there is an early indicator of support toward mediation hypothesis because mediation hypothesis requires a significant correlation between independent and



dependent variable through intervening variable. A variable is said having a correlation with another variable if the diagonal value of correlation test result with the latent variable is higher than the value above/below in the same column, or that diagonal value is higher than the value on the left/right side in the same line (Kock, 2015).

Hypothesis Test

Path analysis

Path analysis model in this research aims at examining the effect of e-procurement technology usage toward budget absorption and e-procurement technology usage toward budget absorption through procurement practice in East Java Province. The following descriptions are the result of path analysis test:

Table 5. Path Coefficients Test and P Values

	Path Coefficients	P Values	Effect sizes	Error Standard
ETU → PP	-0,233	0,043	0,054	0,133
PP → BA	0,136	0,164	0,010	0,138
ETU → BA	0,243	0,036	0,050	0,132

Source: data processing output WarpPls 5.0

Based on table 5 above, it shows that e-procurement technology usage on goods/services procurement practice has a path coefficient value of -0,233 and p-value of 0,043 (<significant at 0,05). It means e-procurement technology usage has a negative significant effect on goods/services procurement practice. Goods/services procurement practice on the budget absorption has a path coefficient value of 0,136 and p-value of ,164 (> significancy 0,05).

It can be defined that goods/services procurement practice has no significant effect on the budget absorption. E-procurement technology usage on the budget absorption has coefficient value of 0,243 and p-value of 0,036 (<significancy 0,05). It indicates that e-procurement technology usage has a positive significant effect on the budget absorption.



Hypothesis 1 Examination: E-procurement Technology Usage Has an Effect on the Budget Absorption.

Hypothesis 1 shows that e-procurement technology usage has an effect on the budget absorption. Table 5 shows that there is an effect of e-procurement technology usage on the budget absorption (p-value of 0,036 with path coefficient of 0,243). This conclusion implies that if e-procurement technology usage increases, the budget absorption will also increase. The higher intensity level of e-procurement technology usage conducted by SKPD of East Java Provincial Government, the budget absorption of SKPD will also increase. This conclusion supports the researches of Goodhue and Thompson (1995); Darwin (1999); Diana (2001) and Sunarta (2005), which prove that information technology usage has a positive effect on the individual's performance. The results are also supported by research of Taufik et al (2016) which states e-procurement has an effect on the budget absorption. However, the conclusion of this study is different from the result of researchers Jurnal (2001) and Jin (2003) which states that information technology usage does not affect the individual's performance.

Hypothesis 2 Examination: E-procurement Technology Usage Has an Effect on the Budget Absorption through Goods/Services Procurement Practice

Hypothesis 2 states that e-procurement technology usage has an effect on the budget absorption through goods / services procurement practice. Table 5 shows that there is no effect of e-procurement technology usage on the budget absorption through goods/services procurement practice (p-value 0.043 and 0.164 with a path coefficient of -0.032 which is derived from the multiplication between -0.233 and 0.136).

The conclusion explains that e-procurement technology usage has no effect on the budget absorption through goods/services procurement practice. Thus it can be interpreted that goods / services procurement practice cannot mediate the relationship between e-procurement technology usage and the budget absorption. This means that if e-procurement technology usage conducted by SKPD East Java Province increases, the budget absorption obtained by SKPD will not increase through goods/ services procurement practice. This conclusion is different from the research of Taufik et al (2016) which states that



goods/services procurement practice has an effect on the budget absorption. The reason goods / services procurement practice cannot mediate the relationship between e-procurement technology usage and the budget absorption is assumed because SKPD rarely does an evaluation of the completed goods/services procurement practice. It is proven by the response "rarely" given by SKPD in answering questions of questionnaire related to the information searching to evaluate goods / services procurement practices that have been completed. SKPD's response is in accordance with the Regulation of the LKPP No. 14 in 2015 about e-purchasing which revealed that LKPP as a party which monitors and evaluates goods / services procurement practice. Monitoring and evaluation results will be used by the head of LKPP or head region/ Officer appointed by the head region for material analysis in following up the contract. Therefore, PPKom does not have an authority to evaluate goods / services procurement practice done by SKPD. As there is no evaluation of goods/services procurement practice is assumed causes goods/services procurement practice is not able to mediate the relationship between e-procurement technology usage and the budget absorption.

CONCLUSION AND LIMITATION

Conclusion

Based on discussion result that has been conducted, eventually it can conclude that e-procurement technology usage has effect toward budget absorption while e-procurement technology usage through procurement practice does not have effect toward budget absorption. Based on the result, it can be interpreted that if e-procurement technology usage increases, budget absorption also increases. Yet, if e-procurement technology usage increases through procurement practice, budget absorption does not increase. Analysis result and conclusion in this research are matched to some previous research results which state that e-procurement technology usage has effect toward procurement practice (Quesada et al, 2010) and information technology utilization has effect toward individual performance (Goodhue and Thompson, 1995; Darwin, 1999; Diana, 2001; Sunarta, 2005). However, this research find is contradictory result with Jurnal (2001) and Jin (2003) which state that information technology utilization does not have effect toward individual performance and goods/services



procurement practice influences the capital expenditure budget absorption (Taufik et al, 2016).

Limitation

Based on the previous research results that have been conducted, the writer identified some limitations in this research as follow:

1. 55 (fifty-five) questionnaires sent directly to each SKPD, while the remaining amount of 16 (sixteen) questionnaires mailed by reason of mileage.
2. 22.5% (twenty-two point five percent) of the respondents who were mailed did not give a response.
3. From each SKPD, researchers involves only one (1) respondent by providing one questionnaire.

Suggestion

For researchers with a similar topic could do the following:

1. To increase response rate, questionnaires should be given directly by researchers. This shows the seriousness of the researcher on the attention that will be given by the respondents.
2. To obtain the facts of this observation variable respondents from each SKPD should consist of those who are concerned about the implementation of the e-procurement so the obtained scores will show the fact not a perception.
3. Scope This research can be expanded with a different region e.g. Jakarta Province so that the analysis of the e-procurement can be done more comprehensively through comparative analysis.
4. For further research, performance goods / services variables can be added, because the ultimate goal of goods / services procurement through e-procurement can improve the performance of SKPD.



REFERENCES

- Arif, E. (2012), "Identifikasi Faktor-Faktor Penyebab Minimnya Penyerapan Anggaran Pendapatan dan Belanja Daerah (APBD) Kabupaten/Kota Di Provinsi Riau Tahun 2011", *Jurnal Ekonomi, Manajemen dan Akuntansi I* Vol 19 No. 2 Desember 2012
- Astadi N.G, Sutarja, IN, Nadiasa, M.(2015), " Analisis Sistem Pengadaan Proyek Konstruksi Terhadap Penyerapan Anggaran Pemerintah Kabupaten Badung", *Jurnal Spektran* Vo. 3 No. 1 Januari 2015
- Croom, S.R. & Alistair. Jones, B. (2005), "Key Issues In E-Procurement Implementation and Operation In Public Sector", *Journal of Public Procurement*, Vol 5, Issue 3, 367-387
- Baron, R.M., & Kenny, D.A. (1986), "The moderator-mediator variable distinction in social psychological research: Conceptual, strategic and statistical consideration", *Journal of personality & Social Psychology*, 51 (6), 1173-1182
- Croom, S.R. & Alistair. Jones, B. (2005), "Key Issues In E-Procurement Implementation and Operation In Public Sector", *Journal of Public Procurement*, Vol 5, Issue 3, 367-387
- Darwin,R.,N.,(1999), "Komputerisasi Pasar Swalayan: Implikasi Terhadap Kinerja Karyawan", Tesis Program Pascasarjana Magister Manajemen: Universitas Diponegoro.
- Development Administration Bureau (2017), Laporan Realisasi Anggaran. Sekretaris Daerah Provinsi Jawa Timur
- Diana, P., Medah. (2001), "Studi Empiris Tentang Faktor-Faktor Yang Mempengaruhi Pemanfaatan Personal Computing Dan Dampaknya Terhadap Kinerja Karyawan Akuntansi", Tesis Magister Sains Akuntansi: Universitas Diponegoro.
- Dooley, K. & Sharon, P. (2006), "Factors Influencing E-Procurement Usage", *Journal of Public Procurement*, Vol 6, Issues 1 & 3, 28-45
- Goodhue, Dale L. & Thompson , Ronald L. (1995), Task Technology Fit and Individual Performance. *MIS Quarterly*, June p. 6-15.
- Hair, J.F., Anderson, R.E., Tatham, R.L., & Black, W.C.(1998), *Multivariate Analysis*. 5th ed. Prentice Hall International, Inc.
- <http://bappeda.kolaka.go.id> accessed on 07 October 2016 at 20.17 WIB



- <https://www.agimo.gov.au/publication/2001/11/ar00-01/glossary> accessed on 13 November 2016 at 21.30
- https://www.google.co.id/dinus.ac.id._korupsi_dlm_pengadaan_barang_.ppt&usg accessed on 01 December 2016 at 13.05.
- <https://sirup.lkpp.go.id/sirup/application/index> accessed on 01 December 2016 at 13.15
- <https://m.tempo.co/read/news/2016/08/05/087793615/sri-mulyani-publikasi-serapan-anggaran-tak-sudutkan-daerah> accessed on 13 November 2016 at 21.07
- Juliani, D & Sholihin M. (2014), “Pengaruh Faktor-Faktor Kontekstual Terhadap Persepsian Penyerapan Anggaran Terkait Pengadaan Barang/Jasa”, *Jurnal Akuntansi dan Keuangan Indonesia* Vo. 11 No. 2, Desember 2014
- Junali, T.,(2001), “Analisis Pengaruh Faktor Kesesuaian Tugas Teknologi Dan Pemanfaatan Teknologi Informasi Terhadap Akuntan Publik”, *Simposium Nasional Akuntansi IV*.
- Kock, N. (2015), *WarpPLS 5.0 User Manual*. Penerbit: Script Warp System. Texas USA.
- Lind, Marchal & Wathen. (2014), *Teknik-Teknik Statistika Dalam Bisnis dan Ekonomi*. Penerbit: Salemba Empat. Jakarta
- Malahayati, C. Islahudin, Basri, H. (2015), “Pengaruh Kapasitas Sumber Daya Manusia, Perencanaan Anggaran dan Pelaksanaan Anggaran Terhadap Serapan Anggaran Satuan Kerja Perangkat Daerah (SKPD) Pada Pemerintah Kota Banda Aceh”, *Jurnal Magister Akuntansi Pascasarjana Universitas Syiah Kuala* ISSN 2302-0199 pp. 11-19.
- Mardiasmo. (2005), *Akuntansi Sektor Publik*, Penerbit: Andi Yogyakarta.
- Panayiotou, N.A, Sotiris P., Gayialis P. Tatsiopoulos. (2004), “An. E-Procurement System For Governmental Purchasing”, *International Journal Economics* 90 79-120
- Quesada G., Gonzalez, Marvin E., Mueller, J., Mueller, R. (2010), ”Impact of e-procurement on procurement practice and performance”, *Benchmarking: An International Journal*, Vol. 17 Iss 4 pp. 516-538
- Republik Indonesia. Instruksi Presiden No. 1 Tahun 2015 tentang Percepatan Pelaksanaan Pengadaan Barang/Jasa Pemerintah.
- Republik Indonesia. Instruksi Presiden No. 1 Tahun 2016 tentang Percepatan Pelaksanaan Proyek Strategis Nasional.



- Republik Indonesia. Keputusan Presiden Nomor 80 tahun 2003 tentang Pedoman Pelaksanaan Pengadaan Barang/Jasa Pemerintah.
- Republik Indonesia. Keputusan Presiden No. 20 Tahun 2015 tentang Tim Evaluasi dan Pengawasan Realisasi Anggaran Pendapatan dan Belanja Negara (APBN) dan Anggaran Pendapatan dan Belanja Daerah (APBD)
- Republik Indonesia. Peraturan Pemerintah No. 71 Tahun 2010 tentang Standar Akuntansi Pemerintahan.
- Republik Indonesia. Peraturan Presiden Nomor 95 Tahun 2007 Sebagai Perubahan Ketujuh Atas Keputusan Presiden Nomor 80 Tahun 2003 Tentang Pedoman Pelaksanaan Pengadaan Barang/Jasa Pemerintah.
- Republik Indonesia. Peraturan Presiden Nomor 106 Tahun 2007 tentang Lembaga Kebijakan Pengadaan Barang/Jasa Pemerintah (LKPP).
- Republik Indonesia. Peraturan Presiden Nomor 54 Tahun 2010 tentang Pengadaan Barang/Jasa Pemerintah.
- Republik Indonesia. Peraturan Presiden Nomor 70 Tahun 2012 Tentang Perubahan Kedua Peraturan Presiden Nomor 54 tahun 2010 tentang Pengadaan Barang dan Jasa Pemerintah.
- Republik Indonesia. Peraturan Presiden Nomor 4 Tahun 2015 Tentang Perubahan Keempat Peraturan Presiden Nomor 54 tahun 2010 tentang Pengadaan Barang dan Jasa Pemerintah.
- Sunarta, I., N. (2005). “Analisis Faktor-Faktor Yang Mempengaruhi Pemanfaatan Teknologi Informasi Dan Pengaruh Pemanfaatan Teknologi Informasi Terhadap Kinerja Individual”. Tesis Magister Sains Akuntansi: Universitas Diponegoro.
- Taufik, M., Darwanis, Fahlevi, H., (2016), “Pengaruh Penerapan e-Procurement dan Kompetensi Pejabat Pembuat Komitmen Terhadap Pelaksanaan Pengadaan Barang dan Jasa Dan Implikasinya Terhadap Penyerapan Belanja Modal (Studi Pada Satuan Kerja Lingkup Pembayaran Kantor Pelayanan Perbendaharaan Negara Banda Aceh)”, Jurnal Magister Akuntansi Pascasarjana Universitas Syiah Kuala.



- Thompson, Ronald L., Higgins, Christopher A, dan Howell, Jane, M. (1991), "Personal Computing: Toward a Conceptual Model of Utilization", *MS Quarterly*, March, pp.125-143
- Vaidya, Kishor, Sajeev, A.S.M, Callender, Guy.,(2006), "Critical Factors That Influence E-procurement Implementation Success In The Sector Public", *Journal of Public Procurement Vol 6 Issues 1 & 3*, 70-99



**ORGANIZATIONAL LEARNING AS INTERVENING VARIABLE ON
ASSOCIATION OF IT COMPETENCE TO PERFORMANCE OF PUBLIC SECTOR
ENTITIES: AN EMPIRICAL STUDY AT SIMDA OF BOGOR LOCAL
GOVERNMENT**

Marsdenia

Universitas Indonesia

idelid53@gmail.com

Abstract

The purpose of this study is to analyze the effect of Organizational Learnings as intervening variable of IT Competency effect to Bogor Local Government performance. This study uses survey method by distributing questionnaires to staff which in doing her/his job related to SIMDA as unit analysis in preparing LKPD (Local Government Financial Report). Processing of data collected will use Structural Equation Modelling (SEM). This Research finds variable Organizational Learning will play significant role in mediating the effect of IT competence on Bogor Local Government Performance.

Keywords: Organizational Learnings, IT Competency, Local Governance, Governmental

JEL Classification: D23, R50, H83

INTRODUCTION

This study based on journal by Tippin and Sohi (2003) as a major journal reference. This study has aimed to analyze the effect of Organizational Learnings as intervening variable of IT Competency effect to Bogor Local Government performance. This study uses survey method by distributing questionnaires to staff which in doing her/his job related to SIMDA as unit analysis in preparing LKPD (Local Government Financial Report). Processing of data collected will use Structural Equation Modelling (SEM). Sample of the research consists of 271 managers from various manufacturing companies, and have concluded variable *organizational learning* was crucial role as mediating variable on effect of IT competence to organization performance. So far, there are very limited research focused



on this topic which applied to public sector entity, especially in the governmental institutions. In the era of local government autonomy, the function of local government in manage their people have increasing drastically. On the other side, local government should report using and spend of budgeting periodically as tools of accountability. Through regulation of Permendagri No. 8 tahun 2009, the central government will evaluate local government performance yearly and the output of such evaluation is score of EKPPD for each local government. Preparation of EKPPD referred to LKPPD (Laporan Penyelenggaraan Pemerintahan Daerah (LPPD)).

This research try to developed study by Pippin and Sohi (2003) and have objective to explore effect of variable organizational learning as variable intervening on association of IT competence to public sector entity performance, at local government of Bogor, West Java. This research try to investigate whether intervening variable have important role to mediate association of IT Competence at Bogor Local Government to Local Governmental of Bogor City by using new tool of measurement EKPPD.

Contribution of research consists of two things, they are first, this research expected will give the alternative proxy to measure performance of government institutions (UU No. 8 year 2009). There are some differences between research of and Sohi (2003) and this study, as unit analysis of the research are direct staff level involved with compiling financial statements by using IT software at the Local Government of Bogor City. IT Software of Local Government of Bogor City is SIMDA which prepared by BPKP.

The second difference is that this study focused on Organizational Learning variable at local governmental with customer is people of Bogor City, DPRD and central governmental. Research of Pippin and Sohi (2003) used managers as research unit analysis in the manufacturing company and the costumers are buyer of manufacturing products. On the next paragraph we will discussed theoretical framework, research method and questionnaires as attachments.



LITERATURE REVIEW AND HYPOTHESES DEVELOPMENT

Information Technology and Organizational Strategy

Before 1990, majority literatures focused on importance of information technology and the opportunity of information technology as an alternative for the whole of range for strategy variable and industrial structure, including cost positions, economic scale, and bargaining position (Cash and Kosyuski, 1985; Porter, 1985; Clemons, 1986). In contrast to period after 1990, literature more focused on association between IT and specific component of organizational strategy, such as scanning on environmental component (Maier et al, 1997), competitive advantage component (Mata et al, 1995), organizational performance component (Dollinger, 1984, Powell and Dent-Micallef, 1997; Bharadwaj, 2000) and also accumulated knowledge component (Bettis and Hitt, 1995; Grant, 1996).

Next, Resource-based view concept (RBV) have been developed in IT field, that have meaning that changes in the companies those have will compete on the human resources basis that distributed heterogeneously inter company (Barney, 1991), heterogeneously resources are responsibility of the variance which come from observation of financial performance inter company (Peteraf, 1993). It is difference with perspective on external focused based, which find out a bounding a company strategy on competitive position, RBV perspective focused on internal organization resources competitiveness.

IT Competence

According to RBV perspectives, competence cannot imitized, consequently, this condition have an effect on competitive advantages of company (Lei et al., 1996). So, the company has a possibility to reached high level IT competence and logically, will be in the superior position in managing “*invisible assets*” which used to create company in the position of prominent in the market (Itami, 1987). Conceptualization of IT competence as extension of organization knowledge about and utilization effectively of IT in managing all of the information in the organizations.

Assumptions of conceptualization are each organization owned IT object (such as: *software, hardware, IT personnel*). Cumulatively, there are 3 (three) dimensions of IT



Competence describes co-specializations resources that provides indications those organizations have ability to understand and utilize IT tools and processing everything needed to manage market and customer information. Components of each IT competence, i.e. IT knowledge, IT operations and will be explained in details.

IT Knowledge

IT knowledge is a combination of information and experience, context and interpretations and reflection (Davenport, De Long, and Beers, 1998; 43). According to Capon and Glazer (1987) *IT knowledge* cannot differentiate as subset of more general concept than knowledge. Technical knowledge is a groups of principles and techniques which used to explained any change agreed to expected final outcome (Taylor, 1971).

IT Operations

Technical Operations, or techniques, consists of activities that carried out in order to achieved ultimate goal (Mitcham and Mackey, 1983). IT operations is methods, skills, and process needed to complete tasks (Granstrand, 1982). Technical operations meanings as manifestations of technical knowledge such as implementations of technical knowledge output of technical operations or skills. Conceptualizations of IT operations as extension of organizations IT utilizations to manage market and customer information.

IT Object

According to Glazer (1991) *IT Objects* have roles and responsibility to elevate production information and information dissemination. For this research IT objects conceptualizations describes computer based hardware, *software* and human resources supports.

Organizational Learning

According to Slater and Narver (1995) at the basic level of organizational learning is processing about new knowledge or mindsets developed by company, organizational learning



consists of 4 (four) components, are information gathered/obtained, information dissemination, and information sharing.

Information Obtained/Gathered

Information gathered components are an actively process of company to obtained and collected benefit information (Slater and Narver, 1995). Component process to obtained information consists of : organizations obtained information through direct experience, from other party experience, or from company's experience which have memorized mechanism, that mechanism in this context as if warehouse of information at the company.

Information Disseminations

According to Maltz and Kohli (1996); Slater and Narver (1995), information dissemination components is an extension of information obtained from organization that shares among functional units, through formal path and informal path. Information disseminations provides competitiveness as a different perspectives and in the form of thought sharing.

Interpretation Sharing

Slater and Narver (1995) have an understandings that interpretations sharing components as actualizations of consensus among organization members related to understandings of information. If disseminations of Information through company, so consensus of company should be done, and should be thought how information understandings have an impact on organization strategy in the future. Next, interpretations sharing components are playing a role in obtaining information and future interpretations (Slater and Narver, 1995).

Organization Memorized

Memorized refer to quantity of information or company experienced about specific phenomena (Moorman and Miner, 1997). Memorized play 2 (two) primary role of *organizational learning*, those are: first, memorized provides basic for changing through



generation learning process (generative learning process), and second memorized have significant influence through learning process through impact on the types of information and a way how to analyzed those information (Slater and Narver, 1995).

Local Government and Software SIMDA

To measure Local Government Bogor city performance, we used score of EKPPD (skor Evaluasi Kinerja Penyelenggaraan Pemerintah Daerah) published by Ministry of Internal affair by year. Measurement of EKPPD is using data provided in the LKPD (Laporan Kinerja Pemerintahan Daerah).

Information system used by Local Government Bogor city in order to prepared LKPD, provided by *software* SIMDA products of BPKP. Starting from 2015 financial statement preparation based on accrual basis, and this research will caught up this moment. Research prediction is through *intervening organizational learning* variable expected will increase Local Government Bogor city performance.



Hypotheses Building/ Development

Based on introduction on the earlier of this paper, and literature review, we proposed research model as followings : (picture 1)

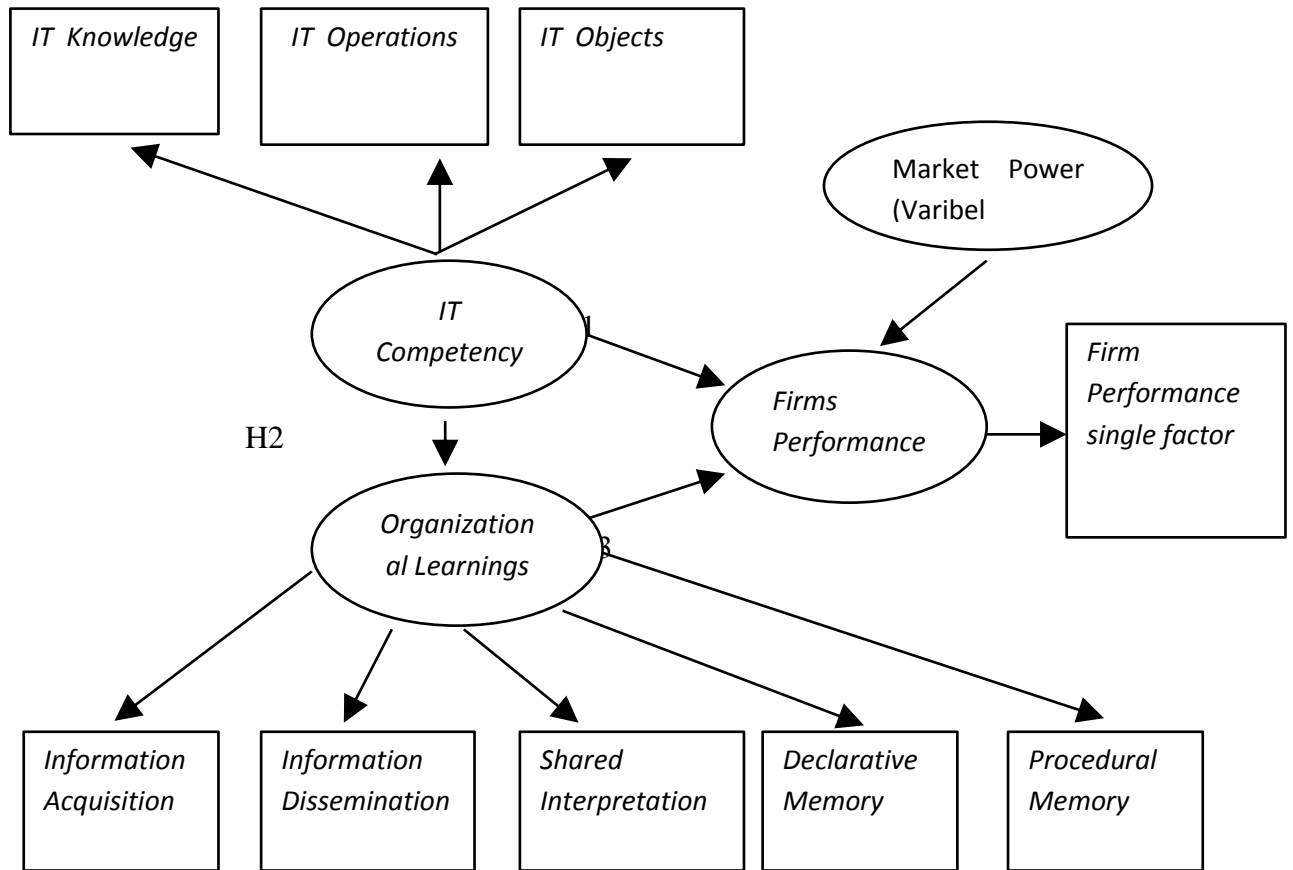

Figure 1. Conceptual Framework

(Source: Tippins and Sohi, 2003)

Before explaining picture 1, there are some conditions we should noted: Competence and organizational learning as 2nd order, and to decrease clutter, only two indicants showed by 1st order factor. Meanwhile, control variable is market power which consists of reactive organization size components rekatif and market share.

Picture 1, describes research model and on that model, conceptualization of IT Competence as higher order construct which consists of 3 domains which presented through ist order: *IT knowledge, IT Operations and IT Objects*. The same with conceptualizations of

which presented through 1st factor order: *information acquisition, Information dissemination, shared interpretations, declarative memory and procedural memory.*

In the research model we know the research focus: IT Competence influence organizations performance and mediating variable of organizational learning. So, we developed 3 (three) Hypotheses as follows

1. Association between IT Competence and Organization performance
2. Association between IT Competence and *organizational learning*
3. Association of *organizational learning* to organizational performance

IT Competence and Organization Performance: A partial mediating case

Bharadwaj (2000) have so many debates on IT Capability that have an ability to shifted obstacle cross company, strong case will make the capability inefficient in providing sustainability of competitive advantages positions due to, easiest to imitized new technology. Consistent with Clemon and Row (1991), benefit resulted from innovative applications of IT more persistent if its system used the uniqueness of resources of innovative organizations, so competitor could not raise any benefits due to duplications or imitations of new IT. For this conditions IT impact to influenced of IT on organization performance could not know directly, but we will know by quantified checking indirect impact on some intervening variable of organization capability, such as organizational learning.

Lucas (1999), concluded that some companies could get some positive benefits, contrast, other company could get productivity paradox, it means the company received negative return from IT investments, so we concluded that organizations could not get increasing in performance, and finally we should make an integration in the organizations in order to produced positive impacts. Based on that arguments, we proposed the following hypotheses:

H₁: Organizational Learning variable as Mediating effect on Associations of IT Competence and organization performance



IT Competence and Organizational Learning

According to Hope and Hope (1987), IT provided the member or staff in the organization a fast access and effective in the amount of information and IT could ensure that each of organization staff got recent and relevant market information, through acceleration in obtaining information and information disseminations of those organizations. So, we expected the company developed IT Competence that have opportunity to increase ability in obtaining information and disseminating an information to staff or other department within an organization.

IT provided needed mechanism to save information, in order saved information would give benefits, so staff of an organization could access information and interpreted those information in the same way, then as part of company's basic knowledge as a whole. In the future, those staffs expected could synthesized those informatios to be new information on the basis of combined information plus an information access in the saved information. Based on previous paragraphs, we proposed 2nd hypotheses as follows

H₂: IT Competence have positive association with organizational learning

Organizational learning and Organizational Performance

Learning organization better translate as organizational strategy in facing the customer and the competitor, and expected in the future will elevate the company profit (Slater and Narver, 1995). Besides profit, as tool to measure organizational performance, we can use sales growth got from learning process.

We can related customer retention organizational learning, due to the meaning of customer retention is customer persistence to return to the company or organizations in order to received service and or product of those organizations. Consistent with Slater and Narver (1995), since organization have an ability in the proper way to learn and to know customer demands and needs will provide higher level of customer satisfaction, and connected to customer retention.

One of the form of local governmental accountability is legally published or issued regulation of PP No. 3/2007 about LPPD. LPPD issued every year based on RKPD (Rencana kegiatan Pemerintahan Daerah) to central, LPPD can be used as a main sources to evaluate



governmental performance as to meet transparency and accountability obligations to public. PP No. 6/2008 is about guidance to evaluate local governmental performance, as part of effort to reached Good Government Governance as mentioned in the EKPPD.

By using measurement EKKPD and LKPD as specific measurement applied to local governmental organization, we proposed the 3rd hypotheses as follows:

H₃: positive association between *organizational learning* and organizational performance

RESEARCH METHODS

Data and Sample

This research used survey method, populations of this research is all of staff of local government of Bogor City. Sample as unit analysis is staff of local government of Bogor City which works by using software SIMDA produced by BPKP. This questionnaires distributed directly to 118 candidates respondents from 37 SKPD (Satuan Kerja Perangkat Daerah) and 7 staffs from BPKAD (Badan pengelolaan Aset dan Keuangan Daerah). This research give one week for respondents to fill in questionnaires and directly collected by researcher.

The following is detail respondents:

1.	37 SKPD 3 staff each	total 111 respondents
2.	7 persons at BPKAD	<u>total 7 respondents</u>
Total		118 respondents

Research Model (Operationalization Research Concept)

Measurement by using previous literatures and there are some adjustments due to conditions of local government of Bogor City. The adjustments are regarding about marketing concept, customer and customer satisfactions, which focused on services provided to society of local government of Bogor City. Next, we will explained about some concepts of variable as unit analysis, consists of IT Competence, Organizational learning, Kinerja Organisasi and control variable.



Concept definitions

IT Competency (ITCOMP)

By using 7 points *likert scale* to operationalization 3 dimensions of IT Competency IT knowledge, IT Knowledge (ITKNOW), IT Operations (ITOPS) and IT Object (ITOBJECTS). This scale is scale by theoretical owned by domains in the marketing and researcher will use this scale, even though location of research is in the local government, the argue are society of local government of Bogor city, analogy as customer that should be serviced by staff or human resources of local government of Bogor City. Next, we referred to that 7 points of likert scales referred to expert on marketing (Glazer, 1991), Information Technology (Mata, Fuerst, and Barney, 1995), and information knowledge (Contrator and Eisenberg, 1990).

Organizational Learning (ORGLEARN)

Operationalization of dimensions of ORGLEARN used 7 points skala likert scale, and dimension of information Acquisition (INFOACQ) measured by scale which adapted from Baker and Sinkula (1999). Meanwhile, item used to measure dimensions of *information Dissemination* (INFODISS) adapted from Baker and Sinkula (1999) and Kohli, Jaworski and Kumar (1993).

Next, dimensions of scale adapted by Slater and Narver (1995) and Moorman and Miner (1998), those dimensions are: shared interpretation (SHARINT), Declaration Memory (DECMEM) and procedural Memory (PROC MEM).

Firm Performance (FIRMPERF)

In the context of Local government of Bogor City as respondents of the research and unit analysis are human resources who works by using software SIMDA by BPKP, we used score of EKPPD that sources from LKPD.



Control Variable

Variable to control performance variance of local government Bogor City are: characteristic of size, populations and original local government revenue (PAD) and Brutto domestic regional revenue /PDRB (by BPS)

Concept Operationalization

Table 1. Research Concept Operationalization

Variable	Dimensions	Indicator
1. IT Competency	IT Knowledge	<ol style="list-style-type: none"> 1. Technical support staff with sufficient knowledge 2. IT expert 3. IT innovation
	IT Operations	<ol style="list-style-type: none"> 1. Skill to analyzed information 2. Computerized system to accessed information 3. Online procedures 4. Computer system to analyzed information 5. Utilized supporting system to make a decisions 6. Computer system to save information
	IT Objects	<ol style="list-style-type: none"> 1. Have Department MIS formally 2. PIC to manage IT 3. Budget for upgrading TI hardware 4. Customized application software 5. Networking inter staff
2. Organizational Learning	Information Acquisition	<ol style="list-style-type: none"> 1. meeting by routine to know demanding of society 2. research to know the needs of society 3. society as source of information



		<p>4. Asking society about needs and wants</p> <p>5. collect information about society demands</p> <p>6. Collect information demand per sector and per society</p>
	Information Dissemination	<p>1. Various information are normative</p> <p>2. Accessible information</p> <p>3. Representative of department to discuss about society needs</p> <p>4. Society information undistributed to other department</p> <p>5. Transparency of information</p> <p>6. Accessible of society information</p>
	Shared Interpretation	<p>1. Different opinion about society needs</p> <p>2. Different opinion on service excellent to society</p> <p>3. In case know information about society and have same opinion on impact to governmental staff</p> <p>4. Have same opinion on understanding society needs</p> <p>5. Have same opinion how to service society</p>
	Declarative Memory	<p>1. Hold information about society goal</p> <p>2. Hold information about society competitiveness</p> <p>3. Know the weakness of society</p> <p>4. Know position of society</p> <p>5. Know R &D of society</p> <p>6. Know main goal of society</p> <p>7. Previous strategy to face society is known</p>



	Procedural Memory	<ol style="list-style-type: none"> 1. Have SOP to service society 2. Based on previous experience can service demanding society 3. Have SOP to know needs of society 4. Have SOP to face complaint of society 5. Experience teach what questions suitable for society
--	--------------------------	--

3. Firm Performance	Firm	Customer Retention
		Sales growth = Growth of Original Local Revenue (PAD)
		Profitability = Not applicable (NA) to local government
		Return On Investment =Not Applicable to local government
4. Market Power	Market	Market Share=NA
		Firm Size = ukuran daerah

Data Analysis

This research used survey method, populations are all of staff of local government of Bogor City. Unit analysis of the research is staff or personnel of local government of Bogor City using software SIMDA produced by BPKP. Distribution of questionnaires directly to candidates of respondents 118 people which consists of 37 SKPD (Satuan Kerja Perangkat Daerah) and 7 staffs of BPKAD (Badan pengelolaan Aset dan Keuangan Daerah). Respondents have One week to fill the questionnaires, and will collected directly by researcher.

Method used to test model is using factors analysis (confirmatory factor analysis), meanwhile, for *software* this research used Lisrel (Sudarmanto, 2005; Sugiarto, 2006; Sarwono, 2007).



RESULTS AND DISCUSSIONS

This research is using survey approach, and tools is questionnaires. We sent 118 questionnaires, returned 100 questionnaires (84.75%). Questionnaires distributed directly to respondents and already pilot test questionnaires before distributing to make sure that respondents full understanding about each questions in the survey.

Followings are detailed of sample respondents distribution and returned:

37	KPD each <u>total</u>	7 respondents
Total		118 respondents
Returned Questionnaires		100 respondents
%	level of returns	84.75%

Table 2 describes statistic descriptive of respondents of this research, they are human resources of local government of Bogor City in the 2016. If we looked from department, 26% respondents are BPKAD Bogor and the rest 62%, meanwhile respondents majority is Man for about 60%. If we look from position, majority is clerical 51% and 37% is guarding administration. From age, majority respondent in the productive age, it means successor aspects are on the tract, majority for about 51% on the age of 31-40 years. From leveling of position, dominate by level III for about 82%, and for training is very good due to 33% of respondents join trainings 3x and majority 43% on that position for about 4 years, it means that i=one staff should 4 years in the same position before getting promotion, so expected that staff already get enough knowledge and experience before promoting.



Table 2. Variable Statistic Descriptive Demography Respondents

N o.	Variable	Category	Frequency	Percentage
1	Departments	BPKAD Kota Bogor	26	26,0
		Bogor Selatan	5	5,0
		Bappeda	3	3,0
		BPBD	4	4,0
		Others	62	62,0
		Total	100	100,0
2	Sex	Man	60	60,0
		Woman	40	40,0
		Total	100	100,0
3	Level	Clerical	51	51,0
		Pengadministrasi pengawasan	37	37,0
		Kasi pemerintah	1	1,0
		K.SeksiSarkominfo	1	1,0
		Others	10	10,0
		Total	100	100,0



4	Age	< 25 years	8	8,0
		25-30 years	11	11,0
		31-40 years	51	51,0
		41-50 years	28	28,0
		> 50 years	2	2,0
		Total	100	100,0
5	Level	Gol IV	3	3,0
		Gol III	82	82,0
		Gol II	15	15,0
		Total	100	100,0
6	Education	Senior high school	11	11,0
		D3	5	5,0
		S1	64	64,0
		S2	20	20,0
		Total	100	100,0
7	training	None	15	15,0
		1 times	24	24,0



		2 times	15	15,0
		3 times	13	13,0
		> 3 times	33	33,0
		Total	100	100,0
8	Period of positions	2 years	30	30,0
		4 years	43	43,0
		5 years	13	13,0
		6 years	6	6,0
		> 6 years	8	8,0
		Total	100	100,0

**Table 3. SEM Result
Estimated Parameter**

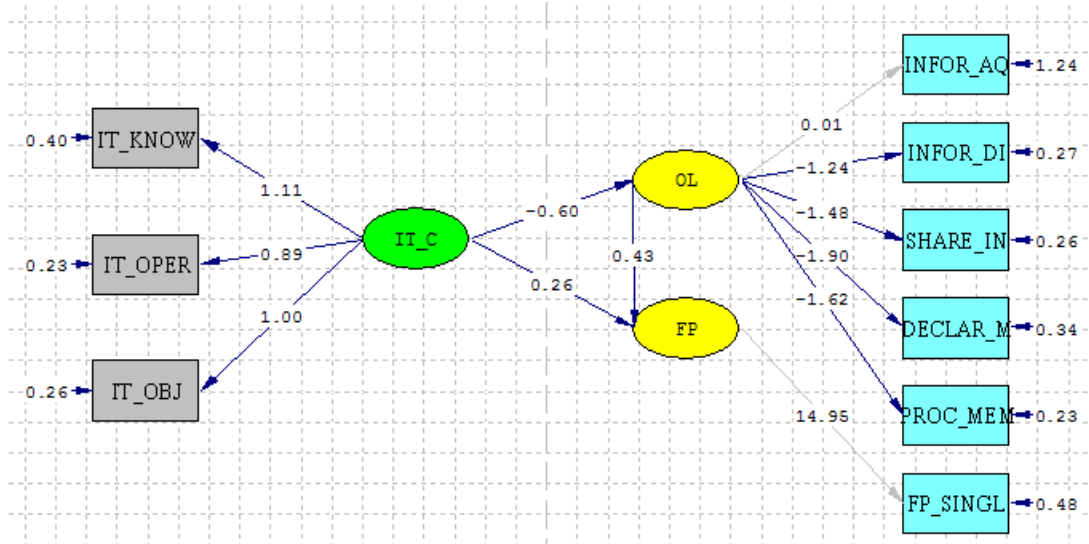

Based on Table 3 parameter estimation provided by analyzed structural Equation Model (SEM) which referred to method introduced by Singh, Goolsby and Rhoads (1994). Analysis result of table 3 findings are direct and indirect association between IT competence and organizational performance. By using proxy human resources performance. There are mediating variable on learning organization variable on the association of IT competence to Organizational performance.

In the detail, we observed there are variance value larger than organizational performance when IT competence through mediating partial by organizational learning variable. Then, there are positive association between IT Competence through learning organization. Next, through direct association, there are significant impact between IT Competence and Organizational performance.

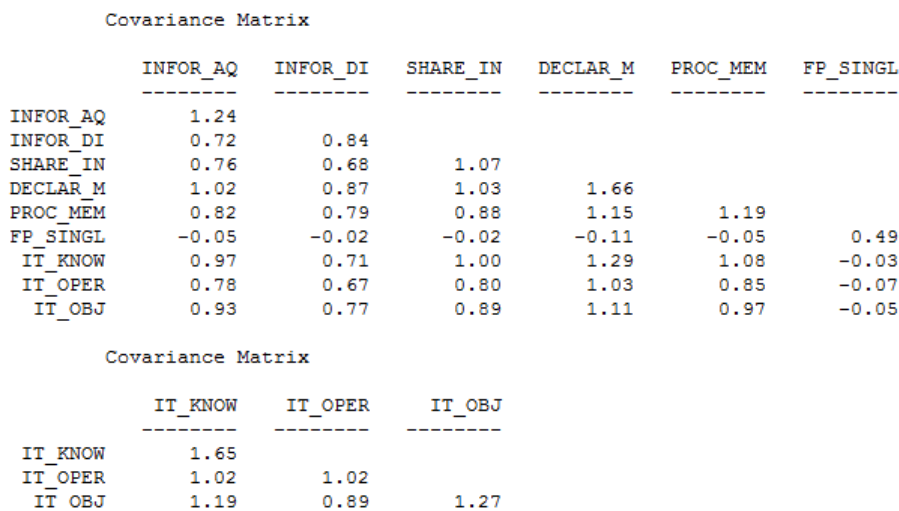

Figure 2

Table 4. Test of Fit the Overall Model

Measurement of GOF	Level of target fit	Estimation result	Level of fit
Chi-square	$p \geq \alpha$	P=0,000001 Chi-square = 0,000008	fit
RMSEA	RMSEA \leq 0,08 model fit	RMSEA = 0,001 P= 0,00001	fit

Based on table 4 to test good of fit the model of research, by using measurement of Goodness of Fir Chi_Square and RMSEA we finds level of good of fit is fit. So, we hope the result concluded that support all the research hypotheses and ovoid from bias conclusions.

Limitations of the research are the quantity of sample very limited, and also the proxy to measure organizational performance are human resources performance by personnel department. In keeping objectivity performance evaluations, better used performance per agency or per department, as respondent of this research are head of department/ agency. This is an opportunity for future research.

CONCLUSIONS AND SUGGESTIONS

This research proved that IT components influenced organizational performance and IT components effects on the organization performance and mediating organizational learnings. Based on the result, this research suggests if we evaluate IT competence we should focused on technology specific aspect, they are, 3 interactive components: IT Objects, IT Knowledge, and IT Operations. So, 3 (three) IT aspect should exists in the company in order to achieved IT Competence.

Based on this research, we found that IT success is not standing alone, but non only should inherent with organizational strategy, but also to be supported by the organizational strategy. For this research, it could be the opportunity for future research by added variable strategy with many aspects. Next, IT contributed to support success and sustainability of company. The result support all research hypotheses and give contribution of managerial aspects of organizations.

There are so many limitations of the research, such as for generalization aspect of the findings, whether the findings could applied to industries or other entities, since the sample of this research is in the governmental organizations, especially in the local governmental organizations. As we noted, that each local government in Indonesia have specific characteristics those will influenced the application of this research findings. The characteristics of the local government, such as, the populations, the original local revenue or income, the environmental uniqueness of local governmental.

The suggestions of the research findings are in order organization to improve the performance, variable IT components is one factor that have association with the organization performance and variable organizational learning have a mediating effect. It means organizational learning in the organizations is a variable can empowered association of IT Competence variable to organizational performance, which measured by profit, return on investment.



REFERENCES

- Baker WE Sinkula JM. (1999). The synergistic effect of market orientation and learning orientation on organizational performance. *Journal of the Academy of Marketing Science* 27 (4): 411-427
- Barney JB. (1991). Firm resources and sustained competitive advantage. *Journal of Management* 17 (1): 99-120.
- _____, Wright M, Ketchen DJ Jr. (2001). The resource-based view of the firm: ten years after 1991. *Journal of Management* 27: 625-641
- Bettis RA. Hitt MA. (1995). The next competitive landscape. *Strategic Management Journal*, Summer Special Issue 16, 7-19.
- Cash J, Konsynski B. (1985). IS redraw competitive boundaries. *Harvard Business Review*, 11 (2-3), 143–181.
- Clemons EK. (1986). Information system for sustainable competitive advantage. *Information and Management*, 11: 131-136.
- _____, Ge, Row MC. (1991). Sustaining IT Advantage the role of structural differences . *MIS Quarterly* 15(3): 275-294.
- Contractor NS, Eisenberg E. (1990). Communication networks and new media in organization. In *Organizations and Communication Technology*, Steinfield C (eds). Sage: Newbury Park , CA; 143-172.
- Davenport TH, De Long DW, Beers MC. (1998). Successful knowledge management project. *Sloan Management Review*, Winter : 43-57.
- Dewett T, Jones GR (2001). The role of information technology in the organization: a review, model, and assessment. *Journal of Management*, 27: 313-346.
- Dollinger MJ. (1984), Environmental boundary spanning and information processing effects on organizational performance . *Academy of Management Journal* 27(2): 351-368.
- Glazer R. (1991). Marketing in an information-intensive environment: strategic implication of knowledge as an asset. *Journal of Marketing* 55 (October): 1–19.
- Granstrand O. (1982). *Technology Management, and Market*. St Martin’s Press: New York.



- Hitt LM, Brynjolfsson E. (1996). Productivity, business and profitability, and consumer surplus: three different measure of information technology value . *MIS Quarterly* 20(2): 121-143.
- Hope J, Hope T. (1997). *Competing in the Third Wave*. Harvard Business School Press: Boston, MA
- Itami H. (1987). *Mobilizing Invisible Assets*. Harvard University Press: Cambridge, MA
- Kohli AK, Jaworski BJ, Kumar A. (1993). MARKOR: a measure of market orientation. *Journal of Marketing Research* 30 (November): 467-477.
- Lei D, Hitt MA, Bettis R. (1996). Dynamic core competencies through meta-learning and strategic context. *Journal of Management* 22(4): 549-569
- Lucas HC. (1999). Information technology and the productivity Paradox. *Oxford University Press*: New York
- Mahmood M, Mann GJ. (1993). Measuring the organizational impact of information technology investment: an exploratory study. *Journal of Management Information Systems* 10(1): 97-122.
- Maier JL, Rainer RK Jr, Snyder CA.(1997). Environmental scanning for information technology; an empirical investigation. *Journal of Management Information System* 14(2): 177-201.
- Maltz E, Kohli AK. (1996). Market intelligence dissemination across functional boundaries. *Journal of Marketing Research* 33(zzfebruary): 47-61
- Mata FJ, Fuerst WL, Barney JB. (1995). Information technology and sustained competitive advantage: a resource based analysis. *MIS Quarterly*, December: 487-504.
- Mitcham C, Mackey R.(1983) . Philosophy and technogy: Reading in the philosophical Problems of technology. *Free press*: New York.
- Moorman C, Miner As. (1997). The impact of organizational memory on new product performance and creativity. *Journal of Marketing Research* 34(February): 91-106.
- Moorman C, Miner (1998a). The convergence of planning and execution: improvisations in new product development. *Journal of Marketing* 61(July): 1-21
- Nault BR, Dexter AS. (1995). Value added and pricing with information technology. *MIS Quarterly* December: 449-463



- Nelson RR, Peck MJ, Kalachek ED. (1967). Technology Economic Growth, and Public Policy. *Brookings Institution*: Washington, DC.
- Peraturan Pemerintah (PP) No. 3/2007 tentang Laporan Pertanggungjawaban Pemerintahan Daerah. (LPPD)
- Peraturan Pemerintah (PP No. 6/2008 tentang Evaluasi Kinerja dan Penyelenggaraan Pemerintah daerah (EKPPD)
- Peteraf M. (1993). The cornerstone of competitive advantage: a resource-based view: *Strategic Management Journal* 14(3): 179-191.
- Powell TC, Dent-Mitchellef A. (1997). Information technology as competitive advantage: the role of human, business, and technology resources. *Strategic Management Journal* 18(5): 375-405.
- Sampller JI. (1998). Redefining industry structure for the information age. *Strategic Management Journal*, Special Issue 19: 343-355
- Seibert SE, Kraimer ML, Liden RC. (2001). A social capital theory of career success. *Academy of Management Journal* 44(2): 219-237
- Simonin BL. (1997).The importance of collaborative know-how: an empirical test of the learning organization. *Academy of Management Journal* 40 (5): 1150-1174.
- Slater SF, Narver JC. (1995). Market Orientation and the learning organization. *Journal of Marketing* 59(July): 63-74.
- Taylor JC. (1971). Technology and Planned Organizational Change, *Braun-Brumfield*: Ann Arbor, MI
- Tippin MJ, and Sohi Ravipreet S. (2003). IT Competency and firm performance: Is organizational learning a missing link?. *Strategic Management Journal*. (24): 745-761.



**RESPONSIBILITY DESIGN MODEL & FINANCIAL DISCLOSURE BASED ON
WEB-ICT WITH INDEX FULL DISCLOSURE METHOD FOR GOOD
GOVERNANCE GOVERNMENT IN INDONESIA REGENCY AND CITY
(EMPIRICAL STUDY ON ENTIRE LOCAL GOVERNMENT REGENCY AND CITY
IN INDONESIA)**

Bambang Jatmiko

Nano Prawoto

Rini Juni Astuti

Kholifah Fil Ardhi

Universitas Muhammadiyah Yogyakarta

kholifahfilardhi@gmail.com

Abstract

The purposes of this research are to prove empirically about: Financial Statement Disclosure in Entire Indonesian Province; to prove empirically about The Condition of Local Government Internet Web; to prove empirically about Financial Statement Disclosure Design Method based on Web-ICT with index full disclosure method to realise the local government performance and good governance government in Indonesia. The problem formulation in this research is that the average of financial statement disclosure conducted by each local government in Indonesia are below 50%. In addition, the use of internet in searchings of news information into second place by 78.49%, in searchings of information on goods and services are third at 77.81%, while information retrieval government institutions ranked fourth amounting to 65.07%. The research method is descriptive method, the research objects all of the Local Government in Indonesia, and uses purposive sampling techniques. The result are that the disclosure of financial statement across the province can be explained as follows: Balance (47%); Realization Report and Budget (60%); Cash Flow Statement (50%); Notes to the Financial Statements (17%). For financial statement disclosure all cities in Indonesia: Balance (28%); Realization Report and Budget (39%); Cash Flow Statement (23%); Notes to the Financial Statements (10%). While the disclosure of financial statements



of all districts in Indonesia: Balance (18%); Realization Report and Budget (29%); Cash Flow Statement (13%); Notes to Financial Statements (7%). Supreme Audit Agency (BPK) in 2013 discovered 1,871 cases of alleged violations of the rules of the Local Government Finance Report (LKPD) and Regional Owned Enterprises (enterprises) in the second half of 2012. The value reached Rp 1.17 trillion.

Keywords: Financial Statement Disclosure, Web, Disclosure

JEL Classifications: H83, G34

INTRODUCTION

Common phenomenon of Act No. 22 of 1999 regarding local government organize local autonomy has changed the process of governance in Indonesia. The regional governments get the full power of center governance to organize and administer the region through their own initiative. As a consequence, local governments should be able to plan a budget and be accountable for budget management in each period. In Indonesia, the mechanism of financial management accountability that must be done by the local government is only limited to the submit financial statements that have been audited by BPK to Parliament, but after the issuance of Law No. 14 of 2008 on Public Information, which provides that public officials should be more transparent, accountable and more oriented to community service, the financial transparency are things that need to be done by the local government. One form of transparency that the local government can do is to voluntarily disclose financial reports on the Internet so that all stakeholders have an opportunity to obtain the information in the regional government (Afryansyah, 2013). This thing is supported by the development of Internet technology in Indonesia as it is today is so rapid. Proved by the increasing internet users in Indonesia each year.

Based on data released by BPS (Central Bureau of Statistics), in collaboration with the Association of Indonesian Internet Service Provision (APJII) recorded a growth rate of Internet users in Indonesia by the end of 2013 had reached 71.19 million people. The phenomenon reflects that the use of the Internet as an information medium has become a necessity that cannot be separated in social life as it is today. Not only because the cost of its



use is relatively cheap but also quick and ease access information are strong reason why the Indonesian people use the Internet.

Special phenomenon, seven years after the law on public information openness but until now the problem of transparency of financial management is still a difficult thing to be realized by the local government. In fact, by looking at the rapid development of Internet usage among the public at this time, make the Internet as one of the main communication media in disclosing the financial statements is the right step that can be done by local governments. Based on the results of observations made before doing the study, showed that the average disclosure of financial statements performed by every type of local governance in Indonesia is still below 50%. These results indicate that the low level of disclosure of financial statements conducted by the local government and increasingly proving yet transparent financial management processes that exist within the local government. Therefore, financial statement disclosure issues remain a problem that must be addressed and improved by the government regions in Indonesia.

This is in contrast to what is done by the private sector which in its business operations reporting to stakeholders, the private sector makes the Internet a top priority as seen from the efficiency and effectiveness of highly profitable internet. Proved that people in Indonesia more frequently seek information on the private sector than by seeking information about their local governance. This was in line with the results of a survey conducted by BPS, that the use of the internet in search of news information into second place by 78.49%, to search information on goods and services are third at 77.81%, while information retrieval rank government agencies four of 65.07%.

Based on the above data, the local government should maximize the role of the Internet in an effort to make government more transparent and accountable, so that the public interest to seek information about their local government will increase. Therefore, it is necessary to investigate what factors influence the motivation of the local government in disclosing the financial statements to the public.

The problem formulations in this study are as follows: (1); How is the Financial Statement Diclosures in the entire Indonesian Province; (2) How is the condition of Internet website of Local Government; (3) What is the pattern design of financial statement



disclosures based on Web-ICT with full disclosure index method for achieving good governance government Local governments in Indonesia. The purposes of this study are to prove empirically: Financial Statements in entire Indonesia Province; To prove empirically the Internet Web Site Conditions of Local Government; To prove empirically the pattern of financial statement disclosures based on Web-ICT with full disclosure index method to realize the performance and good government governance Local Government in Indonesia.

LITERATURE REVIEW

Financial Statement and Indicators Disclosures

Disclosure is an integral part of the financial reporting and the final step in the accounting process that is the presentation of information in the form of a full set of financial report. According to Evans in Suwardjono in Rahman, et.al (2013) classifies three levels of disclosure as follows:

- a. Adequate disclosure is the minimum level that must be met in order for the overall financial statement that is not mislead in the interests of the directional decision.
- b. Fair or ethical disclosure is the rate that must be achieved so that all parties are treated the same or informational services. That is, no one that less informed so that they become the less advantaged position.
- c. The full disclosure requires the presentation in full all of the information that interlock with decision

Disclosure can be divided into two kind, namely the mandatory disclosure and voluntary disclosure. Mandatory disclosure is the disclosure of information that is based on the applicable legislation, in this case the party who has the authority to establish regulations is Capital Market Supervisory Agency (Bapepam), whereas the voluntary disclosure is a disclosure is made voluntarily by the company without guided by regulations or disclosure in excess of that required. According Suwardjono in Rahman et.al, (2013), the general purpose of the disclosure is to present information that is necessary to achieve the objectives of financial reporting and to serve the various parties who have different interests. The capital market is the main vehicle for the fulfillment of the funds from the public, therefore,



disclosure may be required for the purpose of protecting the rights that should be available to the public. Disclosure is intended to protect from management behavior that is sometimes less than fair and open. What should be disclosed to the public is limited to what is deemed beneficial for the intended wearer while for monitoring purposes, certain information must be submitted to monitoring board or watchdog by regulation through the forms that demand detailed disclosure Rahman et.al, (2013). Local government financial reporting present information that is useful for users in assessing the accountability report and make a good decision-making economic, social or politic.

The government financial reporting purposes are as follow: a) provide information on whether the acceptance period runs enough to cover all the expenses. b) provide information on whether the obtaining of economic resources and allocations in accordance with a set of budget and legislation. c) provide information on the amount of economic resources that being used in the activities of local governments and the results that have been achieved. d) provide information on how the regional government to fund its operations and meet its cash needs. e) provide information about the financial position and the condition of local governments with regard to the sources of revenues, both short term and long term, including those derived from taxation and borrowing. f) provide information about changes in financial position of local government, whether an increase or decrease, as a result of activities undertaken during the reporting period.

Research conducted by Arifin (2014) examined mandatory financial statement disclosure of Local Government used Government Compliance Index (GCI). There are 57 items in this index however Arifin (2014) only used 7 items they are as follow; Fiscal Policy, Macro Economy, Budget Target (APBD), Financial Performance, Accounting Policy, Financial Statement item and non-financial information.

Financial Statement of Local Government

Based on the Statement of Government Accounting Standard No. 1 on presentation of financial statements, the financial statements are a structured report on the financial position and transactions undertaken by a reporting entity. The general objective of financial statements is to provide information regarding the financial position, the realization of the



budget, cash flow, as well as the financial performance of a reporting entity that is useful to users in making and evaluating decisions about the allocation of resources. According to Sinaga (2011) the objective of government financial reporting specifically is to present useful information for decision-making and to demonstrate accountability reporting entity for the resources entrusted to them, by the way:

- a. Provide information on the position of economic resources, liabilities, and equity of government funds.
- b. Provide information about changes in the position of economic resources, liabilities, and equity of government funds.
- c. Provide information about the source, allocation and use of economic resources.
- d. Provide information on adherence to the realization of the budget.
- e. Provide information on how the reporting entity to fund its activities and meet its cash needs.
- f. Provide information on the potential of governments to finance implementation of the activities of government.
- g. Provide useful information to evaluate the reporting entity's ability to fund its activities.

General purpose financial statements also have a predictive role and prospective, and it provides useful information to predict the needed amount of resources for sustainable operations, the resources generated from continuing operations, as well as the risks and uncertainties associated. Financial reporting also provides information to users about:

- a. Indication of whether resources were obtained and used in accordance with the budget.
- b. An indication of whether the resources obtained and used in accordance with the provisions, including the budget limit set by the DPR / DPRD.

A financial statement should have a complete component composition. The components that must be present in a set of basic financial statements are:

- a. Budget Realization Report



Presenting an overview of sources, allocation and use of economic resources managed by the local government, which illustrates a comparison between its budget and realization in a reporting period.

b. Balance

Balance describes the financial position of local governments on the assets, liabilities, and equity funds on a specific date.

c. Cash Flow Report

Statements of cash flows presents the information about source, usage, changes in cash and cash equivalents during the accounting period, and the balance of cash and cash equivalents on the reporting date.

d. Notes to The Financial Statements

Notes to the financial statements is some narrative explanation or details of the numbers listed in the budget realization reports, balance sheets and cash flow statements.

E-Government

E-government or electronic government is a process of government systems by utilize ICT (Information, Communication, Technology) as a tool to facilitate communication processes and transactions to the public, business organizations and between government agencies along with their staff, in order to achieve efficiency, effectiveness, transparency, government accountable to the people (Hartono in Medina, 2012). The development of e-government is an attempt by the government to improve the quality of public services through electronic media to the public. Implementation in the development of e-government are directed to reach the four main objectives, (Instruction No. 3, 2003) are as follow:

- a. Establishment of information networks and public services transactions that have the quality and scope to satisfy the wider community and accessible in all parts of Indonesia at any time is not limited by barriers of time and at a cost that is affordable by the community.



- b. Establishment of an interactive relationship with the business community to improve the development of the national economy and strengthen the ability to face changes and international trade competition.
- c. Establishment of mechanisms and channels of communication with state institutions and the provision of public facilities for community dialogue in order to participate in the formulation of state policy.
- d. Establishment of management systems and processes that work transparently and efficiently and facilitate transactions and services among government agencies and the government of the autonomous region.

Implementation of e-government requires preparations to be thoughtful for the purpose of implementation can be achieved. According to Hartono Heeks in the Medina (2012) load that things need to be prepared by local governments in the implementation of e-government efforts are:

a. Legal Infrastructure

Legal Infrastructure are necessary to tackle digital crime, and to protect privacy, security of data / information and digital transactions of individuals, businesses, and government agencies.

b. Institutional Infrastructure

Specialized institutions are necessary to handle e-government that provides information services to the community including digital services.

c. Human Resources Infrastructure

Personnel system should be developed to be able to attract qualified human resources in the field of telematics to participate in the development of e-government in government property.

d. Technology Infrastructure

Although the technology required is relatively expensive, but the business opportunities of cooperation with the private sector should be developed in building the technology infrastructure to support e-government.

e. Support, Capacity, Value



- f. Political environment, Leadership, Planning, Stakeholder, Transparency, Budget, Technology, Innovation.

The benefits of e-government in supporting the effectiveness and efficiency of public services can be seen from the three dimensions of economic, social, and governance (Misuraca in Anissa, 2011).

a. Economic Dimension

In economic terms, the benefits of e-government are to reduce transaction costs for a better capacity to service target, increasing coverage and quality of service delivery, boost the response capacity in addressing the issue of poverty issues and increase revenue.

b. Social Dimension

In social terms, the benefits of e-government quite diverse ranging from job creation in the third sector, improving the education system and health, better targeting on government services, increase capacity in the provision of safety and security. In many cases these benefits can be evaluated in terms of politics and can be quantified in financial terms.

c. Government Dimension

In terms of government, the benefits of e-government can improve the achievement of good governance in terms of increased openness, transparency, accountability or democracy than conventional government. E-government can also increase community participation, so that it can strengthen the existing democratic system.

Good Governance Government

Good Governance Government is a form of application of the principles of good governance in government circles, both national and local. In addition to good government governance (GGG), Good Government, also divided on Good Corporate Governance (GCG) and Good University Governance (GUG). GUG is the application of the principles of good governance in a university or college, GCG is the application of principles of good governance at the company. In essence, good governance is a process that emphasizes on



how an organization can improve its performance and the creation of civil society. Some researchers disclose the definition of good governance in different ways. LAN in Garnita (2008) revealed that good governance is the process of the state power in implementing the public provision of goods and service. Good governance of an organization is that based on professional ethics in business / working. Understanding of good governance is a form of acceptance of the importance of a set of rules or good governance to regulate relations, functions and interests of the various parties in business or public service (Trisnaningsih, 2007). Good governance is also intended as a managerial capabilities to manage resources and affairs of a country by means of an open, transparent, accountable, equitable and responsive to community needs (Widyananda in Wati et al., 2010).

The implementation of good governance in an organization, both private and public organizations have many benefits. One of the benefits that can be gleaned by implementing good governance is improving company performance through the creation process of better decision making, increase its operational efficiency and further improve service to stakeholders (FCGI in Trisnaningsih, 2007). Good governance government contains several principles. Some researchers revealed the principles of good government governance in different ways, including: Dedi in Sari (2013) revealed that the conceptual understanding of governance both containing two understandings they are the value that upholds the desire or the will of the people, and the values that can be improve the ability of the people in achieving the goal of independence, sustainable development and social justice. The quality of local government currently and future is determined by the quality of good governance. Good governance contains some principle. Badjuri and Trihapsari in Wati et al. (2010) revealed that in the good governance is characterized by three main pillars which are basic elements that are interrelated. These three basic elements are participation, transparency and accountability. Sari (2013) reveals that the principles of good governance such as transparency, openness, accountability, participation, fairness, and independence should be there in good governance. Rahadian (2008) says that values such as efficiency, equity, transparency, participation, and accountability can be measured easily in the practice of public service.



Garnita (2008) describes the principles of good governance are as follow:

a) Transparency

Transparency requires the existence of an open information systems, on time and clear comparable concerning the financial condition, corporate management, and ownership of the company.

b) Fairness

Fairness is meant to guarantee the rights of shareholders, including the rights of minority shareholders and foreign shareholders, as well as ensure the implementation of commitments by investors.

c) Responsibility

Responsibility is intended to ensure compliance with the rules and regulations of compliance as a reflection of social values.

d) Accountability

Accountability is intended to clarify the roles and responsibilities and to support efforts to ensure balancing the interests of management and shareholders, as supervised by the commissioner.

e) Interdependency

Interdependency is intended as a situation where a professionally managed company with no conflicts of interest and influence or pressure from any party that is not in accordance with the applicable legislation of the principles of healthy cooperatives.

Website

The website is a collection of pages of information that shows text data, the data is a null or moving image, animation data, voice, video or a combination of them, whether they are static or dynamic that forms a series of interconnected buildings relating in each connected through networks page (hyperlink). The website itself is a collection of web pages saved in a server / hosting, and identified through a name that also referred to as a domain or sub-domain. ([http://id.wikipedia.org/wiki/Situs web](http://id.wikipedia.org/wiki/Situs_web)). The website is divided into two kinds, namely the nature of the website is static and the dynamic websites. The website is static if



the information in it is fixed, rarely updated, does not have the features or do not have a programming system that allows visitors interact directly with the website owner or other person who also allowed to access the website. Static websites do not have a page where the page's administrator can do the process of updating the website content such as writing new articles, create new pages and upload the image file. The examples of this type of website is a website company profile.

Additionally, the website is dynamic if contain information therein is changeable, and has a programming system or features that allow web visitors to interact directly with the owner of the web or other people who are also accessing the web through the features provided. Dynamic website also has a page administrator. From page administrator the owner or user can perform editing website content, either edit content, add articles, links between pages, upload images or videos etc., these can be done from the admin page. Examples of these types of websites are Facebook, Twitter, and news sites like detik.com, okezone.com and others.

Previous Research

Based on past studies, such as research conducted by Sinaga (2011), which examined the financial reporting voluntarily by the local government on the internet showing the results that only leverage and the type of government that a significant negative effect on the financial reporting voluntarily on the internet. In addition, for the three other variables such as political competition, the size and wealth have no significant effect on the financial reporting voluntarily by the local government on the internet. The next research conducted by Medina (2012) shows that the results of the local government size, the ratio of local government autonomy and complexity positively affect on the availability of financial information on the official website of the local government, while the per capita income of the people and leverage affect adversely on availability of financial information on the official website of the local government. The subsequent research conducted by Rahman et al (2013) which examined the factors that influence the local government financial reporting on the internet. The results from these studies showed that leverage, local government wealth, political competition proved to affect the reporting of financial information on the Internet,



while the size and type of government does not affect the reporting of financial information on the Internet. Subsequent research conducted by Afryansyah (2013) shows the results that the only press visibility variable has significant influence on the level of disclosure of accounting information on the internet, while size, the level of investment, regional wealth and political competition variables do not significantly influence the level of disclosure of accounting information in internet as voluntarily by the local government. Subsequent research by Hudoyo and Amir (2014), showed that the results of regional assets and leverage variables do not affect the financial reporting on the Internet by local governments in Indonesia, while the per capita income affect on Internet financial reporting by local governments in Indonesia. Based on research conducted by Laswad, Fisher & Oyelere (2005), some local governments in New Zealand has opted to provide disclosure of financial reporting on the internet. The results of the study on the disclosure of the internet will provide development activities transparency and accountability to financial reporting in New Zealand. Research conducted by Xiao, Yang & Chow (2004) companies in China are using the internet as a medium for the delivery of financial information (internet based corporate disclosure). Where, through internet based corporate disclosure can lead to higher profits in the economic field, especially in the capital markets to be able to provide direct information to stakeholders about the ownership of shares. In addition, there is research conducted by Laswad, Fisher, & Oyelere (2005) that the submission of financial statements as government can do with the internet media (internet financial reporting).

RESEARCH METHODOLOGY

Table 1

Research Object	⇔	The entire local government in Indonesia
Data Type	⇔	Secondary Data
Population	⇔	All local governments in Indonesia, both from the provincial, city and county. The number of local governments in Indonesia are as much as 34 provincial governments, 93 municipalities and 403 district administrations.



<p>Sampling Technique</p>		<p><i>Purposive sampling</i></p> <p>The sample in this study had to meet the criteria as below:</p> <ol style="list-style-type: none"> 1. The regional governments already have the financial statements audited by the Supreme Audit Agency (BPK) for the year 2012 and the financial statements can be obtained at the CPC. 2. The regional government has a website on the internet and the website can be accessed. 3. Data of local government financial statements have been audited, get the opinion of WTP, WTP DPP, or WDP in 2012 <p>The determination of the sample using the formula Slovin value $e^2 = 10\%$, according to the formula:</p> $n = \frac{N}{1 + (N \cdot e^2)}$ <p>Description :</p> <p style="padding-left: 40px;">n: number of sample N: number of population e^2: value leeway inaccuracy</p> $n = \frac{348}{1 + (348 \times 10\%^2)}$ $n = 77,68$ $n = 78$ <p>So sampling is obtained: 78 local governments</p> <p>Researchers will observe the 78th District and the entire City government in Indonesia from 348 local governments.</p>
-------------------------------	---	---

Index scoring	⇒	Category	Detail	Score
		The information contained	Number of budget	1
			Balance	1
			LRA	1
			LAK	1
			Audit Opinion	1
			Performance	1
			Restra	1
			CaLK	1
			Data from Last Year	0,75
			Segment Reporting	0,75
		Format	PDF	1
			HTML	0,75
			Flash	0,75
			Excel	0,5
			PPT	0,5
			Word	0,5
interaction with users	Email	1		
	Forum	1		
	Mailing List	1		
Tools	⇒	Model/Pattern/Design/ the pattern of government financial reports		

DISCUSSION

How Financial Statements in Entire province in Indonesia

In Indonesia, almost all local governments have an official website but the level of disclosure from one region to another is different. As a result, then occurs heterogeneity in which the disclosure of financial statements disclosed on the Internet ranging from the least to the most complete. The statement was confirmed by the observations of researchers on all official websites of local government in Indonesia as below:

Table 2. The Financial Statement Disclosures in Entire Indonesian Provinces with Have Accessable Website

Name	Score	Number of Local Government	Results	Percentage
Balance	14	30	0,466666667	47%
LRA	18	30	0,6	60%
LAK	15	30	0,5	50%
CALK	5	30	0,166666667	17%

Source: Official Website of Local Government

Table 2 shows the result of the financial statement disclosures included in the provincial government website in Indonesia. From the 34 provinces in Indonesia, only 30 provinces website can be accessed by researchers and a new average of about 43.5% in the Indonesian province that reveal financial statements on its website. Budget realization reports into components that are most often expressed in the amount of 60%. Lowest component disclosed are the notes to the financial statements amounted to only 17%, whereas The Notes of Financial Statement is a narrative explanation of the details of the figures contained in the financial statements and important to convey.



Tabel 3. The Financial Statement Disclosures in Entire Indonesian Cities with Have Accessable Website

Name	Score	Number of Local Government	Results	Percentage
Balance	23	83	0,277108434	28%
LRA	32	83	0,385542169	39%
LAK	19	83	0,228915663	23%
CALK	8	83	0,096385542	10%

Source: Official Website of Local Government

Furthermore, Table 3 is the result of observations conducted by researchers of the entire city government website in Indonesia. They show an average of only about 25% of the city government's website revealed the financial reports official site. The remaining approximately 75% is still not revealed its financial report. Budget realization report back to the component most often expressed in the amount of 39%. Notes to the financial statements into components that are disclosed lowest at 10%. The results showed that there are still many municipalities in Indonesia that have not made the transparency of financial management to the public.

Table 4. The Financial Statement Disclosures in Entire Indonesian Regencies with Have Accessable Website

Name	Score	Number of Local Government	Results	Percentage
Neraca	54	307	0,175895765	18%
LRA	88	307	0,286644951	29%
LAK	50	307	0,16286645	16%
CALK	21	307	0,068403909	7%

Source: Official Website of Local Government



Table 4 shows the results of observations of researchers to district governments in Indonesia website that can be accessed. The number of website district government, which can be accessed are 307 websites, and the average level of disclosure of financial statements by district governments in Indonesia around 17.5%, which means that there are still about 82.5% that have not made the disclosure. The data shows the budget realization reports back into a component that is often expressed in the amount of 29%, while the notes to the financial statements be disclosed lowest component that is equal to 7%.

According to Hadi, (2013) the Supreme Audit Agency (BPK) found 1,871 cases of alleged violations of the rules of the Local Government Finance Report (LKPD) and Regional Owned Enterprises (BUMN) in the second half of 2012. The value reached Rp 1.17 trillion. Chairman of the Supreme Audit Agency (BPK) Hadi Purnomo said the findings on thousands of such cases mostly occur in as many as 1,793 cases LKPD checks with a value of 1.15 trillion. "The rest occur in the examination of enterprises," Hadi said in Jakarta, Tuesday (04/02/2014). Hadi said that in the second half of 2012 BPK tested about 94 LKPD provincial / district / city in 2011. Thus, in 2012, the BPK has completed examination report (LHP) on 520 LKPD year 2011 budget of 524 local governments are required to formulate LKPD. "There are still four local governments that are late handing LKPD to CPC. In addition, we also have examined two LKPD 2010 and nine financial statements PDAM 2011, Hadi added, against 94 LKPD 2011, the BPK provides opinions are reasonable with the exception of (WDP) on 33 LKPD, opinions unnatural (TW) given to three LKPD and not give an opinion (TMP) on 58 LKPD. It is said, the results of the LKPD indicate that the provincial and municipal level governments gain a better opinion than the government district. In conclusion the district governments should be encouraged to improve the management and financial reporting.

Local Government Website in Indonesia

The survey results through media technology, the result shows that the local government internet website is a site located on the Internet that contains all the information about the condition of the local government. The information referred to include profiles of local government, regional potential, regional development and so on, according to



Soepriyanto and Aristiani, (2011). Government web sites is the development of e-Government by the government. It is based on the progress of development of information technology to support the development of local government. According Goechi.com (2010) that the government has been promoting the use of information technology in supporting the activities of government activities, both central and local governments towards the realization of e-Government, which is a concept to create new interaction and communication between local government and each other, between local government and central government, between the government and society, and between the government and the business world. Local Government website development objective is to support the promotion of regional development for its functions to progress and prosperity of a local community. Moreover, in terms of technological developments and the current information the website is a medium to deliver information, especially public information. According to Law No. 14 of 2008 Section 1 on Public Information, public information is information generated, stored, managed, delivered and / or received by a public body with regard to the organizers and the implementation of state and / or organizers and the organizing body other public in accordance with this Act as well as other information relating to the public interest. Thus, it can be concluded that public information is all the information needed by the public related to the respective interests of the public are also regulated by law. In this case the focus is the public information activities carried out by local governments, for the delivery and presentation of financial statements regions. As already mentioned in Law No. 14 of 2008 which states that one of the objectives on public disclosure is as follows realize good governance, namely transparent, effective and efficient, accountable and accountable.

Financial Statement Disclosure Model based on Web-ict with Index Full Disclosure Method to Realise Good Governance Government of Local Government in Indonesia

The consequences of disclosure of financial statements for the government to the public / stakeholders that exist greatly affect the existence of government. The consequence of financial statement disclosure can be in the form of budget absorption effectively and efficiently. The advantages of disclosure include: the presentation of financial performance, transparency and accountability in public service information.



Disclosure in the world of public services can play a role as Public Relation for Governance related to the community at any time so that through disclosure the public can understand the existence of a Good Government. Disclosure can also reduce risks for the Government and can improve liquidity. Voluntary disclosure will reduce information asymmetry among informed and uninformed society, so for governments with high disclosure levels will increase public confidence. Financial statement disclosure can reduce information of mistrust in the society. Disclosure can also reduce the investment risk for outside investors, so there is a sense of security in investing. Disadvantages with disclosure include implementation of disclosure can reveal the strategy to the competitiveness of government. Usually the local government is very sensitive in disclosing information that might reduce the competitiveness of the government, the cost to create disclosure, while the beneficiaries of the disclosure do not want to pay because they assume that the financial statements of the Local Government is a Good Public Government, and it increases the price of competitiveness to Local government.

The website of Local Government is a site located on the Internet and could be accessed electronically by means of devices such as computer or smartphone. This website contains all information about Local Government including Financial Statement Disclosure. Which means, all advantage and disadvantage are carried out by this media technology.



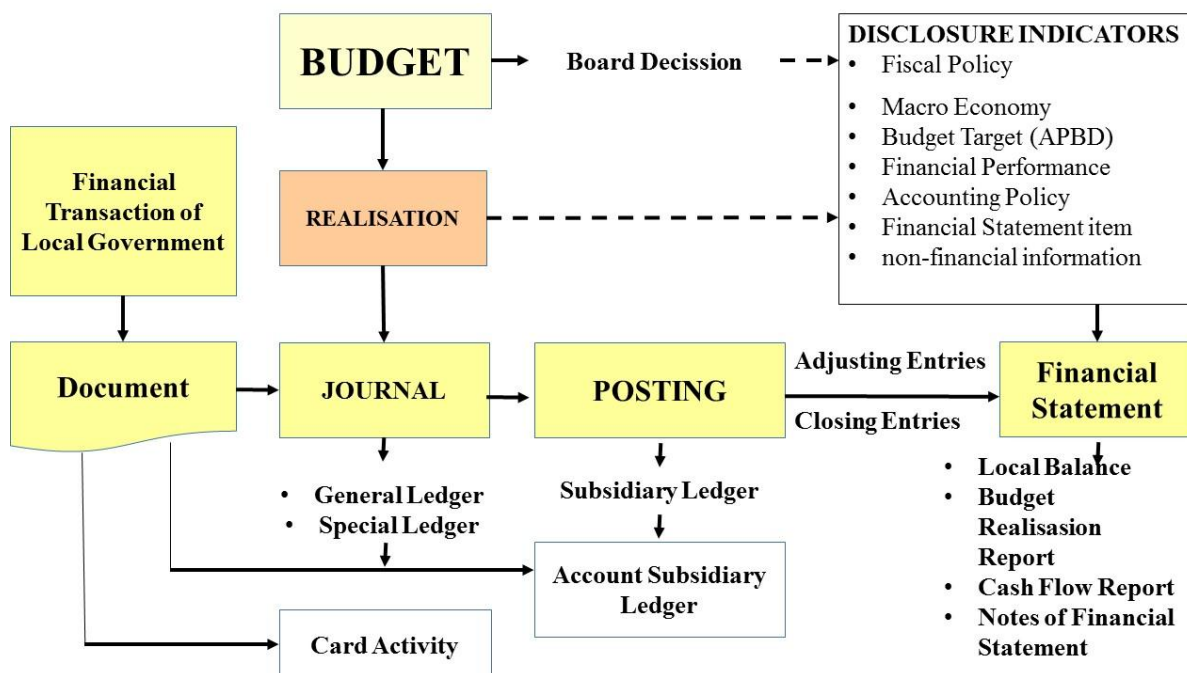

Figure 1. Financial Statement Disclosure Model

CONSLUSION, SUGGESTION AND IMPLICATION

Conclusion

In this study the average of disclosure of financial statements conducted by each local government in Indonesia is still below 50%. In addition, the use of the internet in search of news information into second place by 78.49%, to search information on goods and services are third at 77.81%, while information retrieval government institutions ranked fourth amounting to 65.07%. The research method descriptive method, the research objects in all of the Local Government in Indonesia, aside used purposive sampling techniques.

The results of financial statements disclosures across the province can be explained as follows:

1. Balance (47%); Realization Report and Budget (60%); Cash Flow Statement (50%); Notes to the Financial Statements (17%).

2. Disclosure of the financial statements of all cities in Indonesia: Balance (28%); Realization Report and Budget (39%); Cash Flow Statement (23%); Notes to the Financial Statements (10%).
3. While the disclosure of financial statements all districts in Indonesia: Balance (18%); Realization Report and Budget (29%); Cash Flow Statement (13%); Notes to Financial Statements (7%). Supreme Audit Agency (BPK) in 2013 discovered 1,871 cases of alleged violations of the rules of the Local Government Finance Report (LKPD) and Regional Owned Enterprises (enterprises) in the second half of 2012. The value reached Rp 1.17 trillion.

Suggestion

We recommend that future researchers can do the implementation and integration of the financial statements of both the districts and cities across Indonesia associated with the financial statements or village, so that would be obtained comprehensive research.

Implication

There are three impacts in this research, they are as follow:

- a) Economic Impact, with the results of this research, are expected to boost revenue budget expenditure, due to the disclosure of which is transparent and accountable, it is expected, the local revenue both counties and cities will be increased, so that the construction will be evenly we realize.
- b) Environmental impact, with the results of this research are expected to be realized internal and external environmental conditions are conducive and the impact on the welfare of employees and leadership and equal to all people.
- c) Social impact, the financial statements of Good Governance, the government was expected to improve health, education for the poor, places of worship, social for homes and underprivileged society.



REFERENCES

- Afryansyah, Rahmat Dian., 2013,“Faktor-Faktor yang Mempengaruhi Pengungkapan Informasi Akuntansi di Internet oleh Pemerintah Daerah”, *Diponegoro Journal of Accounting*, Vol. 2, No. 3, Tahun 2013,<http://ejournal-s1.undip.ac.id>. Accessed on 3 April 2014 at 11.00 WIB.
- Annisa, Citra., 2011,“Implementasi E-Government Melalui Bursa Kerja Online pada Kementerian Tenaga Kerja dan Transmigrasi”,*E-Journal Universitas Indonesia*,http://data.axmag.com/data/201410/20141018/U127585_F307311/media.pdf. Accessed on 9 March 2015 at 13.40 WIB.
- Arifin, Johan. 2014. Isomorphic Pressures Influencing The Level of Mandatory Disclosure Within Financial Statements of Indonesian Local Governments. Ph.D. Curtin University, School of Accounting. Thesis.
- Garnita, N., 2008, “*Pengaruh Akuntabilitas terhadap Kinerja Instansi Pemerintah Daerah*”, Universitas Widyatama, 2008, *Skripsi*.
- Goechi.com (2010), Satu Langkah Menuju Implementasi e-Government bagi Pemerintah Daerah di Indonesia, Diunduh dari <http://www.goechi.com/webpemda.html>
- Hadi Poernomo, (2013), JAKARTA, kabarbisnis.com: Penyimpangan laporan keuangan pemda dan BUMD capai Rp1,17 triliun Online: Tuesday, 02 April 2013 | 18:14 wib ET
- Hudoyo, Yaceb Triandy., Amir Mahmud., 2014,“Faktor-Faktor yang Mempengaruhi Pengungkapan Laporan Keuangan di Internet oleh Pemerintah Daerah”,*E-Journal Universitas Negeri Semarang*, vol.3, no.4, 2014 <http://journal.unnes.ac.id/sju/index.php/aa/article/view/4210>. Accessed on 8 September 2014 at 16.30 WIB.
- http://id.wikipedia.org/wiki/Situs_web. Accessed on 10 March 2015 at 14.30 WIB.
- Laswad, F., Fisher, R., & Oyelere, P. (2005). Determinants of voluntary internet financial reporting by local government authorities. *Journal of Accounting and Public Policy*
- Medina, Febri., 2012,“Faktor-Faktor yang Mempengaruhi Transparasi Informasi Keuangan pada Situs Resmi Pemda di Indonesia”,*Skripsi Sarjana*, <http://lontar.ui.ac.id>. Accessed on 22 March 2014 at 15.45 WIB.



- Rahadian, A. H., 2008, “*Mewujudkan Good Governance Melalui Pelayanan Publik*”,
- Sari, D., 2013, “Pengaruh Sistem Pengendalian Intern Pemerintah, Implementasi Standar Akuntansi Pemerintahan, Penyelesaian Temuan Audit Terhadap Penerapan Prinsip-Prinsip Tata Kelola Pemerintahan yang Baik”, *Proceding SNA XVI sesi 1*, 2013, hal. 1007.
- Soepriyanto Gatot dan Aristiani Restya (2011), *Evaluasi Pengungkapan Laporan Keuangan Daerah di Situs Internet: Studi Pada Pemerintah Daerah di Indonesia*, *Binus Business Review Vol.2 No.1 Mei 2011:192-201*, Jurusan Akuntansi, Fakultas Ekonomi dan Bisnis, Bina Nusantara University, Jakarta
- Sukyadi, Didi., 2009, “Model Interoperabilitas Sistem Informasi Layanan Publik”, Studi Kasus *E-Government*, *E-Journal Universitas Indonesia*, <http://lib.ui.ac.id/>. Accessed on 10 March 2015 at 13.20 WIB.
- Rahman, Aditya., Sutaryo., Agus, Budiarmanto., 2013, “*Determinan Internet Financial Local Government Reporting di Indonesia*”, *Simposium Nasional Akuntansi XVI*, Manado, 25-28 September 2013
- Sinaga, Yurisca Febrianty., 2011, “Analisis Faktor-Faktor yang Mempengaruhi Pelaporan Keuangan di Internet Secara Sukarela oleh Pemerintah Daerah”, *E-Journal Universitas Diponegoro*, <http://eprints.undip.ac.id/>. Accessed on 26 March 2014 at 14.00 WIB.
- Trisnaningsih, S., 2007, “Independensi Auditor dan Komitmen Organisasi sebagai mediasi Pengaruh Pemahaman Good Governanc, Gaya Kepemimpinan, dan Budaya Organisasi terhadap Kinerja Auditor”, *Proceding SNA X*, 2007.
- Wati, E., Lismawati, Nila, A., 2010, “Pengaruh Independensi, Gaya Kepemimpinan, Komitmen Organisasi, dan Pemahaman *Good Governance* terhadap Kinerja Auditor Pemerintah”, *Proceding SNA XIII*, 2010.
- Xiao, J. Z., Yang, H., & Chow, C. W. (2004). The determinants and characteristics of voluntary internet-based disclosures by listed Chinese companies. *Journal of Accounting and Public Policy*.



MANAGEMENT SUPPORT AND INTERNAL AUDITOR COMPETENCY
MATTER: EMPIRICAL STUDY OF INTERNAL AUDITOR IN INDONESIAN
PUBLIC SECTOR

Titania

Endang Sri Rahayu

Indah Setyasari

M.L. Astri Prehtin Noviana

Universitas Sebelas Maret, Surakarta, Indonesia

aiem.titania@gmail.com

Abstract

The aim of this research is to identified the crucial issues faced by internal auditor in Wonogiri Regency and its impact on the quality of local government financial report. Research methodology used in this study is interview. Interview method can stimulate the respondent to answer the question and dig further the information from respondent. The result of this empirical research shown that there are two factors influenced performance of the internal auditor, namely management support and internal auditor competency. Management support has strong relationship with independency and the tone at the top of the leader commitment. If the internal auditors are not independent, the financial report produced will be biased which in turn is useless to improve the accountability and transparency of the public sector. Tone at the top helps maintaining an effective internal control system, and it indirectly helps in preventing fraud and other unethical behaviors in organization. Auditor competency divided into quality and quantity of internal auditor in Wonogiri Regency. The lack in quantity and quality of internal auditor affect the performance of internal auditor in doing their duty as an auditor which is related to the quality of financial report.

Keywords: Management support, internal auditor competency, Wonogiri Regency, Local government internal auditor, and Quality of local government financial report.

JEL Classifications: H83, M42



INTRODUCTION

Indonesia is one of the countries that adopted decentralized governance system. The implementation of this system has been established since 1999. By adopting decentralized system, local government can improve both quality and quantity of public services, empower and create a space for society to participate in the development process, and create the efficiency and effectiveness in using resources. Decentralized system also challenge local governments in Indonesia to manage their own regions but however it is still controlled by the central government and laws. Transfer or delegation from central government authorities to local government must be accompanied by the allocation of fund needed to execute these powers (Ritonga, Clark et al.). One of the authorities' of local region is conducted fiscal decentralization. Fiscal decentralization is an authority for local government to manage their own finance sourced from higher level government to lower level government. In the concept of local government autonomy, each local government is granted rights to design and manage their own policies to achieve the goals that congruence with the central government's strategic plan. The central government does not provide detailed rules; it only provides principles of managing local finance to local government. As a result, each local government has its own programs and activities based on its own resources. The implementation of those programs and activities is financed through the budget. So, the regency, city, and province since then, are required to publish their financial statements as manifestation of their accountability.

Due to this accountability duty, the role of internal auditor performed by as an *internal watchdog* should be applied optimally. Internal auditor also should maintain the integrity of the local government in order to prevent fraud and misappropriation actions of local government. One of the local governments that will be discussed further in this paper is one of local government in Indonesia, named Wonogiri Regency. Indonesia is a country which located in the continent of Asia. Indonesian territory is composed of 34 provinces. A province is the highest level of the local government divisions of Indonesia. Provinces in Indonesia are further divided into regencies and cities. Wonogiri is regency located in Central Java. Wonogiri Regency is consisting of 25 administrative districts. It is such a lot of districts owned by Regency.



To carry out the tasks, based on article number 48 of Government Regulation Number 60 year 2008, internal auditor has the function to do audit. In Wonogiri Regency, is one of the special one because since audited from the year 2005 till the recent year, Wonogiri still get qualified opinion. Qualified opinion means that the audit was restricted in scope, records do not completely reflect the condition that should be conformed to the rules, there is a material changes (between accounting period), auditor and management are unable to reach compromise agreement regarding treatment of valuation of certain asset (Arens, Elder et al. 2003).

Interview has been taken in order to know the problem faced by internal auditor in Wonogiri Regency. The top problems faced are the commitment of the top leader of Wonogiri Regency and competency of internal auditor (Holil, the internal auditor in Wonogiri Regency, 2015). These two problems, will give the impact on internal auditor performance and finally it can influence the quality of local government financial report. There are some popular issues faced by local government in Indonesia (Suwanda 2015) namely:

1. The problem of corruption, collusion, and nepotism. The local government nowadays is often involved in corruption. Corruption today has involved a lot of people in any levels. Approximately, 300 people, thousands of members of the House of Representatives (DPRD) and thousands of state administration are involved in corruption.
2. Accountability Issues. As what has been mention above, to carry out its activities, the local government requires a lot of funds. Any use of these funds should be recorded, reported in the financial statements as an accountability obligation to the public. Financial report of the local government will be examined by the Supreme Audit Agency at the end of financial year. Local Government Financial Report considered good if they received an unqualified opinion. An unqualified opinion is issued when the independent auditor believes that the local government's financial reports is free from material misstatements. As an internal part in the local government, the internal auditor has its own norm and supervision role in order to implement good governance. Internal auditor has an authority to oversee the



course of the local government practice, so that it can help prevent and detect misappropriation.

3. So, the intents of this paper are to discover and identified problems faced by internal auditor of Wonogiri Regency and its effect on the quality of the local government financial report of Wonogiri Regency.

THEORETICAL BASIS AND REVIEW OF LITERATURE

Theory of stewardship describes a situation where the management is not motivated by the goals of the individual but a common goal for the benefit of the organization (Donaldson and Davis, 1991). In 1957, stewardship approach has been used as an approach for determining the center of gravity of a financial statement. This is based on a concept that the management of a company responsible for the company owner. Stewardship theory is introduced as a theory which discusses human behavior in an organization where leadership is practiced as an aspect that plays an important role in an organization.

Analogy of stewardship theory in this study is described by the Government as an institution that is trusted to be able to act in accordance with the public interest (principal). Local Government as an autonomous region has the authority to manage the affairs of government as well as to provide services to local society. The Government acted as a steward who carry out the mandate that has been entrusted by the public (principal) to manage the resources and assets, as well as to provide good public services for the community. Local Government to act as a steward should be able to carry out their mandate to the public. According Mardiasmo (2002), accountability in the public sector is a steward obligation to disclose all the activities which they are responsible to the principal (society).

A form of accountability that can be given by government to the public is in the form of financial statements. The reliability of those statements reflected by the opinion. The better the opinion, the better accountability of the local government. To perform these functions, the stewards (internal auditor) mobilized all its capabilities to produce qualify financial statements. Abdel-Creator, et al (1983) found in their study that the internal audit function can support a financial statement audit performed by the external auditor. This can improve the quality of the audit and the implications on improving the quality of financial reporting.



Research carried out of Gordon and Smith (1992) concluded that the internal audit function plays a key role in improving the control environment and it can help to avoid irregularities in the financial statements and may ultimately improve the quality of financial reports. Quality internal auditor is usually measured in some indicators, one of which is the internal auditor competence (Noubbigh and Mamoghli, 2013). Novyarni (2014) stated that the competence of the internal auditor affect the quality of financial reporting. The quality of financial reporting will provide value to the local government when internal auditors have competence in carrying out reviews the financial statements.

Competency can defined as the ability of an individual to perform a job properly based on the educational level, professional experience, and the effort of the staffs for his or her continuing professional development (Baharud-din, Shokiyah et al, 2014). Basically, a person's competence consists of knowledge, technical skills and also interpersonal skills (Robbins, Judge et al, 2003). Bernardin (2002) says that the competence meant as a "set of knowledge, skills, or abilities". Competence has a close relationship with the quality of work, like in the audit. In order to obtain a high quality of internal audit, competent internal auditors are needed (Pickett 2005). Lasmahadi (2002) states that competence is a personal aspect of a person that makes the person possible to achieve superior performance. Auditor competence formatively measured by four indicators, namely:

- Planning, where Dikolli, McCracken et al. (2004) states that the audit plan make a good auditor will potentially have a competence to find material misstatements. Audit planning should take into account the client's internal control systems, audits risk, and substantive testing procedures;
- Knowledge, in which Tan and Libby (1997) stated that knowledge is one of the determinants of technical competence and it is very useful in a structured auditor task;
- Experience, where Colbert (1989) states that experienced auditors will make a decision with lower error rate; and



- Supervision, where Malone and Roberts (1996) states that strong supervision would prevent the possibility of the auditors to act with lower quality of audit and audit supervision tend to produce proper disclosure and the quality of audit is higher.

Auditor Competency

Audit competence refers to the ability of auditors to carry out the duties and functions with integrity and transparency. Increasing of auditor competence leads to find errors and irregularities in the financial statements. Competence become key strategies that help auditors perform their duties and functions (Wangraj, Ussahawanitchakit et al. 2014). Competence is expected to increase the auditor's professional attitude. Professional attitude can be a “weapon” in maintaining the credibility of financial information due to public demand to the accounting profession to improve the quality of professional services, especially financial statement audit services. Furthermore, at this time the profession has also been demanding higher professional education program for auditors, auditing, and accounting in order to ensure that they keep abreast of new ideas and techniques in auditing and accounting. Previous study has tested that there is a positive relationship between the competence of personnel in Inspectorate to audit quality in the Inspectorate South Sulawesi Province, if the competence of internal auditor of the Inspectorate is high, the performance of the Inspectorate will have a positive effect on audit quality in Inspectorate, and vice versa if the competence of personnel has a low quality, it will drop the Inspectorate performance (Usman, Sudarma et al.). So, the higher the competence and independence of auditors, the higher the quality of audits produced (Octavia and Widodo, 2015).

Independency

Definition of independence according to Bakar and Ahmad (2009), independence is the primary justification of the existence, and thus the hallmark of the auditing profession. It is recognized as the primary attribute to be maintained by auditors in all circumstances. The basic principle of professional ethics consists of independence, integrity, and objectivity (Rahmina and Agoes, 2014). Professional ethics requirements that have been set should be



respected by the auditor, in breach of this requirement will result in a decrease in the quality of audit objectives that have a direct impact on the audit report (Mironiuc, Chersan et al., 2013). Independence can help reduce the misuse of public funds when examining the public administration. Independence in this case is the manner in which the auditor cannot be affected by or other parties who have a personal interest. According to Salehi, Mansoury et al. (2009) independence is the basic reliability of the auditor's report. The report would not be credible, and investor and creditor would have little confidence in the auditor, if the auditor is not independent both in fact and appearance. The independence of the audit refers to the ability of auditors to act with integrity and impartiality during the audit task. One of study that has been conducted also explained about one of the factors that can enhance the independence of auditors is the risk of penalties for auditors (Akpom and Dimkpah, 2013). The independence of the audit according to Arens, Elder et al (2008) is interpreted as taking an unbiased point of view. Auditor independence is defined as the heart of the integrity of the audit process where maintaining the independent audit function is obligatory for auditors and required by the standards of profession (JIAN, 2012).

Auditor's Performance

The performance of auditors can be defined a comparison of the results of the implementation of the task and the responsibility given by the organization at certain time and can be used in the measurement of relative job. According to Kalbers and Fogarty (1995) performance is measured from the component performance namely that the knowledge, skills and experience are an instrument to maintain the observance of an auditor of the code of ethics and generally accepted auditing standards (Libby, 1995). These instruments are part of an auditor's performance in maintaining the quality of audit result that has been done. It was found that the motivation and personality of a person affects the performance of the individual to do the job. The ability of an auditor in performing their duties is determined by an individual competencies possessed (Ferris 1977; Kanfer, Wolf et al., 2010). The ability of an auditor in performing their duties is determined by an individual competencies possessed. The individual competence include; emotional competence, social competence, and



intellectual competence (Spencer and Spencer, 1993). Tasks and workloads that are too dense can lower a person's effort or motivation (Bonner, Hastie et al., 2000).

Wonogiri has the complexity and workload on average higher than other regency in Surakarta. Wonogiri has a wide area causing the internal auditor's role becomes difficult and the need for greater mobility and quality of human resources employees with high intellectual ability. The existence of a good understanding of their duties and functions as a civil servant who has a duty to carry out prevention and supervision of financial abuse region, therefore, there must be spirit of idealism to the duties and responsibilities, which in turn will lead to a commitment to help preventing misappropriation of local government financial report. Therefore indirectly be said that the competence can give effect to the commitment emergence to the organization.

Management Support

Getie Mihret and Wondim Yismaw (2007), their Ethiopian higher education case study result shows that management support to internal auditor is considered as one of the determinants of internal auditor's attributes. They also indicate that audit findings and recommendations would not serve much purpose unless the management is committed to implement. According to the COSO Internal Control Framework, the control environment component is composed of five principles, among which we can find tone at the top as one of the attributes that characterize the first principle, i.e. "The organization Demonstrates a Commitment to Integrity and Ethical Values". Within the Framework (COSO, 1992), this attribute is referred to as "Tone at the top and throughout the organization".

The phrase *tone at the top* in this study refers to the style of the partner in charge of supervising an audit assignment (Carpenter and Reimers, 2007; Carpenter and Reimers, 2009; Carpenter and Reimers, 2009). According to the Tread way Commission "tone at the top is the most important factor contributing to the integrity of the financial reporting process" (Pincus, Rusbarsky et al., 1990). An organization's tone at the top is primarily determined by the top level management in the organization. Top executives can influence the ethical mindfulness of organizational members in a positive as well as in a negative direction (Thomas, Schermerhorn et al., 2004)



METHOD OF RESEARCH

For the purpose of this study, the main form of data collection was through face to face interviews with the internal auditors in Wonogiri Regency. Wonogiri Regency is chosen because it has the biggest scope area of work in several city located in Central Java, namely Surakarta, Boyolali, Sukoharjo, Wonogiri, Sragen, Karanganyar, and Klaten (Farida, internal auditor in Wonogiri Regency, 2015), which result in the most enormous clients among those territories. Not only that, the opinion of qualified opinion is remaining unchanged from the year 2005 till 2014. Interviews have an advantage of enabling the researcher to establish connection with potential respondents and therefore gain their cooperation. By using interview, also allow the researcher to clarify ambiguous answers from the respondent. Not only that, interviews method can stimulate the respondent to answer the question, dig further the information from respondent, and record the answers. But, if all of these tasks are not carried out properly, the interviews become not qualified.

This research is done through a qualitative analysis which consists of research questions and research objectives. The respondent of the interview are internal auditors Wonogiri Regency who have experience in audit and supervision for about more than 5 years and also have passed the auditor certification exam, so that the respondents are competent enough to answer the entire question. The script in the interview sessions were used as the main findings for this research. The interview sessions were recorded, interpreted, and also analyzed based on the conversation of both interviewers and interviewees.

RESULT AND DISCUSSION

The legal basis of the establishment of internal auditor of Wonogiri Regency has been regulated by law. In order to actualize an orderly financial management, supervision and control is needed. Supervision over the Regional Government is the activity aimed to ensure that the regional administration and the village administration went according to plan and the provisions of the legislation. Supervision is carried out by the Internal auditor in Wonogiri Regency. Internal Audit done by internal auditor in Wonogiri Regency is the whole process of audit activities, review, evaluation, monitoring, and supervisory activities in order to provide reasonable assurance that the activities have been carried out in accordance with the



benchmarks that have been established in realizing good governance. Based on duties above, internal auditor in Wonogiri Regency plays an important role in establishing good and clean governance in Wonogiri Regency. But in the implementation of its activities, there are many obstacles encountered by the internal auditor in the Wonogiri Regency.

Wonogiri Regency has the complexity and workload higher than other regency in Surakarta. Wonogiri has a wide area causing internal audit role becomes difficult and it needs greater mobility, and good quality of human resources. Employees with high intellectual ability, with undergraduate accounting education (corresponding to the ability of an auditor) for example, will be able to understand the duties and functions of internal auditor. Basically, a person's competence consists of knowledge, technical skills and also interpersonal skills (Robbins, Judge et al., 2003). Bernardin (2002) says that the competence meant as a "set of knowledge, skills, or abilities". Competence has a close relationship with the quality of work, like in the audit. In order to obtain a high quality of internal audit, competent internal auditors are needed (Pickett, 2005). The existence of a good understanding of their duties and functions can help preventing misappropriation of local government financial report.

The result of the findings can be summarized as follow:

Table 1. Top Problems Faced by Internal Auditor in Wonogiri Regency

No.	Top Problems	Indicators
1.	Management Support	<ul style="list-style-type: none"> ● Auditor Independency ● Tone at the Top
2.	Internal Auditor Competency	<ul style="list-style-type: none"> ● Educational Background ● Experience ● Training ● Quantity of Auditor Personnel

Source: Primary Data through Interview



Those findings above rose from the results of interviews that have been conducted. There are two main problems faced by the internal auditor in Wonogiri Regency, the first is problem in the management support and the second is competency of existing personnel in the Wonogiri Regency. Management support is closely related to commitments on top management. Management support also related to the issue of independence. As we know, the internal auditors in conducting their duty is submissive under Local Government Leader. The result of audit, review, monitoring, evaluation, and other activities will be reported to the Local Government Leader. The influence of region Local Government leader is very influential and even can intervene in the results of the audit or the review that has been done by the audit team. Internal auditor supposed to be more independent, or stand alone as an independent body from any intervention, so as long as the it is still below the Local Government Leader, then the problem management support will never be solved. If the internal auditors are not independent, the financial report produced will be biased which in turn is useless to improve the accountability and transparency of the public sector (Ahmad, Othman et al., 2009).

According to interviewees, some audit findings or results of the review produced by the audit team often get the intervention from the top management. Not only that, management's commitment to follow up the findings and recommendations are not fully carried out. This resulted in the presence of the findings of the external auditors repeatedly found while conducting the audit. For instance, no wonder that qualified opinion was achieved by Wonogiri Regency unchanged from 2005, and the problems can hamper to obtain unqualified opinion from year to year remains the same, namely the problem of asset. It also indicates that audit findings and recommendations is useless if there is no effort to execute the findings (Mebratu, 2015). Getie and Yismaw (2007), state that management support of internal auditor is considered as one of the determinants of internal auditor's attributes. They also indicate that audit findings and recommendations would not serve much purpose unless the management is committed to implement.

We can conclude that tone at the top play an important role in determining performance of internal auditor and also the quality of local government financial report. It is generally believed that a strong tone at the top helps maintaining an effective internal control



system, and it indirectly helps in preventing fraud and other unethical behaviors at all levels in the organization (COSO, 1992). D'Aquila and Bean (2011) examined the influence of the tone at the top on financial reporting decisions. The authors start from the premises that, despite attempts by organizations to create ethical environments, people in charge with reporting are sometimes confronted with ethical dilemmas that may affect ethical decisions. The results of the study provide evidence on how top management is able to influence organizational culture. Furthermore, the study documented that when employees are placed in a setting where tone at the top that does not foster ethical decisions, they are more likely to choose unethical responses. Overall, the results provide support for the position that tone at the top does relate to financial reporting decisions.

The second crucial issue is about the internal auditor competency. The problem related to quantity and quality of the personnel. First is about quantity, internal auditors in Wonogiri Regency consist of 22 personnel of internal auditors. This total personal is too small compare with the total amount client that should be maintained. Based on information gained from interviewees, every month, Wonogiri Regency must conduct 20 services related to audit, review, and other service. Ideally, one audit team consists of 4 or 5 people, or in another words every month, there are approximately 80 or 100 people involved in audit task. From this information it is clearly that there is lack of personnel of audit team. From this condition, the audit team should minimize the size of audit team personnel or usually, Wonogiri Regency will only provide service to cases that have high level of risk, so not all the cases can be covered by internal auditor. Second problem related to competency, it is about the internal auditor quality. From 22 internal auditors in Wonogiri Regency, only 5 internal auditors get their auditor certification through training and certification exam. The other internal auditors get their certification through inpassing which is much easier than the formal one. The passing grade for inpassing is not as high as the formal one. This condition shows that the competency of internal auditor is unequal, and finally will effect on the quality of audit. Different auditor will generate different audit quality. The condition has not improved since the formation of civil servant candidates for the position of auditor, which is never appropriate. So, based on these empirical findings, both management support and auditor competency is two main problems faced by internal auditor in Wonogiri Regency.



The audit function should needs a professional staff that collectively has the necessary qualifications and also competence to conduct the full range of audits task required by its mandate. These problems both directly and indirectly affect the quality of local government financial report.

CONCLUSION

Since the establishment decentralized governance system, there is an authority for local government to manage their own finance. Internal auditor should maintain the integrity of the local government in order to prevent fraud and misappropriation. But there are some problems faced by internal auditor of Wonogiri Regency, namely management support and internal auditor competency. Based on interview taken, both of these problems have an influence on the quality of local government financial report. Management's commitment to follow up on the findings and recommendations not fully carried out. This resulted in the presence of the findings of the external auditors repeatedly found while conducting the audit. Full support and commitment from top management is vital for internal audit function to meet its full potential and to function effectively (Ahmad, Othman et al. 2009). The second issue is the lack both quality and quantity of internal auditor. Quality or competence of internal auditor is still not appropriate in term of education background and adequacy of training. Uniformity quality of local government financial report will be existed since the competence of internal auditors is not similar. These issues finally impact the quality of local government financial report.

Limitation, this paper relies on single source of information, namely interview. Although there are lots of advantage from interview, but it is better for the next research, to add another research methodology, so that the result can be more comprehensive. This research did not use statistical tools that can measure how strong the influence of two crucial issues faced by internal auditor of Wonogiri Regency on the quality of local government financial report. We also suggest adding sample, so that the result of the research can be used to represent the condition all over Indonesia. Implication of this research is giving overview of the condition of internal auditor in Indonesian public sector. Internal auditor should be more independent, so the central government ought to revise the rule related with internal



auditor. Internal auditor should be under the ministry, so that local government leader will not intervene internal auditors' work.

REFERENCES

- Abdel-Khalik, A.R., Snowball, D. et Wragge, J.H. (1983), "The Effects of Certain Internal Audit Variables on the Planning of External Audit Programs", *The Accounting Review*, Vol. 58, No. 2 (Apr., 1983), pp. 215-227.
- Ahmad, N., R. Othman, et al. (2009). "The effectiveness of internal audit in Malaysian public sector." *Journal of Modern Accounting and Auditing*5(9): 53.
- Akpom, U. N. and Y. O. Dimkpah (2013). "Determinants of auditor independence: A comparison of the perceptions of auditors and non-auditors in Lagos, Nigeria." *Journal of Finance and Accountancy* 14: 1.
- Arens, A. A., R. I. Elder, et al. (2003). *Assurance Services an integrated approach*, Pearson Edification.
- Arens, A. A., R. J. Elder, et al. (2008). "Auditing dan jasa Assurance." *Terjemahan Oleh Hermawan Wibowo*. Jakarta: Erlangga.
- Baharud-din, Z., A. Shokiyah, et al. (2014). "Factors that Contribute to the Effectiveness of Internal Audit in Public Sector." *International Proceedings of Economics Development and Research* 70: 126.
- Bakar, N. B. A. and M. Ahmad (2009). "Auditor Independence: Malaysian Accountant's Perception." *International Journal of Business and Management*4(12): p129.
- Bernardin, H. J. (2002). *Human resource management: An experiential approach*, Irwin Professional Pub.
- Bonner, S. E., R. Hastie, et al. (2000). "A review of the effects of financial incentives on performance in laboratory tasks: Implications for management accounting." *Journal of Management Accounting Research*12(1): 19-64.
- Carpenter, T. and J. Reimers (2007). *Professional skepticism: The effects of tone at the top and individual skepticism on fraud risk assessments and on identified audit procedures*, Working Paper, University of Georgia.



- Carpenter, T. and J. Reimers (2009). The effect of a partner's emphasis on professional skepticism on auditors' fraud judgments. University of Georgia and Rollins College, Working paper.
- Carpenter, T. and J. L. Reimers (2009). "Professional skepticism: the effects of a partner's influence and the presence of fraud on auditors' fraud judgments and actions." Available at SSRN 1068942.
- Colbert, J. L. (1989). "The effect of experience on auditors' judgments." *Journal of Accounting Literature* 8: 137-149.
- COSO, S. (1992). "Internal Control—Integrated Framework." The Committee of Sponsoring Organizations of the Treadway Commission.
- D'Aquila, J. M. and D. F. Bean (2011). "Does a tone at the top that fosters ethical decisions impact financial reporting decisions: An experimental analysis." *International Business & Economics Research Journal (IBER)*2(8).
- Donaldson, L., & Davis, J. H. (1991). Stewardship theory or agency theory: CEO governance and shareholder returns. *Australian Journal of management*, 16(1), 49-64.
- Dikolli, S. S., S. A. McCracken, et al. (2004). "Audit-planning judgments and client-employee compensation contracts." *Behavioral research in accounting*16(1): 45-61.
- Ferris, K. R. (1977). "A test of the expectancy theory of motivation in an accounting environment." *Accounting review*: 605-615.
- Getie Mihret, D. and A. Wondim Yismaw (2007). "Internal audit effectiveness: an Ethiopian public sector case study." *Managerial Auditing Journal*22(5): 470-484.
- Gordon LA, Smith KJ (1992). Postauditing capital expenditures and firm performance. *Account Org Society.*, November, pp. 741-757.
- JIAN, K. S. (2012). An investigation into big 4 auditing companies in Malaysia: factors that affect auditor independence, UNIVERSITI TUNKU ABDUL RAHMAN.
- Kalbers, L. P. and T. J. Fogarty (1995). "Professionalism and its consequences: A study of internal auditors." *Auditing*14(1): 64.
- Kanfer, R., M. B. Wolf, et al. (2010). "Ability and trait complex predictors of academic and job performance: A person–situation approach." *Applied Psychology*59(1): 40-69.



- Kangarlouei, S. J., Jam, B., & Motavassel, M. Independent Auditor Opinion, Corporate Governance and Financial Reporting Quality in Firms Listed in Tehran Stock Exchange.
- Lasmahadi, A. (2002). "Sistem Manajemen SDM Berbasiskan Kompetensi." Jakarta: E-Psikologi.
- Libby, R. (1995). "The role of knowledge and memory in audit judgment." *Judgment and decision-making research in accounting and auditing*1: 176-206.
- Malone, C. F. and R. W. Roberts (1996). "Factors associated with the incidence of reduced audit quality behaviors." *Auditing*15(2): 49.
- Mardiasmo. 2002. Akuntansi Sektor Publik. Andi Yogyakarta, Januari.
- Mebratu, A. A. (2015). "Internal audit function and its challenges in public sector governance: Empirical evidence from Amhara National Regional State, Ethiopia."
- Mironiuc, M., I.-C. Chersan, et al. (2013). "Ethics in Providing Non-Audit Services to Ensure Transparency in Financial Reporting." *Procedia-Social and Behavioral Sciences*81: 474-478.
- Noubbigh, E. and Mamoghli, P. C., Internal Audit Characteristics, Financial Reporting Quality: Tunisian Case, Proceedings of the Second Critical Studies in Accounting and Finance Conference CSAFC. 2013.
- Novyarni, N. (2014). Influence of internal auditor competence and independence on the quality of financial reporting by municipal/provincial government. *International Journal of Economics, Commerce and Management*, 2(10), 1-14.
- Octavia, E. and N. R. Widodo (2015). "The Effect of Competence and Independence Of Auditors on the Audit quality." *Research Journal of Finance and Accounting*6(3): 189-194.
- Pickett, K. S. (2005). "The essential handbook of internal auditing."
- Pincus, K., M. Rusbarsky, et al. (1990). "Voluntary formation of corporate audit committees among NASDAQ firms." *Journal of Accounting and Public Policy*8(4): 239-265.
- Rahmina, L. Y. and S. Agoes (2014). "Influence of Auditor Independence, Audit Tenure, and Audit Fee on Audit Quality of Members of Capital Market Accountant Forum in Indonesia." *Procedia-Social and Behavioral Sciences*164: 324-331.



- Ritonga, I. T., C. Clark, et al. "FACTORS AFFECTING FINANCIAL CONDITION OF LOCAL GOVERNMENT IN INDONESIA."
- Robbins, S. P., T. Judge, et al. (2003). "Essentials of organizational behavior."
- Salehi, M., A. Mansoury, et al. (2009). "Audit independence and expectation gap: Empirical evidences from Iran." *International Journal of Economics and Finance*1(1): p165.
- Spencer, L. M. and S. M. Spencer (1993). "Competence at work." Nueva York: John Wiley and Sons.
- Suwanda, D. (2015). "Factors Affecting Quality of Local Government Financial Statements to Get Unqualified Opinion (WTP) of Audit Board of the Republic of Indonesia (BPK)." *Research Journal of Finance and Accounting*6(4): 139-157.
- Tan, H.-T. and R. Libby (1997). "Tacit managerial versus technical knowledge as determinants of audit expertise in the field." *Journal of Accounting Research*: 97-113.
- Thomas, T., J. R. Schermerhorn, et al. (2004). "Strategic leadership of ethical behavior in business." *The Academy of Management Executive*18(2): 56-66.
- Usman, A., M. Sudarma, et al. "Effect of Competence Factor, Independence and Attitude against Professional Auditor Audit Quality Improve Performance in Inspectorate (Inspectorate Empirical Study in South Sulawesi Province)."
- Wangraj, P., P. Ussahawanitchakit, et al. (2014). "Audit Responsibility Competency and Audit Survival: Evidence from TAX Auditors (TAs) in Thailand." *AU-GSB e-JOURNAL*7(2).
- No, P. P. (60). Tahun 2008 tentang Sistem Pengendalian Intern Pemerintah.



**THE MODERATING EFFECT OF ECONOMIC GROWTH ABILITY OF
FINANCIAL FACTORS ON THE IMPLEMENTATION OF E-GOVERNMENT**

Putro Budi Saksono

Asaprima Putra Karunia

Harry Leo Niko Sinaga

Azab Ayub Momot

Master of Accounting Program, Economic and Business Faculty, Universitas Sebelas Maret
putrobs@student.uns.ac.id

Abstract

This study seeks to obtain the evidence about the ability of economic growth in moderating the influence of financial factors in Indonesian local government e-government implementation level. Using the dependent variable of Indonesia e-government ranking (PeGI) issued by the Ministry of Communication. The independent variable used in this study is Degree of Decentralization ratio (RDD), Local Government Financial Dependency Ratio (RKKD), Ratio of Locally-generated Revenue Effectiveness (PAD), and Economic Growth (GRDP) as a moderating variable. Purposive sampling method are used in this study. This study uses sampling criteria of the PeGI. Those criteria are divided into five dimensions (policy, institutional, infrastructure, applications, and planning). A sample of 220 cities/ municipalities meets with those criteria. The data used in this research are taken from the Realization of the Regional Budget Reports (APBD) and the Central Statistics Agency (BPS) in 2012-2015. Descriptive statistics, classical assumption, and Moderated Regression Analysis (MRA) are used in this research.

The results showed that the Degree of Decentralization Ratio (RDD) and Locally-generated Revenue Effectiveness (PAD) were affecting the e-government implementation. On the other hand, Local Government Financial Dependency Ratio (RKKD) doesn't have an effect on e-government implementation. Economic growth does not affecting the implementation of e-government but moderating influence the degree of Decentralization Ratio (RDD) Locally-generated Revenue Effectiveness (PAD) on the implementation of e-government.



Keywords: *e-government, Degree of Decentralization Ratio, Locally-generated Revenue Effectiveness, Local Government Financial Dependency Ratio, Economic Growth*

JEL Classifications: *M48, H83*

INTRODUCTION

The development of communication and information technologies in Indonesia especially in governmental environment evolve rapidly after the issuance of the Keputusan Presiden No. 6 Tahun 2001 concerning the use and development of technology, communication and information. This regulation transforming the public service sector manages by the government (OECD, 2016). This transformation is marked by the development of electronic-government (e-government) (Susanti, Saedudin, & Witarsyah, 2014).

E-government implementation is some of the way to implement a good governance in governmental environment (Arum & Winarno, 2012). Good governance is an economic resource management for social development that will give benefit to the community. This management process should always be effective, efficient and equal (Loina, 2003).

The used of e-government intended to increase the public service by the government (Sipahutar & Sutaryo, 2016). The form of e-government in public services can be shown as the used of transactional service, public information administration, and public participation in decision making process (Nam, 2014).

E-government will increase governmental openness. This openness means that public can seek for any information regarding resource management process done by the government, thus will make the government more transparent (Mardiasmo, 2004). This transparency is important, because if the government is transparent than public can supervise and make a correction to the government.

E-government is an interesting topic to be studied, because the result from previous studies on e-government topic shows some inconsistent result. A study conducted by (Rora, 2010) show that local government size and Local Government Financial Dependency Ratio significantly affecting financial information disclosure on their website. Contrarily to that result, a study conducted by (Rahman, Sutaryo, & Agus, 2013) show that local government



size, local government type and Local Government Financial Dependency Ratio does not significantly affecting the e-government implementation.

Financial factor like Locally-generated Revenue also shows inconsistent result in their relationship with e-government implementation. Study conducted by (Martani & Liestiani, 2010) find that Locally-generated Revenue will be significantly affecting e-government implementation. On the other hand, result from (Zulkifli & Suhardi, 2010) study show that Locally-generated Revenue won't be affecting e-government implementation.

This research utilize Indonesian e-government ranking (PeGI) issued by the ministry of communication and information as a proxy for e-government implementation. This research also used economic growth level issued by the central statistical bureau as a moderating variable.

LITERATURE REVIEW

E-government Implementation

E-government implementation according to Instruksi Presiden No. 3 Tahun 2003 concerning national policy and strategy on e-government, intended to open a chance on informational access, management and utilization to increase efficiency, effectiveness, transpiration, and accountability of governmental performance. E-government implementation is done by utilize and optimizing the use of information and communication technology on government work process and management.

The use of e-government on governmental institution can be divided into five type of usage, there are: service usefulness, transactional service, public information seeking, public participation, and decision making process (Nam, 2014).

Degree of Decentralization Ratio

Degree of decentralization ratio means the contribution of locally-generated revenue (PAD) on the total of local revenue. If the PAD is high, than the local government ability on decentralization performance will also be high and vice versa. This ratio calculated by dividing the PAD with total of local revenue (Mahmudi, 2007). Implementation of e-



government needs some resource, which needs to be financed using the PAD. It means that if the PAD is low, than local government won't have the ability for implementing e-government (Dewi & Haryanto, 2013).

H1: Degree of Decentralization ratio will positively impact on e-government implementation

Local Government Financial Dependency Ratio

Local Government Financial Dependency Ratio is a degree of contribution on transfer revenue to local government total revenue. A high dependency ratio means that local government will be more dependent to the central government (Mahmudi, 2007). Thus the local government won't have free funding for e-government implementation.

H2: Local Government Financial Dependency Ratio will positively affecting on e-government implementation

Ratio of Locally-generated Revenue Effectiveness

Ratio of Locally-generated Revenue Effectiveness is a ratio that show local government ability to mobilize PAD according to the assigned target. This ratio can be calculated by comparing PAD realization with budgeted PAD. More effective local government will give them enough fund for implementing e-government.

H3: Ratio of Locally-generated Revenue Effectiveness will positively affecting e-government implementation

Economic Growth

Economic growth can be defined as an increase in Gross Domestic Product (GDP) without considering that the growth is bigger or smaller than population growth level (Arsyat, 1999). There are 3 components in economic growth, which is: accumulation in capital that involve a new investment on land, physical equipment or human resource, and population growth (Apriana & Suryanto, 2010). A region with high economic growth will face more accountability request from the community Syle and Tennson (2007) in (Dewi & Haryanto, 2013). Thus the local government will be more concern in implementing e-government.

H4: economic growth will positively affecting e-government implementation



Moderating Effect of Economic Growth

Economic growth can also increase or decrease the effect of Degree of decentralization ratio, Local Government Financial Dependency Ratio, and Ratio of Locally-generated Revenue Effectiveness. Economic growth can be directly related to decentralization ratio. A high economic growth in one region can make that region have high a decentralization ratio, because high economic growth can be tightly related to increasing of the PAD. Thus economic growth can also have some impact on Local Government Financial Dependency Ratio, Ratio of Locally-generated Revenue Effectiveness via its impact on PAD. According to that relation between economic growth and those three variables, it can be said that economic growth will have moderating effect with its relationship with e-government implementation. Thus, another three variables rises from this relationship:

H5: Economic Growth will positively affecting on a relationship between Degree of decentralization ratio and e-government implementation

H6: Economic Growth will positively affecting on a relationship between Local Government Financial Dependency Ratio and e-government implementation

H7: Economic Growth will positively affecting on a relationship between Ratio of Locally-generated Revenue Effectiveness and e-government implementation

RESEARCH METHOD

Dependent variable in this research which is e-government implementation are measured using PeGI from ministry of communication and information of Republic of Indonesia. The four Independent variables in this research, which is Degree of decentralization ratio, Local Government Financial Dependency Ratio, and Ratio of Locally-generated Revenue Effectiveness are taken from budget realization report from municipalities in Indonesia. The independent variable of economic growth which also act as moderating variable are taken from report published by Indonesian Central Statistics Agency or BPS. The data used in this research taken from 220 municipalities in Indonesia between 2012 to 2015.



Table 1. Variable Operational

Variable	Description	Indicator	Measurement	Instrument
Degree of decentralization ratio (X ₁)	RDD	<ul style="list-style-type: none"> ● Generated Revenue ● Locally-Generated 	Ratio	Local Government Budget Realization Report
Local Government Financial Dependency Ratio (X ₂)	RKKD	<ul style="list-style-type: none"> ● Transfer Revenue ● Total Of Local Revenue 	Ratio	Local Government Budget Realization Report
Ratio of Locally-generated Revenue Effectiveness (X ₃)	PAD	<ul style="list-style-type: none"> ● Realization Of Local Revenue ● Budgeted Local Revenue 	Ratio	Local Government Budget Realization Report
Economic Growth (X ₄)	PDRB	<ul style="list-style-type: none"> ● Constant Prices of Gross Domestic Product 	Ratio	Provincial Domestic table Gross Product
Indonesian government ranking (Y)	e- PEGI	<ul style="list-style-type: none"> ● Policy ● Institutional, ● Infrastructure ● Applications ● Planning 	Index	Ministry of Communication Report



This research employ Moderated Regression Analysis (MRA) for hypothesis testing purpose. This kind of testing are used because this research want to look for any interaction between those variables. Moderated Regression Analysis are chosen because there is some interaction or multiplication between at least two of the independent variable in the regression equation (Ghozali, 2006). The regression equation used in this research are:

$$Y = \alpha + \beta_1 X_1 + \beta_2 X_2 + \beta_3 X_3 + \beta_4 X_4 + \beta_5 X_1 X_4 + \beta_6 X_2 X_4 + \beta_7 X_3 X_4 + e$$

Description:

- Y : Indonesian e-government ranking
- X₁ : Degree of decentralization ratio
- X₂ : Local Government Financial Dependency Ratio
- X₃ : Ratio of Locally-generated Revenue Effectiveness
- X₄ : Economic Growth
- α : Constanta
- β : Regression Coefficient
- e : Error

RESULT AND DISCUSSION

Descriptive Statistics

Table 2. Descriptive Statistics

	N	Min	Max	Mean	Std. Deviation
X₁	220	0.01	0.79	0.1208	0.09957
X₂	220	0.02	0.98	0.8468	0.11683
X₃	220	0.10	2.07	1.1731	0.32311
X₄	220	-5.98	9.51	5.4554	1.67531
Y	220	1.01	3.62	1.9050	0.54863



The descriptive statistics analysis shows that highest Indonesian e-government ranking is held by Pekalongan City with e-government implementation value of 3.62, and the lowest score held by Toraja Utara Municipalities with only 1.01. highest Degree of decentralization ratio held by Bandung Municipalities with value of 79%. The lowest Degree of decentralization ratio held by Tambraw Municipalities with only 1% decentralization ratio value.

Highest Local Government Financial Dependency Ratio of 98% held by Maluku Utara Municipalities and the lowest of 2% held by Ciamis Municipalities. Highest Ratio of Locally-generated Revenue Effectiveness of 100% held by Banyuasin Municipalities and the lowest of 10% held by Ciamis Municipalities. As for economic growth variable, the highest scoring municipalities are Buton Utara with economic growth value of 9.51%. The lowest economic growth are Lhokseumawe with value below 0%.

HYPOTHESIS TESTING AND DISCUSSION

Table 3. Hypothesis Testing Result

Symbol	Variable	Beta Coefficient	Coefficient Value	Standard Error	T-value	<i>p</i>
X ₁	RDD	β ₁	11.442	3.929	2.912	0.04
X ₂	RKKD	β ₂	5.286	3.494	1.513	0.132
X ₃	PAD	β ₃	-0.886	0.394	-2.248	0.26
X ₄	PDRB	β ₄	0.778	0.666	1.168	0.244
X ₁ X ₄	MODER	β ₅	-1.494	0.728	-2.054	0.041
	ATING					
X ₂ X ₄	MODER	β ₆	-0.935	0.678	-1.379	0.169
	ATING					
X ₃ X ₄	MODER	β ₇	0.152	0.072	2.112	0.36
	ATING					
R ² =25.7	F=10.536	<i>p</i> =0.000	N=220			
%						

Every variable used in this research are normally distributed, and also pass every classical assumption testing employ in this research. Statistical result shows that the R^2 value of this model is 0.257, it means that independent variable used in this research can explain about 25.7% of the phenomenon. F test value from this model are 10.536 with probability <0.05 . It means that this regression model are fit for hypothesis testing.

First Hypothesis of this research stated that Ratio of Locally-generated Revenue Effectiveness will positively affecting e-government implementation. With β 11.442 and sig0.04 <0.05 , the result show that Ratio of Locally-generated Revenue Effectiveness are indeed affecting e-government implementation. Thus H1 are supported.

Second hypothesis (H2) are rejected with β 5.286 and sig0.132 > 0.05 . H4 of this research also rejected with β 0.778 and sig0.244 > 0.05 . It means that there is no relationship between Local Government Financial Dependency Ratio and economic growth with e-government implementation. On the other hand, Ratio of Locally-generated Revenue Effectiveness are affecting e-government implementation with β 0.886, sig 0.026 < 0.05 , thus H3 are supported.

As for the moderating effect of economic growth, result show that economic growth are moderating the relation between Degree of decentralization ratio, Ratio of Locally-generated Revenue Effectiveness and e-government implementation. Statistical testing result show that sig value of 0.041 and 0.036 for both hypothesis, thus H5 and H7 are supported. These results are consistent with result from (Sugiardi, Rini, & Supadmi, 2014) and (Putu & Dwiranda, 2014). Those research stated that economic growth in a region can attract some investor to invest in those region, which will increase its Locally-generated Revenue. With high Locally-generated Revenue, local government will have some funds for implementing e-government in its services to community.

The statistical result shows no moderating effect of economic growth on the relation between Local Government Financial Dependency Ratio and e-government implementation. With sig 0.169 > 0.05 H6 are rejected. Its means that this research are inconsistent with finding from (Ngurah & Dwirandra, 2014). That research finds that economic growth will affecting budget expenditure allocation in supporting e-government implementation.



CONCLUSION

This study aims to seek for evidence in moderating effect of economic growth on local government financial factors for e-government implementation. The result of this study shows that Degree of decentralization ratio (RDD), Ratio of Locally-generated Revenue Effectiveness (PAD) are affecting e-government implementation. On the other hand, Local Government Financial Dependency Ratio (RKKD) doesn't have any effect on e-government implementation. Economic growth doesn't directly affecting e-government implementation, but have some moderating effect on the relation between RDD and PAD and e-government implementation.

The result of this research implies that policy makers in governmental environment need to optimize the function of e-government to support its community services. Next research should consider in using other variables such as social factors, culture, civil servant resource, and other non-financial factors.

REFERENCES

- Apriana, D & Suryanto, R. (2010). *Analisis Hubungan Antara Belanja Modal, Pendapatan Asli Daerah, Kemandirian Daerah Dan Pertumbuhan Ekonomi Daerah*. Jurnal Akuntansi & Investasi Vol. 11 No. 1.
- Arsyat, L. (1999). *Pengantar Perencanaan Dan Pembangunan Ekonomi Daerah*. Yogyakarta: Bpfe.
- Arum, K. D & Winarno, W. A. (2012). *Implementasi E-Government System Dalam Upaya Peningkatan Clean And Good Governance Di Indonesia*. Jeam Vol Xi No. 1/2012.
- Dewi, A. S., & Haryanto. (2013). *Faktor-Faktor Yang Mempengaruhi Implementasi E-Government (Studi Pada Pemerintah Daerah Tingkat Provinsi Di Indonesia)*. Semarang: Diponegoro Journal Of Accounting.
- Dewi, A. S., & Haryanto. (2013). *Faktor-Faktor Yang Mempengaruhi Implementasi Egovernment Studi Pada Pemerintah Daerah Tingkat Provinsi Di Indonesia*. Diponegoro Journal Of Accounting, Volume 2, Nomor 4.
- Ghozali, I. (2006). *Aplikasi Multivariate Dengan Program Spss*. Semarang : Badan Penerbit Universitas Diponegoro.



- Loina, L. K. (2003). *Indikator Dan Alat Ukur Prinsip Akuntabilitas, Transparansi & Partisipasi*. Sekretariat Good Public Governance. Badan Perencanaan Pembangunan Nasional Jakarta.
- Mahmudi. (2007). *Manajemen Kinerja Sektor Publik*. Yogyakarta: Upp Stim Ykpn.
- Mardiasmo. (2004). *Akuntansi Sektor Publik*. Yogyakarta: Andi.
- Nam, T. (2014). *Determining The Type Of E-Government Use*. *Government Information Quarterly* (31), Pp. 211-220.
- Ngurah, I. P., & Dwirandra. (2014). *Pengaruh Pendapatan Asli Daerah Pada Belanja Modal Dengan Pertumbuhan Ekonomi Sebagai Variabel Pemoderasi*. *E-Jurnal Akuntansi Universitas Udayana* 7.1 (2014):79-92.
- OECD (2016). *Organization For Economic Cooperation And Development Principles Of Corporate Governance*. Paris: OECD Principles.
- Putu, I & Dwiranda. (2014). *Pengaruh Pendapatan Asli Daerah Pada Belanja Modal Dengan Pertumbuhan Ekonomi Sebagai Variabel Moderasi*. *E-Jurnal Akuntansi Universitas Udayana*.
- Sipahutar, I. S & Sutaryo. (2016). *Faktor-Faktor Penentu Implementasi E-Government Pemerintah Daerah Di Indonesia*. *Simposium Nasional Akuntansi Xix*.
- Sugiarthi, Rini, N. P, & Supadmi. (2014). *Pengaruh Pad, Dau, Dan Silpa Dengan Pertumbuhan Ekonomi Sebagai Pemoderasi*. *Jurnal Akuntansi Universitas Udayana* .
- Susanti, A, Saedudin, R & Witarsyah, D. (2014). *Analisa Penerimaan Masyarakat Terhadap Layanan E Government Kabupaten Klaten*. Universitas Telkom.



**INVESTIGATING COMPETITIVE ADVANTAGE OF PT SIANTAR TOP, TBK:
CASE STUDY USING FUNCTIONAL BUSINESS ANALYSIS**

Florentina Blandina Parapaga

Yuni Annisa Dewi

Full Time Students, Master of Management Science Program

renypaga@gmail.com

yuniannisa.dewi@yahoo.com

Popy Rufaidah

Faculty of Economics, and Business, Universitas Padjadjaran

popy.rufaidah@fe.unpad.ac.id

Abstract

The purpose of this paper is to discuss the results of using functional business analysis to investigate the competitive advantage of PT Siantar Top, Tbk is a company engaged in the processed food industry. The company manufactures various kinds of snack foods such as crackers (crackers), noodles (noodle), sweets (candy) and developing new products such as biscuits and wafer products. The paper provides the results of the strengths, weaknesses, opportunities and threats of the company through its practices in marketing, finance, human resources management and operation.

The research use case study method that aims to present information in structured, factual, and accurate information on the object studied. Case study method is used to examine the competitive advantages of the company by investigating several business functions performed by the company.

Based on the analysis regarding the competitive advantages of PT Siantar Top, Tbk, firstly, competitive advantages originate from the superiority PT Siantar Top, Tbk in performing the finance, marketing, human resources and operation. Secondly, competitive advantages of PT Siantar Top, Tbk create added value for a company so that the company has excellent position in the market. From the analysis of the external environment, the company has



several strategic opportunities including the implementation of the Asean Economic Community (AEC) can make PT Siantar Top, tbk have an opportunity to get foreign workers who have the competence and expertise better and competition in product innovation increasingly tight can spur PT Siantar Top, tbk to continue to develop their products in order to survive in the industry.

This study provides managerial impact to the company studied, where the company's pricing strategy is one of the most powerful strategies used by the company. Secondly, product innovation is the company's sources to sustain in the market. The company face several weaknesses such as lack of promotion through print media, electronic media, and social media.

This paper is a case study of PT Siantar Top that displays the results of the analysis of competitive advantage \ companies using business functions performed by the company.

Keyword: *Competitive Advantage and Functional Business Analysis.*

JEL Classification: *L20*

BACKGROUND RESEARCH

Environmental change and development are happening so quickly and dramatically, this is caused by the loss of demographic restrictions or well-known as globalization and also the conversion of the flow of information from conventional media to online media. The impact of these changes results in intense business competition in various industries. This condition demands business to develop a wide range of their resources to reach excellence to be able compete and answer the demands of such changes and ultimately win market which will boost the company's revenue to be able to survive.

A source of competitive advantage can be found in the management capabilities of digging the competence fields of functional competencies, i.e. the company field marketing, development and design of products and production (Porter, 1994; Heene & Sanches, 1997). This competitive advantage will deliver superior value for the company as a whole.

In the framework of the achievement of competitive advantage of the company, the functional competency is a must-have imperative. Skills, abilities and performance marketing, innovation, use of technology and production should be continuously evaluated periodically, as a strategic step to maintain or raise the competitiveness of the company itself.



Therefore, a variety of factors that support the company's competency should constitute authentic excellence that is not easily replicable in order to win the market in various industries, both for producer of finished goods as well as services. This is in line with what has been said by Barney (1991) that sustained excellence is sourced on the resource that is valuable, rare, hard to emulate (authentic) and sustainable.

One of industries that produce goods is food processing in a lightweight packaging industry. This industry is one of the industry's most rigorous competition. This can be seen by the development trend of the industry, more and more businessmen in both large-scale and small scale joining snack processing industry. The company created a variety of competing products so that they can be accepted and win the market. To achieve this, companies need to make efforts to improve the competitiveness of their company. Companies need to define well their unique capabilities that they owned and they depend on as well as define how companies develop their ability in the best possible way in gaining competitive advantage (Levitt,1986).

PT. Siantar Top as one of the perpetrators of the food processing industry with light packaging is aware of the challenges faced on the competition. It can be seen from various efforts of PT. Siantar Top in performing a wide range of strategic decisions and policies that can support the growth of the company. To enhance the growth of the company that in line with the previous opinions before, PT. Siantar Top need to pay attention to the competitiveness of the company, one of the ways that can be taken is to develop capability or competence of the company.

The study tried to find the competence of a competitive advantage, the results of this research is expected could illustrate how the company explores competitive advantage resources primarily to improve the performance of PT. Siantar Top, Tbk.

REVIEW OF THE LITERATURE

According to Popy Rufaidah in his Management Strategy (2014), a company will have competitiveness when the company is capable of creating economic value that is better than its competitors. Therefore companies are expected to explore their competence, maintain or even increase the competitiveness.



Competitive Advantage

Competitive advantage (Porter 1986:162) is the ability of a company to profit economically over the gained profits by being able to market competitors in the same industry. In while Grant (1999:89) defines competitive advantage is when two companies compete (on the same customers and markets) and one company has a competitive advantage over other companies, the company gain occurs when the rate of profit is higher or have the potential to earn higher profits. Competitive advantage (Kotler and Armstrong 2008:322) is an advantage above competitors gained by offering more value to consumers, either through lower prices or by providing more benefits that support more expensive pricing.

Based on the opinion above, it can be concluded that a competitive advantage is a better value that a company has compared to its competitors so that it attracts consumers' attention because they considered it better than other similar companies.

Analysis of Competitive Advantage Based Business Functions

According to Porter (1980), there are three fundamental strategies that can help your organization gain a competitive advantage, such as the primacy of cost (Cost Leadership), differentiation of products (Finding), and focus. Porter named the trio as a general strategy (The Generic Strategies). Advantages cost (Cost Leadership) emphasizes on the development of product standards (in all aspects) and very low unit costs. This product indicates that consumers are relatively easily affected by changes in rates. Product differentiation is a strategy that encourages company to be able to find its own uniqueness in the targeted market. The focus of the strategy used to build competitive advantage in a market segment that is narrower.

Competitive advantage can be done by identifying the strengths and weaknesses of the company on a number of business functions. Popy Rufaidah (2014) said that one way to know the state of the company's internal environment is by analysing the activities of its business functions, such as the functions of marketing, operations, finance, and human resources.

It can help a company to know the strengths and weaknesses of the company so that it can help in decision-making, i.e. company's strategic steps in order to survive in the industry.



The four functions of the business are marketing management, finance, Human Resource and operations. The company's excellence in the marketing function can be done by analyzing the marketing function that has done by the company. Marketing is a social and managerial process where person or organization obtain what they need and want through the creation and exchange of value with others (Kotler and Armstrong, 2008:6). Belch and Belch (2009:8), said that marketing is a function of the organization and the process for the creation, communication and delivery of value to customers and managing customer relationships that provides benefits for the organization and stakeholders. The excellence of marketing can be identified on the ability of the company showing greater marketing result than the amount of its marketing.

The company's excellence in financial functions can be done by analyzing the financial functions that are running. According to Gitman and Zutter (2012) There are three functions of financial activity such as a decision for funding, investing and dividends.

- (1). Financing is the process of planning and analyzing the choice of the most appropriate strategy in the search for funding sources for business activities conducted by the company.
- (2) Investing is the process of drafting the strategy of allocation of funds for investment activities that beneficial so that the process of financing can be fulfilled properly.
- (3). The dividend policy is the decision of paying out a percentage of profits to shareholders.

The company's excellence in the operating functions can be done by analyzing the operations function that has executed. Heizer and Rander (2011) says that operations management is a set of activities that generate value in the form of goods and services by transforming inputs into outputs. As Heizer and Rander, Russel and Taylor (2011) defines operations management as a process of transformation of Inputs (such as materials, machinery, labor, management, and capital is converted into outputs (goods and services). Haizer and Rendering (2011) said that there were ten strategic decisions in Operational Management, such as: (1) design of goods and services: describe what is required by the operating activities in the respective decisions of the management of operations. (2) the management of quality: determines the quality of the customer's expectations and create policies and procedures to identify and achieve the quality. (3) design process and capacity: determine how well goods and services are produced and run against technology, quality



management, Human Resource and specific capital investment that determines the structure of the base cost of the company. (4) the selection of location: location where companies will operate is decided with an assessment of the associated proximity to customers and suppliers while considering about the cost, infrastructure and government rules. (5) design of layout: specify the layout facilities can support the work and streamline the work process.(6) human resources: job design and determine how to recruit, motivate and retain personnel with the talent and skills needed. (7) supply chain management: determine how to integrate the supply chain into corporate strategy including the decisions that determine what is purchased, from whom and in what terms.(8) inventory: determine the decision ordering and inventory provision taking into account the capability of suppliers and production schedule. (9) scheduling: determine and implement a schedule of medium and short time period that effective and efficient either for employees or facilities, while meeting customer demand. (10) maintenance: determining who can be responsible in doing maintenance in order to keep the quality increasing.

The company's excellence in human resource management functions can be performed by analyzing Human Resource function that has executed. According to Gary Dessler (2008) the scope of human resource management is divided into three activities: (1) Procurement, namely, efforts to provide the required labor the companies according to the number and specific expertise. (2) development, namely the process of improving the ability and skills, managerial ability as well as good technical capabilities operational. (3) maintenance, i.e. the process of nurturing a relationship with the employees so that employees feel comfortable and are able to work well in the company.

The identification of competitive advantage on PT. Siantar Top, Tbk is done by analyzing the four functions of a business that the company has done, as well as in comparison with competitors that producing the same products as well as serving the same target market. Based on the analysis, it can be identified based on company business functions of excellence.



METHODS OF ANALYSIS

This research used case studies method. Case study is a method of using real-life case in the field of business. This case study method has a correlation with case studies and research with the discussion. Some of the reasons to use the case study method such as: (1) provide in-depth longitudinal examination of a case; (2) provide a systematic way to look at events, collecting data, and analysis; (3) provide a sharp understanding of why an event happened, and what might be important to look more intensively in the future.

Case studies (Yin 1996) is one of the research methods of social science. In addition to the case studies there are still some other methods such as experiments, surveys, information analysis, and historical documentary. Research case study is one of a superior method to understand the issues that are complex and can add strength to know through the examined object in previous studies (Dooley, 2005, p. 333). In general, case studies is studying a few social unit (such as a company or a division within a company) on the question of the real business as an attempt to determine what factors can make successes and failures in an organization. Notes that can be accompanied by the facts that have been known to the opinions and assumptions that were decided can be performed on specific business issues. A more detailed analysis and discussion on the factors that will lead to a behaviour which will ultimately reflect on success or failure. The relevant data are collected, organized, evaluated and generalized. An example of a case study is looking at how a company's management to handle an actual incident and determine whether the policies formulated accordingly. If not appropriate then it takes the recommendations offer about how things could be done better to increase a company's management. Yin (1996) identified six sources of evidence on a case study, as mentioned in the following documents: (1) the shape of letters, memoranda, agendas, letters administration, newspaper article, or in the form of relevant documents to investigate. In the interest of triangulation of evidence, these documents serve to corroborate evidence from other sources, (2) the archives documents get the service record of the researcher, the Organization's record-keeping, list of names, survey data, and other types of recording, (3) the interview is one of the most important source of information on case studies. There are several forms of interviews: open, focused, and



structured interviews or surveys, (4) direct observation by observing objects that are examined during the case studies.

The case study method used in this research is a case study to examine the case of the company. Company case is the type of case studies where the author is extracting information of a corporation. The presentation of the data is done by analyzing the competitive advantage of companies based on business functions and by analyzing a number of factors faced by the company at the macro-environment. These case studies focus on PT. Siantar Top, Tbk as the company's snack industry. How the development and competition will shows information about the company's ability to keep growing and survive in this industry.

RESULTS AND DISCUSSION

Analysis of the Finance Performance

The financial statements of PT Siantar Top, Tbk has been done using a variety of policies and rules of the recording of financial activity in accordance with the regulations and has been audited by the internal auditors or independent auditors. The company's financial health can be measured by analyzing the financial performance of companies based on liquidity ratios, profitability ratios, as well as solvability. This section shows results of the calculation of financial ratios PT. Siantar Top period of January to December 2014 and 2015.

Table 1. Financial Ratios PT. Siantar Top period of 2014-2015

Ratio	2014	2015
LIQUIDITY RATIO		
Current Ratio	148,42%	157,89%
Quick Acid Ratio	90,94%	104,01%
Cash Ratio	1,70%	1,77%
Cash Turnover Ratio	236,80	259,22
Inventory to Net Working Capital	118,71%	93,07%
LEVERAGE RATIO		
Debt To Asset Ratio	52,03%	47,45%



Debt To Equity Ratio	108,48%	90,28%
Longterm Debt To Equity Ratio	42,43%	35,32%
ACTIVITY RATIO		
Receivable Turnover	20,006	19,697
Inventory Turnover	5,922	6,616
Working Capital Turnover	8,322	7,927
Fixed Asset Turnover	2,517	2,528
Total Asset Turnover	1,277	1,325
PROFITABILITY RATIO		
Gross Profit Margin	18,77%	20,91%
Return On Investment	7,27%	9,67%
Return On Equity	15,16%	18,41%
Earning Per Share	94	142
Net Profit Margin	0,0570	0,0730

Source: Processed by Author (2017)

The liquidity ratio is one of indicators of the ability of PT. Siantar Top, tbk to shape all short-term liabilities by using all assets smoothly. The ratio among others is the Current Ratio, Quick Ratio, Acid and Cash Ratio. All liquidity ratio PT Siantar Top, tbk has increased during the **Current Ratio** in 2014-2015 rose by 6,38%, This ratio has increased because the number of short-term assets owned by the company exceed short-term debt. The ratio indicates that the company's ability in paying off short-term debt is improved. In doing so, its impact is the confidence of creditors is increased as the liquidity of the company is increased as well.

Quick Acid Ratio in 2015 occurred an increasement of 14.37% from 2014. The increase in this ratio is due to an increase in the number of assets even though the company's inventory decline. The ratio shows that the ability of the company's short-term debts without the affected inventory also has increased. So the impact on sustainable growing confidence of the creditor or of the parties providing the loan.



For **Cash ratio**, there was an increase of 4.12% in 2015. It is influenced by an increase in cash and cash equivalents the company is greater than the increase in short-term debt. The ratio indicates the company's ability in repaying short-term debt with the availability of cash owned companies has increased. This ratio indicates the ability of the company to meet short-term obligations. Results from the ratio-ratio can be inferred that the PT Siantar Top, Tbk was able to meet all short-term liabilities by using all current assets.

Next on their **solvency ratio**, that is, to measure the ability of PT Siantar Top, Tbk to satisfy the entire obligation by using asset or equity. The ratio among others is the Debt to Asset Ratio, Debt to Equity Ratio, and Longterm Debt Ratio. For a **debt to asset ratio**, seen that happening decreased from 2014 to 2015 and amounted to 8.8%. This is caused by an increased amount of debt is smaller than the increase in the amount of assets owned by the company. This ratio shows the decrease in loan funds that have been used to increase the assets of the company. Thus, the increase in the company's asset occurs because most financed by capital. It can reduce the risk of the company to settle long-term obligations. **Debt to equity ratio**, seen that there is a decrease of 16.8% in 2014-2015. This is caused by the occurrence of increased corporate debt is smaller than the increase in equity of the company. This ratio shows a comparison between the debt of companies with a capital of the company. The decline in this ratio may indicate that the company has the lower risk against his company's liquidity. **Longterm debt to equity ratio**, seen that there is a decline from the year 2014 of 16.7%. This is caused by the efficiency composition between long-term debt owned company with equity. The decline in this ratio resulted is good for the company because the proportion of the use of the equity capital of the company as a source of increasing more compared with an increase of their longterm debt. It also indicated that the company has the lower risk against his company's liquidity. Thus, the increase in the company's asset occurs because most financed by capital. It can reduce the risk of the company to settle long-term obligations. **Debt to equity ratio**, seen that there is a decrease of 16.8% in 2014-2015. This is caused by the occurrence of increased corporate debt is smaller than the increase in equity of the company. This ratio shows a comparison between the debt of companies with a capital of the company. The decline in this ratio may indicate that the company has the lower risk against his company's liquidity. **Longterm debt to**



equity ratio, seen that there is a decline from the year 2014 of 16.7%. This is caused by the efficient composition between long-term debt owned company with equity. The decline in this ratio result is good for the company because the proportion of the use of the equity capital of the company as a source of increasing more compared with an increase of their long term debt. It also indicated that the company has lower risk against his company's liquidity.

The results of ratio before, it can be concluded that PT Siantar Top, tbk was able to satisfy the entire obligation by using asset or equity.

Profitability ratios illustrate the ability of PT Siantar Top, tbk in use all over the source of funding to get the maximum benefit. The ratio between the other is the Return on Investment Ratio, Return on Equity Ratio, Earning per Share, and Net Profit Margin Ratio. **Return on investment** is seen that happen by 2015 increase by 33%. Increased ROI indicates more and improving the return on business profits over the management of assets-assets conducted by the company. Return on equity is seen that there is an increase in year 2015 amounting at 21.4%. The increase in this ratio indicates that the company is effective in increasing revenue so that the investment made by the shareholder returns greater than the previous year. **Earnings per share** are seen that there is significant improvement by 2015 namely amounting to 50.2%. More significant increases were caused by a rise in earnings in the year 2015. This ratio shows the income that is received by any stock investors the company is getting better.

Net profit margin is seen that happen by 2015 increase 28.1%. More significant increases were caused by increasing the company's profits by 2015 compared to the previous year. This ratio shows that financial performance overall is very good because the company can increase the net profit after tax. From the results it can be concluded that the ratio PT Siantar Top, tbk was able to use the entire source of funds that he had to get the maximum benefit.

Competitive Advantages Analysis

Analysis of the competitive advantage a company can be done by considering a number of factors that originate from the external environment of the company, as the



company's competitors. The company excelled in the competition when you can show better performance compared to its competitors of (Rufaidah 2001). Analysis of the external environment is a very important activity, because it gives the direction for the company in generating competitive advantage. According to Porter (1980), there are three cornerstone of strategies that can help your organization gain a competitive advantage, namely the primacy of cost (Cost Leadership), Differentiation of products (Finding), and focus. Porter named the three of them as a general strategy (The Generic Strategies). Advantages cost (Cost Leadership) emphasizes on the development of product standards (in all aspects) per unit cost is very low. This product indicated to consumers relatively easily affected by changes in the price. Product differentiation is a strategy that encourages companies to able to find its own uniqueness in the market so the goal. The focus of the strategy used to build competitive advantage in a market segment that is more limited.

PEST

PEST analysis is an analysis of the external forces that can affect the business processes being run by the company. The external factors include the political, economic, social and technological. By recognizing and analyzing the external environment through pest analysis then will give directions for the company in generating competitive advantage this is in accordance with the opinion of Popy Rufaidah delivered earlier. Following is the result of pest analysis at PT. Siantar top, Tbk.

Politic

Political influence in the business world provides a huge impact because with regulation that created the Government will be affecting the company steps in conducting its business activities. On factors that influence the regulatory entities, among others:(1) PT. Siantar Top, tbk has implement Indonesian of Republic law No. 7 of 1996 On Food to fulfill its obligations to protect the rights of consumers in the process of making its products. This can enhance consumer confidence regarding the quality of the product PT Siantar Top, tbk. (2) the company has been complying with the regulations of the Chief Agency of drug and food of the Republic of Indonesia No. 4 by 2014 About maximum limit the use of food



additives sweeteners. This can enhance consumer confidence regarding the safety of nutritional products of PT Siantar Top, Tbk. (3) the Government of the Republic of Indonesia No. 2015 About Waging 78, PT. Siantar Top, Tbk are unable to suppress labor costs to reduce the cost of production. (4) a determination of the Minister of Trade Regulation No. 22 2016 article 19 prohibition against manufacturers of large and medium-sized businesses to distribute the goods to the retailer will make PT Siantar Top, distribution network and added Tbk resulting in prices at the consumer level will increase.

(5) The Anti-Dumping import policies (BMAD) to import wheat flour is not implemented yet. This can cause PT Siantar Top, Tbk. lost in the competition because of the cost of the raw materials of PT Siantar Top, Tbk will be higher compared to competitors who import raw materials. The imposition of BMAD (Anti-Dumping import policies) can be made if the export price of an imported goods valued at less than the price that aims to prevent the threat of serious losses which may be suffered by the domestic industry

Economy

Based on factors that affect entities, among others; the inflation rate was still high lead to the high exchange rate of the rupiah against the American dollar so that this will have an impact on the high cost of raw material providers either routine and the enactment of the economic community of Asia makes the PT Siantar Top, Tbk has the opportunity to obtain foreign labor who have the competence and expertise.

Social

Food companies in acquiring the opportunities and threats that arise from the change of variable social, cultural and environmental. Trend this change creates the type of consumers and the needs of a varied one with another. Community lifestyle changes become a consumerist society become opportunities for PT Siantar Top, Tbk. because the public will be more likely to spend money on them to meet the needs beyond their basic necessities. Besides the instant lifestyle trend would provide benefits for the company as more and more people are buying packed in packaging. An increase in the population in Indonesia from year to year make the market gets bigger so that opportunities to benefit would be increased. But



that should be noted by the company that in this modern era, the level of one's lifestyle is determined by what is being consumed. Therefore, it is becoming a threat to the company because the products in the production of the company is not a product that belongs to the premium (for middle-level down). Then, more consumers are turning to consume foods that are more expensive just because it wants to be seen higher levels of her lifestyle.

Technology

Rapidly technological developments resulted in the company as a business person should be able to follow and take advantage of advances in technology. Recently PT. Siantar Top, Tbk investing by doing procurement production machine with the finest classification on food production who came from Japan and Korea. In addition the company also leverages an online media either by having a web company can provide a variety of information to stakeholders. Research and Development also continued to develop the latest products this is in line with the company's tag line "High Taste Specialist",

Based on that PEST analysis, obtained summary of opportunity component and threat as shown on table below, well known as External Strategies Factor Summary (EFAS):

Table 2. EFAS of PT. Siantar Top, Tbk

	External Strategy Factors	Weight	Rating	Score	Remark
Opportunity					
1	PT Siantar Top, tbk has applied Indonesian law No. 7 year 1996 about packaging policies related to food safety.	0.05	2	0.1	By obeying the law as set by government, it can increase consumers' trust towards PT Siantar Top, tbk.
2	Enforcement of Economic ASEAN Community	0.15	4	0.6	This opens opportunity for PT Siantar Top, tbk to obtain expatriate labor with better skill and competency.
3	Change of society's life style into consumptive style	0.05	2	0.1	This opens opportunity for PT Siantar Top, tbk, since society spends more money for shopping or purchasing activity.
4	Life style changes into an instant life style	0.1	3	0.3	This opens opportunity for PT Siantar Top, tbk since society will tend to spend more money to buy packaged food.

5	Tighter competition on product innovation	0.1	3	0.3	This encourages PT Siantar Top, Tbk to keep innovating to develop its product to be able to survive in the competition.
Total Opportunity		0.45		1.4	

	External Strategy Factors	Weight	Rating	Score	Remark
Threat					
1	Policy of Ministry of Trade No. 22 year 2016 clause 19 about prohibition of big and middle scale producers to distribute goods to distributor	0.15	4	0.6	This become big threat for PT Siantar Top, Tbk since this will results in higher retail price for consumers.
2	Anti-Dumping Import Duty for importing wheat flour is not implemented yet	0.15		0	This become big threat for PT Siantar Top, Tbk since this can make PT Siantar Top, lose in the competition.
3	Implementation of Economic ASEAN Community	0.15	4	0.6	This is a threat because this tighten food industry competition
4	Increasing rate of unemployment	0.05	2	0.1	Increase of unemployment rate will results in lower purchasing ability
5	Society life style level	0.05	2	0.1	A lot of costumers like to buy more expensive products to obtain pride of higher life style.
Total Threat		0.55		1.4	
TOTAL SCORE		1		2.8	

Source: analyzed by author (2017)

Internal Environment Analysis

PT. Siantar Top, Tbk has an internal environment that supports those companies can operate and achieve company goals. It can be seen from the description of the scope of the internal environment through the presentation of annual report company profile are issued each year. Internal environment analysis is done through functions of business activity or resource based approach. In accordance with the opinion of Popy Rufaidah (2014:70) that the company's internal environment analysis will bring up the components of the strength or weakness of the component companies. Analysis of competitive advantage based on business functions in this study will show the company's competitive advantage is based on the functions of marketing, financial functions, functions, operations and Human Resources functions at PT. Siantar Top, Tbk.

Marketing

The company has a competitive advantage in the marketing function is based on the elements of the marketing mix that consisted of product, price, place, promotion, people, process, and physical evidence. (1) products: components of determining competitive advantage product Siantar Top are from the company's ability to diversify the product pretty much for every type. The results of the analysis of the product mix being done the company based on the depth and width of the product shown on the following table.

Table 3. Mix Product PT. Siantar Top, Tbk

		← Width Product →			
		Chips	Noodle	Biscuit & Wafer	Candy
↑ D e p t h p r o d u c t ↓	French Fries (3)	Spix soba (5)	Goriorio (4)	Dr. Milk (2)	
	Mister Kentang Goreng	Spix Mie Goreng (2)	Goriorio magic		
	Mister Potato (2)	Spix Fujimie (3)	Goriorio super biscuit		
	Mister Bebeto	Suki	Go! Malkist (2)		
	Mister Keren (3)	Gemez (2)	Go! Potato (4)		
	Mister Pop (2)	Gemez Enak (2)	Go! Jumbo coklat		
	Leonet Tator (2)				
	Leonet Keripik Kentang (4)				
	Leonet tictic (2)				
	Leonet vtos (2)				
	Opotatota (2)				
	Twistko (3)				
	Twistball				
	Ketagi				

Description: () Number of Variants,

Source: processed by researchers (2017)

In addition to succeed with a verified product strategy, the company also performs duplication (observing, imitating, developing) against products that have received community such as oreo, duplicate goriorio duplicate leonet leo snack and others. While a component of his weakness among others; the existence of too many product variants make some



consumers will be confused and will tend to choose products that possess a strong image. Other components into the weakness that is the product of excessive duplication will give a negative image to the company because it is considered less in the process of product R & D companies.

The company's competitive advantage in the product prices set function is the ability of companies to apply the strategy of product prices are relatively affordable. Another competitive advantage of a number of elements of the marketing mix is on the component: Place, i.e. the company managed to build a distribution network throughout Indonesia and currently also have successfully entered overseas markets with the same strategy. For transporting its products to the community the company also built a spacious work area by setting up branch offices and factories in some areas/regions such as Jakarta, Medan and Makassar. The company's competitive advantage on promotional functions where companies use a product brochure to the entire distribution network. The company doing the promotion also uses an interesting advertising media advertising but to introduce the new products the company is still less known by the public and it is rated as a component of the company's weakness at this stage of the promotion.

Finance

The company's strategic force based on financial functions, namely: (1) **Obtaining Fund**. On the component power obtaining of the fund, in the year 2015 PT Siantar Top are just getting funding in the form of long-term debts obtained from Indonesia Eximbank, PT Bank Mandiri Tbk, and PT Bank Central Asia Tbk, thus reducing the business risks and there is no change in the ownership of (control) of the company. The company also does not issue shares for control of the company so that funding activities are partly still controlled by the companies themselves (not reduced). In addition, earnings per share the company earned did not decline. While the weakness on the component has not been found. (2) **Allocating Fund**. On the components of strength, companies make an investment that ensure the entire fixed assets and inventories against catastrophic fire and other risks amount around Rp 158,450,000,000, so as to reduce the risk of the company's business. While the weakness of its components found that companies are not investing in the purchase of assets or shares.



This resulted in the company did not get the addition of revenue from the investment of such results, interest, royalties, rental income, and dividend distribution, (3) **Operation (Dividend Policy)**. On the component power operation (dividend policy), the years 2010 to 2015 the company decided to take down the company's earnings as profit being held to strengthen the company's capital. However, with the policy of the company cannot provide the satisfaction of the shareholder for not doing the Division of dividend and this may be a component that undercut the company.

Operation

The company has a competitive advantage in the operating functions are based on the following aspects: (1) Design of goods: the development of a variant of the product is done continually adjusted market interest; development of design packaging products that are tailored to the market within and outside the country. (2) The Managing Quality: the making of products PT. Siantar Top are based on international ISO 9001 production standards and ISO 2200. (3) Process and capacity: on the process and capacity there are components that become the power company has a large production capacity in different factories owned. 4) Location selection: the company has several factories in the country close to the supplier of raw materials and close to the community as a source of labour. (5) Human resources and Job design: the company has put its employees in accordance with the qualification owned and have determined the standard clear employees work for every type of job. However, for certain positions in the recruitment company sets high qualifications in order to obtain energy professional, this resulted in the company will be quite difficult to find workers at some particular position. (6) Supply Chain Management (SCM): the company has managed to integrate the needs of raw materials, production processes, warehousing and distribution channels, it is rated as a component of the company's strength while weakness for components not found in the SCM.

Human Resource Management

The company has a competitive advantage on the function of human resource management based on the following aspects: (1) Procurement (Human Resource Planning,



recruitment, selection, placement, and orientation), namely: the company provides information for people who are interested in want to be employees through an announcement online which is available in the website of the company.

The website provides information about the type of work required and the credentials. While the weak component not found. The company also did a walk interview to trawl the superior labor. (2) Development (training development and career development), namely: excellence in company include employees in various trainings or seminars held by private parties or agencies-agencies in the country, the company provides training for employees to increase their knowledge in the field of technological development and The company bring in experts from outside the country for the transfer of science to improve the competence of the Board of Directors. (3) Maintenance (compensation, integration, and relations with the labour union, evaluation), the company was able to maintain his employees with a number of programs.

Based on that business function analysis, it can be obtained the strength and weakness summary as shown on table 3 below, or known as Internal Strategies Factor Summary (IFAS):

Table 4. IFAS of PT. Siantar Top, Tbk

	Internal Strategies Factors	Weight	Rating	Score	Remark
<u>Strength</u>					
1	Duplication of some products that well-accepted by society	0.1	3	0.3	Producing similar products with lower price than the competitors is expected helps to obtain competitors' market/consumers.
2	Competitive product price	0.05	2	0.1	Competitive price maintains company's position on its market
3	Location of PT. Siantar Top office is quite wide and located in Surabaya, Bekasi, Medan and Makassar	0.1	3	0.3	Company's location which is on big cities has a lot of advantages such as enhance easiness to distribute the products.
4	PT Siantar Top only obtaining long term credits funding.	0.05	1	0.05	Funding through long term credit decreases business risks and there's no changes on business ownership



5	Development of product variance is continuously done and adjusted with target market interest as well as product packaging development that is adjusted with national and international market.	0.1	3	0.3	Development of product variety will diminish customer's boredom.
6	Has factory that located nearby with human resources	0.05	2	0.1	Enhance easiness to obtain employee
7	Company provides training for employee to improve knowledge in technology development	0.05	2	0.1	Company can obtain employee with better skill.
8	Company bring foreigner experts to transfer knowledge to improve director competency	0.1	3	0.3	Company has updated information and learning through experienced expatriate expert
Total Strength		0.6		1.55	

Internal Strategies Factors		Weight	Rating	Score	Remark
Weakness					
1	Promotion is low, especially in introducing new products	0.05	2	0.1	Promotion is important thing for the company to make their product well known by costumers.
2	Lack of promotion in printed, electronic and social media	0.1	3	0.3	Various media can be promotion tools and it is supposed to be maximally utilized.
3	Product duplication can ruin company's image become not creative company.	0.1	3	0.3	The first company that produces a product obtain customer's attention earlier and possible to dominate the market.
4	Company doesn't invest on buying assets or stock.	0.1	3	0.3	This affects by company doesn't get additional income from the investment, such as interest, royalty, rent payment, dividend payout, etc.
5	Company can't give satisfaction to the shareholder for not giving dividend payout.	0.05	2	0.1	If company doesn't give dividend payout, the shareholder satisfaction will be decreased..
Total Weakness		0.4		1.1	
TOTAL SCORE		1		2.65	

Source: analyzed by author (2017).

CONCLUSION



This research was compiled as an attempt to identify competitive advantage through business functions analysis of PT. Siantar Top that are served in IFAS (Internal Factor Analysis Summary) table and identify the external factors which is provided in IFAS (Internal Factor Analysis Summary) table as well.

Competitive advantage is formed based on the ability of the company has made in a number of business activity on the functions of marketing, finance, operations and human resource management that are different from its competitors. Research results showed the competitive advantage at PT. Siantar Top, Tbk based on four areas of excellence marketing, finance, operations and finance. Competitive advantage in the field of marketing, showed that PT. Siantar Top has an excellent product development that seen from a number of product variants created; the extent of the distribution channels which are used in order to distribute the product in the target market as well as the ability of the companies setting the price of the product in accordance with the capabilities of the company. The company's financial functions became one of the company's competitive advantage, as seen from the function of the company profit has sufficiently funds to develop its business, it can be seen well from both the capital structure owned or a high trust factor to the company from the banks as providers of capital. Subsequent Operations on the function of competitive advantage is the ability of PT. Siantar Top has a good food processing plant, distributor of finished products, production management, as well as warehousing system and the use of appropriate operation management. Competitive advantage in the field of HRM Function is the ability of the company in obtaining and developing its employees on appropriate standards and criteria that are clear to any existing office function inside. PT Siantar Top, Tbk has the strategic power based on product price, competitive product innovations that continuously performed, as well as the location of the factory and office of PT Siantar Top, Tbk that is located in Bekasi, Medan, Surabaya, and Makassar. However, from a number of competitive advantage, the company has a number of weaknesses such as the lack of promotion the company through printed media, electronic media, and social media to promote various company's products. The company has several strategic opportunities including the establishment of the Asean economic community that can make the PT Siantar Top, Tbk has the opportunity to obtain foreign labor who have the competence and expertise of a better and more competitive



product innovation to develop their products to survive in the industry. On a threat side, the company is facing problem because Anti-Dumping import policies to import wheat flour has not implemented yet which could lead to the company being outdone in competition. The enactment of the MEA also can be a threat in the competition because of the food industry are increasingly stringent, because the PT Siantar Top, Tbk did not just compete with firms in the country, but will also compete with foreign companies.

REFERENCES

- ,2014. Annual Report of PT. Siantar Top,Tbk. Pp. 100 (<http://www.idx.co.id>)
- ,2015. Annual Report of PT. Siantar Top,Tbk. Pp. 100 (<http://www.idx.co.id>)
- Barney, JB. 1991. *Firm Resources and sustained Competitive of Advantage*. Journal Of Management. Volume 17, Pp. 99-120
- Belch, George E., Belch, Michael A. 2009. *Advertising and Promotion : An Integrated Marketing Communication Perspective*. 8th Edition. McGraw-Hill. New York.
- Dessler, G. 2008. *Human Resouce Management*. 11th Edition. Pearson International Edition. New Jersey.
- Doley, L. M. 2005. *Case Study Research and Theory Building : Advance in Developing Human Resources*. Pp. 335-354
- Gitman, L.J. & Zutter, C.J. 2012. *Principle of Managerial Finance*. 13th Edition. Pearson International Edition. Global Edition. New Jersey.
- Grant R. M., 1999, *Analisis Strategi Kontemporer, Konsep, Teknik, Aplikasi*. Edisi ke 2. Erlangga. Jakarta.
- Heene & Sanches, 1997. *Competence-based Strategic Management*. John Wiley & Sons. New York.
- Heizer, J and Render, B. 2011. *Operation Management, 10th Edition*. Upper Saddle River,Global Edition. Pearson Prentice Hall. New Jersey
- Levitt, Theodore.1986. *The Marketing Imagination*. Free Press. New York.
- Kotler, P and Armstrong, G. 2008. *Prinsip-prinsip pemasaran*. Jilid 1. Edisi Kedua belas. Erlangga. Jakarta
- Porter, M.E., 1986, *Competitive Advantage*, The Free Press, New York.



- Porter, M.E. 1980. *Competitive: Techniques for Analyzing Industries and Competitors*. The Free Press. New York.
- Porter, M.E.,1994; *Keunggulan bersaing*. Binarupa Aksara. Jakarta
- Rufaidah, P. 2014. *Manajemen Strategik*. Edisi Pertama Cetakan Ketiga. Humaniora. Bandung
- Russel, R. S. and Taylor, B. W. 2011. *Operation Management: Along the Supply Chain*. 7th Edition. John Wiley & Sons. New Jersey.
- Ward J. & Preppard J.2002. *Strategic Planning for Information systems*. John Wiley & Sons. Great Britain.
- Yin, Robert K. 2009. *Studi Kasus : Desain dan Metode*. Bumi Aksara. Jakarta.



**BUSINESS PERFORMANCE ANALYSIS OF PT MAS MURNI INDONESIA, TBK:
CASE STUDY USING FUNCTIONAL BUSINESS ANALYSIS**

Muhammad Refki Novesar

Ekky Hasbi Zulkarnain

Master of Management Science Program, Universitas Padjadjaran

refki.novesar@yahoo.com

ekkyhasbi@gmail.com

Popy Rufaidah

Faculty of Economics and Business, Universitas Padjadjaran

popy.rufaidah@fe.unpad.ac.id

Abstract

The purpose of this paper is to present the results analyzing the business performance of PT MAS MURNI INDONESIA, tbk (MAMI) which engage in Property Company that focuses on the construction of shopping centers, apartments and hotels in Surabaya City. Mami is known as a company that introduces unique theater which combine cinemas, shopping centers and apartments in Surabaya. The paper provides the results of business performance analysis of the company by investigating the strategic strengths and weaknesses of the company in term of its practices in marketing, finance, human resources management and operation.

The research used case study method which aimed to present information in structured, factual, and accurate information on the object studied. Case study method was used to examine the performance of the company's business based on the strengths and the weaknesses of the company; and to identify the opportunities and the threats that would be likely faced by the company.

The findings of this study was to show the company's business performance based on financial ratios and other business performance in the sector of marketing, human resource management and operations of the company. This paper also showed the analysis result of



the strengths and the weaknesses of companies based on business functions and displayed the results in table ifas, sfas efas and as a basis for designing programs run by the company.

This study provided managerial impact to the company studied, namely: (1) the financial ratio analysis showed the drop in financial ratios over the previous year. The company is not optimal in the sale and in the use of funding. (2) Marketing performance showed the focus on building customer loyalty; (3) the performance of the company's human resources showed the company is recruiting and developing human resources. (4) Operation management performance showed that the company produces attractive products which are offered in the market.

This paper presented a case study of PT MAS MURNI INDONESIA, Tbk, which contained the analysis results of the companies' business performance based on financial ratios, value chain analysis and analysis of business functions.

Keyword: *business performance, swot analysis, and functional business analysis.*

JEL Classification: L25

RESEARCH BACKGROUND

Nowadays, the level of industrial competition is getting crucial. The industry development is caused by technology's and competitors advancement on economic sector in Indonesia. The development affects the competition of industry and demands the company to provide the best service to the customers. The fiercer competition opens up opportunity for customers to have many choices in selecting providers and certainly, those who benefit them will be the primary choice. That is why the property company competes in providing the best service to satisfy the customers. Fandy Tjiptono,2009

It challenges the company to perform something new so that they can take the lead in the competition, furthermore to answer the government's challenges in ASEAN Economic Community (AEC). The global economic system is the system without borders where the business environment has been growing and changing rapidly. Therefore, the company is demanded to fulfill and to satisfy the customers' desire so that marketed products can have *brand image* which later sticks in the customer's mind. Azhar Susanto (2004)



The management of business performance (MBP) according to (Eckerson, 2006) is a top-down approach that helps the executive to comprehend the process required to accomplish the strategic purpose and then measures the effectiveness of the process in achieving the result. The *management business performance* is a holistic management approach to increase the business effectiveness and efficiency along with an attempt to gain innovation, flexibility, and integration by utilizing technology. *MBP* has a feature in achieving the company strategy by measuring the company process. It can be summed up that *MBP* collects the processes that help the company optimizing the business performance to ensure the company goal is accomplished.

PT MAS MURNI INDONESIA Tbk is one of the companies which engage in property industry which was established on July 27, 1970, in Surabaya. It is also one of the oldest companies that should increase the marketing system in order to be more effective in escalating the company performance.

From the above description of the problem formulation of the study, there should be a study to analyze the Business Performance of PT Mas Murni Indonesia, Tbk through Case Study using Functional Business Analysis, and PT Mas Murni Indonesia is one of the oldest companies in Surabaya. Having so many experiences about business which would be benefited for the industry analyzed. This paper is organized as follows: Section 1 contains the profile of the company based on financial performance. Section 2 presents the reason for using case study method and the research design, the criteria used to interpret the findings of the results. Section 3 discusses the findings of the study. The paper concludes the results of the study in Section 4.

LITERATURE REVIEW

Business Performance

The business performance according to (Eckerson, 2006) is a top-down approach that helps the executive to comprehend the process required to accomplish the strategic purpose and then measures the effectiveness of the process in achieving the result. It can be summed up that *MBP* collects the processes that help the company optimizing the business



performance to ensure the company goal is accomplished. The theory of business performance (Eckerson, 2006) is selected on purpose by the researcher on this paper due to the steps that are used in this theory supporting the researcher in analyzing the business performance of PT Mas Murni Indonesia Tbk.

The business performance analysis based on financial is performed to shorten the measuring financial as the effect of the selected activities (Rufaidah, 2014). The business performance analysis in second internal is the function of financial management which consists of the decision for financing, investing, and dividend (Gitman & Zutter, 2012). The particular aim of financing relates to the benefit achievement such as operation income, working capital, economic value performance, velocity of financial growth or the increase of cash flow. In addition, the analysis of marketing-based business performance is to measure the practice that is performed by the company in marketing (Rufaidah, 2014). Internal environment analysis is aimed to discover the strength and weakness on the functions of the company business. *American Marketing Association* defines the marketing as the institution's activity and process to build, to communicate, to deliver, and trade the offers that value to the customer, client, partner, and people (Kotler & Keller: 2012:27). The business performance analysis based on operation is to analyze the performance of operation management function (Rufaidah, 2014). The third business performance analysis is performed in the function of operation management. The operation management is an activity to create the value in the form of service and product by transforming input into output (Heizer & Render; 2011:36, 39).

The business performance analysis from the human resource management performance is to pay attention to the activity of human resources management (Rufaidah, 2014). The fourth of business performance analysis is performed in the function of human resources management which consist of procuring, developing, and maintaining the workers (Dessler, 2008), this analysis functions to find the strength and the weakness in the human resources management such as procurement that is, position analyzing, staff planning, recruiting, inspecting, selecting, and interviewing. The development is to training and developing the staff, management performance, assessment and career management.



Maintenance is to arrange the payment plan, finance and performance intensive, benefit, service, security, and employee's health and management of global issue of human resources.

RESEARCH METHODS

One of descriptive qualitative study types is case study method or approach. The case study includes the descriptive analysis, which is research that focuses on a particular case to be observed and carefully analyzed. According to Arikunto (1986) argued that "the case study method as one of a descriptive approach, is that the research conducted intensively, detail, and depth to an individual, institution or certain symptom with the narrow area or the subject ". Ary, Jacobs, and Razavieh (1985) explain that in the case study, the researcher tries to find all the important variables. Based on the limitation, it can be concluded that the limitation of case study includes (1) research target can be either human, event, setting, or document; (2) these objects are explored deeply as a totality in accordance with background or respective context with intent to comprehend the linkages between the variables.

The following steps in the case study include: (1) the selection of cases: the case should be selected by purpose and not randomly. The case can be chosen by the researcher by taking the object of human, environment, program, process, and community or social unit. The measurement and complexity of the object have to make sense, so it can be completed by the deadline and the resources available. (2) Data collection: There are several techniques in collecting data, but the technique that is frequently used in case study is observation, interview, and documentation analysis. The researcher as a research instrument can adjust the data with the issue and research environment and can also collect different data simultaneously. (3) Data analysis: Data is gathered after the researcher begins to aggregate, organize, and classify the data into units that can be managed. Aggregation is the process of abstracting the specific things to become common things in order to find a common pattern data. Data can be organized chronologically, or put in a category typology. Data analysis is performed by the researcher in the field, during the data collection or after all the data is collected and completed in the field. (4) Refinement: although all the data has been collected, in the case study approach, there should be refinement or reinforcement of new data on the categories that have been found. New data collection requires the researcher to return to the



field and might have to create a new category, the new data cannot be grouped into categories that already exist. (5) The report should be written communicatively, easily to read, and it should describe a phenomenon or social unit clearly, and also allow the reader to comprehend the important information. The report is expected to bring the reader into the situation of a person or group life case.

Data Collection Technique

(1) **Literature Study:** This method is performed by searching, reading and collecting data through documents - documents such as annual reports of PT MAS MURNI INDONESIA, Tbk, books related to strategic management, and literature - literature related to the issues discussed. (2) **Browsing:** The aim of data collection or information by searching the data - the data or information - information that is related to the materials needed to support the research. (3) **Data analysis:** Data analysis technique is to use swot analysis. SWOT stands for *strength* (the strength of the company), *weakness* (the weakness of the company), *opportunity* (business opportunity), and *threat* (barriers to achieving the goal).

RESEARCH RESULTS AND DISCUSSION

Strategic Posture of the Company

PT MAS MURNI INDONESIA, Tbk engage in the property industry, currently there are two business properties held by the Company HOTEL business, business apartments and shopping centers. There are two enterprises ruled by the company. They are located in Surabaya. The hotel business is the primary business of the company. In the hotel sector, the company runs the Garden Palace Hotel, a four stars hotel, an international class which is: *Standard Room, Superior Room, Deluxe Theme, Club Royale, Club Royale Suite, Ministry Suite and Sultan Suite*. As an international hotel, the garden palace hotel is facilitated by *food & beverages* which are: Ming court Chinese Restaurant, Nishiki Shabu House, Green House Kitchen & Bistro, Cat's Pajamas Club & Resto, and Curabhaya Lounge. **(Annual Report 2015, PT MAS MURNI INDONESIA, Tbk)**



In the restaurant business, the company through its subsidiary company which is PT Graha Mediatama Megacom (GMM) manages some *dim sum* outlets with a brand “Orchid Hong Kong Dim Sum” in some areas in Surabaya. GMM also run Resto and Lounge Cat’s Pajamas in Garden Palace Hotel area. GMM develops its enterprise through Clark Hatch Fitness Centre & Spa which completes the facility of Garden Palace Hotel. **(annual report 2015, PT MAS MURNI INDONESIA, Tbk)**

The company through its enterprise PT Sahadja Niaga has built a new venture that laundry industry which is specialized to serve the hotel industry, restaurant, retail and other companies to expand its market from the growth of the new hotel industry and restaurant in Surabaya. With modern laundry equipment in large scale, it is expected to support the income significantly in the near future. **(Annual Report 2015, PT MAS MURNI INDONESIA, Tbk)**

PT Mas Murni Indonesia Tbk is the company that has a large market in the middle of globalization and regional autonomy. The businessman or even the public employee will be frequent traveling during working and they require the safety accommodation. With a cheap price to be offered, the smart market demands a quality on the cost that is spent. Otherwise, it should have high loyalty if the need is satisfied. The company attempts to get closer to the customers in the level of local market, corporation, public employee, and tourist. **(Annual Report 2015, PT MAS MURNI INDONESIA, Tbk)**

PT Mas Murni Indonesia Tbk is the expectancy of the company management so that the government invents the hotel industry as the source of foreign exchange. The remaining of the beauty of East Indonesia, it will contribute in the hotel sector indirectly. Traveling in a venture context or touring has become the necessity nowadays. These things are the indicator for the company to view this enterprise potency based on the confidence on a bright prospect in the future. **(Annual Report 2015, PT MAS MURNI INDONESIA, Tbk)**

Per 31 December 2015 it is divided into three stakeholders which are, mostly stock of series A is owned by the people with the total stocks of 170.637.500, the stock of series B is owned by some companies and people such as Tumaco Pte.Ltd, PT.Sentratama Kencana, Jade Bond Limited, and PT. Asabri, and the stock of series C is owned by the people about



6.000.000 stocks. The total stock of PT Mas Murni Indonesia that spreads is about 3.313.240.330. stocks. (**Annual Report 2015 PT MAS MURNI INDONESIA, Tbk**)

For the competitor of this company which focuses on the four stars hotel such as Garden Palace Hotel. The hotel's target sales are focused on the family, foreign tourist, or businessman. The hotel is located in Yos Sudarso street No. 11, Embong Kaliasin, Surabaya surely has a class competitor such as Paragon Java Hotel.

Analysis of Vision and Mission

Vision

The Company has long-term vision as one of the medium scales up in managing the hotel industry and services sector in a company.

Vision Analysis. According to the vision of the company. Which the company became a middle up-scale company in managing the property. In this case, the vision of the company is less focused and less efficient in managing its vision. In 2014 there was a ratio increase of the companies that could escalate the scale of the company. But, in 2015 the company began to be less effective than earlier investments in which a decline in investor's trust can be viewed in NPM. It became an assessment which explained that the company began less effective and efficient.

Mission

The mission is to improve both operationally and managerially every year. The Company also continues to be utilizing any growth momentum by establishing strategic alliances that have complementary synergizing and benefiting. The company always strives to constantly innovate and look for new ways to improve its performance.

Mission Analysis. The number of subsidiary company owned by this company is to achieve its vision and mission synergizing with each other. By synergizing and benefiting each other. However in 2015, the enterprise less effectively achieved profitability. It could be caused by a lack of cooperation or synergy of between companies which led to a decrease in stock prices. It could be also caused by the utilizing asset ineffectively.



Business Environmental Analysis

The results of the analysis of opportunities and threats of the company based on external environment analysis in terms of political and regulatory, economic environment, sociocultural environment and ecological. In terms of politics and regulation which consist of laws, regulations, and government or local regulations. The company already obeyed the regulation about government licenses that became opportunities for the company and escalating the level of consumer trust. The political situation would affect the existence of the company if the economic and political situation in an area is conducive, it will be a very good influence on the survival and growth rates of the company, and vice versa. The economic environment is the factor that has the direct impact on companies such as banking interest rates, unemployment rates, wages regions/cities, and devaluation/revelation and energy availability. These points are related to each other so that the company would rather need to pay attention to the opportunities and threats than the economic environment.

Then, the social and cultural environment like a lifestyle changing if the higher needs of a community or a family on lifestyle then the Garden Palace Hotel could be a choice of places to stay and spend time with the family, because the Garden Palace Hotel provides the facilities to support modern lifestyles, but over time the change in one's lifestyle could be altered and this is a threat for the company or even the opportunity to develop and deliver what facilities are needed by the community. Then, there is level of family formation in which each member of the family, the more burdened by one to rent a room and hotel facility. Then there is the population growth and the level of morality that all these points related to the social and cultural environment. The technology also plays an important role in the development of a company. In the digital era, the company is required to make changes where all the activities of buying or ordering goods or services can be shopped via online. And the last thing is the ecology, such as climate change, the changes in natural resources, potential natural disasters and the damage to the environment which could impact the decrease of selling price of both services and stock as a result of a sudden change that cannot be predicted when it would happen nevertheless, the company could anticipate or prepare at any time when the change is coming.



PT Mas Murni Indonesia Tbk in the sales system uses a second agent service as a media for booking, both *online* and *offline* which is using agents such as tour and travel or social media website. The marketing area of the PT MAS MURNI INDONESIA, Tbk product only focuses in Surabaya. The company has three types of product that are marketed in services field. In average customers are from community and event organizing. Meanwhile most customers are from middle and upper social state. Therefore, this place is built for exclusive people. However, to reach out other markets, the company also does not ignore the middle-class market. Therefore, the company enhances some aspects of the certain class.

Competition Analysis

There are six strengths in industry required to be paid attention by the management of company such as a threat of new entrants where the HOTEL industry will be developing in Indonesia. Due to AEC (ASEAN Economic Community) momentum, Surabaya as the second big city after Jakarta, therefore, the four stars hotels will prepare everything that relates to business changes so that the investor feels comfortable and satisfied during the meeting in Surabaya. Rivalry among existing firms of the four stars hotels industry is quite a lot in Surabaya, such as Java Paragon Hotel. The threat of substitute product, the company that moves in service area especially hotel can be substituted or even threatened with the guest house which provides affordable price and its facility is as the same as the four stars hotel. Bargaining power of buyers, the more appearance of the guest house which is made alike as our own house invents the company which moves in the hotel industry will be overwhelmed and make the customer think twice to use guest house or hotel. Bargaining power of suppliers, the kind of the company which is established will increase suppliers' choices to cooperate with the certain company. And the last is a relative power of other stakeholders, there is a constitution which regulates business hotel and tourism permission and monitoring by the holding company and local government then the conclusion that can be taken from six threats in the industry is that the HOTEL industry will be developing in Indonesia, it is due to social media. Why? Because through social media, the beauty of Indonesia can be freely exposed without visiting the certain place. Tourism cannot be separated from the hotel.



Therefore, the industry is demanded to keep innovating so that the tourists who wish for vacation or doing business interest can be served well.

Key Success Factors Analysis

There are key success factors of Garden Palace Hotel, the first is Garden Palace Hotel offers competitive price, second are the location of Garden Palace Hotel is in strategic place which embraces Surabaya, access to entertainment place, mall, airport, harbor, and train station and the last Garden Palace Hotel offers international facility with affordable price. Java Paragon Hotel which are the competitors for Golden Palace Hotel uses the same service from the second side such as tour travel agent online and offline to ease the access to booking hotel. These three hotels are using the same tour and travel agents. Strategic factor analysis, the company has some points which is, Garden Palace Hotel is a four stars hotel which has 24 floors with 370 rooms capacity with international standards such as standard room, superior room, deluxe theme, club royal, club royal suite, ministry suite and sultan suite, on java paragon hotel room number that only has 290 rooms. With prices tend to be slightly more expensive than gardenplace hotel.

Those are the hotel primacy in the long-term but, they will change anytime. The room price is offered with the low price compared to other competitors but, it is situational and can change anytime which is the hotel primacy in short-term. The hotel location is strategic, at the heart of Surabaya, business central and it only takes a couple minutes from Plaza Surabaya, Tunjungan Plaza, World Trade Center, surrounded by banks and easy access to the airport, harbor, and train station which makes them have the hotel primacy in long term. With the strategy which has been applied by Garden Palace Hotel is to create the new website, strengthening e-commerce and online travel agent. The existence of Garden Palace Hotel in online is considered as important because of the development of digital era in Indonesia.

Human resources that have been had by the company comes from various ethnic background which reflects diversity of Indonesia culture, with various ability and equality skill, it can be the hotel primacy in short-term, because people will be getting older and it will demand the company to find new man who is more productive based on age. As the international hotel, Garden Palace Hotel is completed by food and beverages facility such as



mini-court a Chinese restaurant Nishiki shabu house, greenhouse kitchen & bistro, cat's pajamas club & resto, and Surabaya lounge which have made them have the hotel primacy in medium-term. Through their subsidiary company PT. Graha Mediatama Megacom (GMM) which manages some outlet dim sum with the brand "orchid Hong Kong dim sum" in some places in Surabaya can be the hotel primacy and profit for the hotel in medium-term.

The firm through their business group PT Sahadja Niaga has developed unit business in laundry service which is reserved for the hotel industry, restaurant, retail and other companies to wide market opportunity from the growth of the new hotel and restaurant in Surabaya and it can be the hotel primacy and a profit in long-term. In implementing this target to escalate the market, the company plans to take strategic steps in short-term such as (1) to continue renovation program of Garden Palace Hotel, meeting rooms, restaurant, lobby and exterior hotel building and enhance other facilities. (2) to rebranding and public relation campaign in promoting the image of the new Garden Palace Hotel, convention, and restaurant. (3) to marketing more intensive through reservation online. (4) to increase efficiency and productivity in every field on and on; and (5) to develop human resources to be more competent, have higher motivation and priority in increasing quality.

The strategic factor is performed by the company in medium-term. The marketing strategy has been enacted by Garden Palace Hotel is the dynamic strategy of the product and service. Team hotel learns specifically market segment that makes the customer loyal to the hotel, the new trend of sale in Indonesia, launch product innovation and interesting service to enhance competitive value on the market in Surabaya. The product innovation relates to new lobby entrance which is more modern and new menu for foods and beverages. Garden Palace Hotel applies the service innovation such as check in express for the business guest.

Business Performance Analysis

Corporate Social Responsibility Performance

As a company that moves among the society, this company gives the positive impact on people such as organizing blood donors, cooperating with the related institution. Taking



responsibility for people's education around the area of a company. Recycling waste and running energy saving program. Also, planting palm for O2 absorption.

Market Performance

To carry the function of a business, the company must have the strong marketing strategy. The company has the various products of hotel rooms and restaurant also laundry service for the company to develop. However, a lot of hotel rooms are not strong enough because the competitors have various hotel rooms too.

Financial Performance

In this study about financial performance uses the annual report in 2014 and 2015. Here is the ratio analysis.

Table 1

Ratio/years	2015	2014
Liquidity Ratio		
Current ratio	0.9648034 49	0.9373758 5
Quick ratio (acid test ratio)	0.9026035 81	0.8752532 46
Cash turnover	45.837587 91	39.121999 08
Inventory to net working capital	- 1.6067912 71	- 0.9919911 89
Leverage ratio		
Debt to asset ratio	0.2488610 73	0.2212410 64
Debt to equity ratio	0.3313116 44	0.2840944 14



Long-term debt to equity ratio	0.0299667 12	0.0281758 07
Times interest earned	1.5064198 11	2.0367576 82
Activity Ratio		
Receivable turnover	32.885923 48	15.347161 21
Inventory turnover	26.089668 64	29.131045 31
Working capital turnover	- 41.920651 84	- 28.897740 26
Fixed assets turnover	0.1699296 88	0.1888517 76
Total assets turnover	0.0983973 31	0.1083471 19
Profitability Ratio		
Gross profit margin	0.5053451 39	0.5160905 95
Return on investment	0.0026996 96	0.0047367 14
Return on equity	0.0035941 37	0.0060823 88
Earning per share	0.8948928 04	1.5613789 15
Net profit margin	0.0274366 79	0.0437179 48
Market Ratio		
Gross profit margin	268.18854 61	153.71028 63



Growth ratio		
Sales	781682257	826169678
	13	61
Net income	214467652	361184467
	5	6

It can be viewed from this analysis and the increasing of the ratio as an indicator of the company, the sales have decreased a year before. The company performance can be detected from net income which decreases from a year before and it indicates the decreasing of company performance and it worsen the condition of the company viewed from asset proportion which does not seem better due to the company uses debts for paying the asset. It means that if the company is going to be this way, it will worsen the company condition due to the debt will be escalating when the new asset is enhanced. Debt-to-equity, the ratio of the company will make the debt bigger than the capital. The composition of capital is smaller than the debt will lead the company to collapse.

In using the asset, compared to a year before, the company was not good at selling. The company is not efficient in using the asset. It worsens the company because of the ineffective and inefficient of using the asset. The company invests and expects a profit from their investment. The result of return on investment, the company has been decreasing which means that the company is not effective in managing their investment. The decreasing of investment can be detected from net profit margin in last year. The worst condition of the company in the eye of the investor can be viewed from earn per share decreased last year. It lessens the investor trust to invest in this company because the holding income has decreased in 2015.

The decreasing of the financial company in a year before, the firm has the long-term vision as one of the best company in managing the HOTEL industry. Based on their vision, the company will manage a business property. In this case, their vision is not focused and efficient in managing their vision. It can be detected in 2014 where the company ratio increased but, in 2015 the company was ineffective in investing which influence the investor trust and it could be detected from net profit margin. Their mission is to take an improvement



step in operational and managerial. The company will harness every development momentum by establishing strategic alliance which completes and benefits each other. The company always attempts to innovate and find a new way to increase the performance. After analyzing the mission, it can be concluded that a lot of subsidiary companies which are had by this company to accomplish their vision and mission. In 2015, the company was ineffective in receiving the profit, it because of the lack of cooperation and synergy among the subsidiary company.

Operation Performance

The value chain of this company can be detected from the infrastructure management. The company always gives the best quality. Running SOP to assure the service and product are equal to everyone. Logistic distribution is beyond the customer expectation. The company controls every area which will persuade the customer. With the professional human resources, the company ensures their operational system. The technology development nowadays, the company ensures the centralization quality. The use of vendor based on the internet for sales becoming value-added for the company in using technology. From the criteria mentioned above, the company provides the strategic location for the customer and easy to access all units. This aspect is not had by the competitors. Viewed from the technology aspect, this attempt is usual and the same as the competitors do but, the company has value-added from the place, service and interesting layout which is not had by the competitors.

Human Resources Management Performance

The company manages human resources beginning with experience and capability, trusted, teamwork and managerial skill can be the advantage and resources but, in some aspects could be imitated by other companies. Garden Palace Hotel belongs to PT MAS MURNI INDONESIA Tbk which has the reputation in Surabaya and this can be the advantage for the company in promoting their brand worldwide. In the process of recruitment, the company motivates and maintains human resources capital so that it could be the advantage to compete with the competitors.



CONCLUSION

Marketing Performance is the business aspect

PT MAS MURNI INDONESIA, Tbk performs a task or business function, the company has an extremely strong market. The company owns a kind of hotel rooms and restaurants and the laundry industry is the power for the company to expand. But, the number of hotel rooms and room types are not the company strengths because the competitors also have many types of rooms. With the existence of IBT is around in the same place near to the hotel would become a good selling especially for the hotel. The company has additional targets mainly businesses in east areas which becomes its own selling points for the company. In addition, the company is also heavily promoting differently in every service provider sites such as rebates up to 100,000 for the family room, and free *cashback* 5% free transaction when booking online.

Business Performance of Financial Aspect

From this analysis can be viewed from a leverage ratio as an indicator of a company, the sales decreased from the previous year, and this decreasing was caused by many things which have been described above. To view the company's performance can also be detected on the net income that shows a decrease from the previous year, and it indicates that the company's performance declined. And it worsens the condition of the company. It is detected from the proportion of the assets owned by the company seems unwell due to the increasing which indicates that the company is using debt to assets owned payment. Which means that if the company is going this way, it will worsen the condition of the company due to the company utilizes the debt to pay off the asset. And also the debt-to-equity ratio of this company is higher than the capital. The composition of capital is smaller compared to the debt indicates that the company will have to bear the higher debt than the capital as a result of this condition it would lead the company to the possibility of bankruptcy. In the utilizing assets compared with the previous year, the company was not as good at the sale. The company is inefficient in the use of assets. The company invested and expected the benefit from the investment made by the company. From the results of the return on investment of



this company shows the decline. Which means that this company showed a decline, which means the company is not effective in managing the investments made by the company itself. And it cannot be denied that the decline in investment of the company is detected from a net profit margin which shows deterioration compared to the previous year. The decreasing of the investor trust to invest in this company is caused by the shareholder's earnings per share have decreased which of the financial explanation can be viewed that the company was not better than the previous year. In 2015 the company has decreased and begun to worsen the image of the company. Because the ineffectiveness and inefficiency in management of finance, or other things that may aggravate the image of this company in the eye of stakeholders. Viewing from the company strength in financing which decreased from the previous year, the company possessed a long-term vision as one of the medium scales up in managing a property. Based on the vision of the company, which the company is a medium-sized company in managing the property. In this case, the vision of the company is less focused and inefficient in managing its vision. This was detected in 2014 where the increasing in the ratio of the company which could escalate the scale of the company but, in 2015 the company began to be ineffective than investments where the decreasing in investor trust could be viewed on the net profit margin (NPM). Of course, this could be one of the assessments which explain that the company was ineffective and inefficient.

Business Performance of HRM Aspect

For the human resources management, the company begins with the experience and capability, the ability to trust, teamwork effectively and managerial skills can be an advantage and a source for the company but, in some cases, these strengths could be emulated by other companies however, every company has its own characteristic of human resource. By training the candidates in several stages and the employees make this company have an identity on its employees. Garden palace hotel which is a hotel owned by PT MAS MURNI INDONESIA, Tbk has a reputation and a brand in Surabaya, this could be the strength of the company to intensify promotion or marketing so that the reputation of the recruitment process itself can spread out the company to motivate and retain the human resources capital so that it can be an advantage in order to contend the competitors.



Business Performance of Operation Aspect

For the value chain of the company is detected in managing the infrastructure of the company. The company always provides the best quality. By running SOP that guarantees the service and the product going the same way for every person. With the logistic distribution is performed beyond the customer expectation. For the service, the company performs controlling activities in each area that will affect the consumers. With the qualified human resources, the company ensures the operational and responsibility on every operation. In addition, with the development of technology, the company performs centralization quality control so that it creates a good product and unchanging service. The increasing of the Internet-based vendor for the sales become added value for the company in the utilizing of technology.

RECOMMENDATION

The three strategic factors of a company for long-term period such as (1) the company through its subsidiary has developed a business in 2013 by opening Clark hatch garden palace fitness and spa. (2) Extending market opportunity, the company builds laundry service due to the growth of hotel and restaurant is getting developed. (3) Improving the management to escalate the standard of product, restaurant service, lounge, fitness center and laundry service to give the product and service beyond the customer expectation. (4) Increasing the marketing strategy for restaurant service, lounge, fitness center and laundry service. (5) Escalating the program for ability and motivation of human resources to be more competent and commitment to the company. (6) The company built IBT building (East Indonesia) center and has been operating since 2016, the building function is for office, information center, promotion, investment, trading and tourism for East Indonesia. (7) The company through its subsidiary in 2015 developed property project in Gresik and started to market in 2016.

As a customer-oriented company, the increase of quality and service is something important in running the business. Almost all process and element systems are designed and implemented to satisfy the customer. In assessment meeting, the management discussed the cause of success or failure in accomplishing the customer satisfaction and gave the input to set a new target for the next year.



REFERENCES

- Arikunto, Suharsimi. (1986). *Prosedur Penelitian Suatu Pendekatan Praktek*. Jakarta Bina Aksara.
- Ary, D. Jacobs, & L.C.Razavieh. A. (1982). *Pengantar Pene/itian dalam Pendidikan*. (Penerjemah Furchan,A). Surabaya: Usaha Nasional
- Azhar Susanto, (2004). *Sistem informasi manajemen*. Bandung: Linggar Jaya
- Dessler, Gary, (2008). *Human Resources Management*. New jersey: Prentice Hall, Inc
- Eckerson, W. 2006. *Performance Dashboards: Measuring, Monitoring, and Managing Your business*. Canada: John Wiley & Sons, Inc.
- Fandy Tjiptono, (2009). *Strategi Pemasaran Jasa*. Cv. Andi:Yogyakarta
- Gitman J. Lawrence and Chad J. Zutter. (2012). *Principle of Managerial Finance*, 13th edition. England: Pearson.
- Heizer, J. & Render, B. (2011). *Operations Management. Tenth Edition*. Pearson, New Jersey, Usa.
- Kotler, Philip, dan Kevin Lane Keller. (2009). *Manajemen Pemasaran Jilid 1*, edisi ketiga belas, terjemahan Bob Sabran, MM. Jakarta: Penerbit Erlangga.
- Rufaidah, Popy, (2014)., *Manajemen Strategik*, Penerbit Humaniora, Edisi Pertama, Cetakan Ketiga (Edisi Revisi).



THE IMPACT OF STRATEGIC PLANNING IMPLEMENTATION ON NON-PROFIT ORGANIZATION'S PERFORMANCE EFFECTIVENESS

Siti Khusnul Rifani

Master of Science in Strategic Management Student, Economics and Business Faculty

Universitas Indonesia

sitikhusnulrifanibadrudin@gmail.com

Tengku Ezni Balqiah

Senior lecturer in Faculty Economics and Business Universitas Indonesia

Abstract

Strategic planning is important for non-profit organization to make sure they have been achieved their missions and take necessary actions to achieve it. And they could achieve greater benefits if they applying strategic planning which outweigh the cost involved in the implementation process. But the relationship between strategic planning and organizational performance has been rarely examined in the public and non-profit sectors, especially in Indonesia. This study empirically examines the effect of strategic planning on one of Indonesian non-profit organization's performance effectiveness. The performance effectiveness assess by using the multiple perspective of Balanced Scorecard (BSC). Niven (2008) developed the BSC for non-profit organization which has added the fifth perspective, volunteers' development. We argue that the strategic planning can help to guide the implementation process to achieve organization's performance effectiveness. A purposive sample of 30 managers and project leaders was selected for participated in this study to measure the impact of strategic planning on this organization's performance effectiveness. All data will be analyzed through quantitative method. We believe that the result of this study will contribute to strategic management area of research and practices on how to measure the strategic planning implementation on the organization's performance effectiveness by using balanced scorecard, especially in non-profit sector in Indonesia.



Keywords: *strategic planning, mission achievement, performance effectiveness, non-profit organizations, the balanced scorecard (BSC)*

JEL Classification: *L25*

INTRODUCTION

The non profit organizations are required to respond to the great challenges of urging change in the dynamic environmental forces that could threaten their survival. It would be useful to understand if these forces are hindering movement towards strategic planning. These forces include budget control, lack of staff, size of the organization and range of operations, changing customers' expectations, government policy changes, comparability, stronger competition with other existing as well as emerging non governments, competition for international donors', accountability imposed by multiple stakeholders groups including public administrators, legislators, and citizens, staff and volunteers, and continuous government failure to satisfy public needs which increase the public demand for the services offered by these organizations (Eisenberg, 2004). A number of challenges have surfaced in recent years, however, that have complicated the strategic management process. Some of those challenges include the impact of globalization, electronic commerce, diversification of the workforce, the learning organization, rapid technological advances, governmental regulations, and increasing competitive forces in the environment (Wheelan and Hunger, 2008).

Strategic planning is important to non profit organization to assess how far they have been achieved their missions and take necessary actions to achieve it (Franklin, 2011). And they could achieve greater benefits if they applying strategic planning which outweigh the cost involved in the implementation process. Non governmental organizations/nonprofit organizations are required to apply a formal strategic planning process and using balanced scorecard to measure the performances effectiveness that guided by their missions and vision statement. The stakeholders demand increased accountability and overall organizational performance indicators, therefore, that balanced systematic way to promote better organizational performance and assess the performance is becoming increasingly important.



The relationship between strategic planning and organizational performance has been rarely examined in the public and nonprofit sector (Stone and Brush, 1996; Stone, Bigelow, and Crittenden, 1999). Also, most of the research has been confined to examining the nonprofit sector in the western society and very little has been conducted in nonprofits in developing countries like Indonesia. Kriemadis and Theakou (2007) and Robinson (1992) recommended that future research efforts should investigate the impact of strategic planning on organizations' operational and financial outcomes.

In this study, I will focus on a non-profit organization that is working in the field of nature conservation. This organization started working in Indonesia as a Program Office of their International organization in the early 1960's, under the auspices of the Ministry of Forestry. At this early stage main activities were surveys and research on mammal species, especially the endangered rhinoceros and tigers on the islands of Java and Sumatra. The results of research later led to the efforts of conserving the forest habitat of which these species depend on. Ujung Kulon National Park on the western tip of Java was the first this organization's field site in Indonesia. In the 1970s, the number of projects and areas covered under the program office grew significantly.

This nonprofit organization started many terrestrial conservation initiatives in Sumatra, Borneo, Sulawesi, and Papua. In the first half of 1980s, they had a program in collaboration with the government developed a strategy for marine conservation. Implementation of a Marine conservation program started in the early 1990s. This organization obtained legal entity in Indonesia and was registered as a foundation, or *yayasan*, in 1996. With the new legal status, and National Office status from their International Board, this nonprofit established its own Board of Trustees, and secured much more flexibility in fund raising and program development.

In April 1998, they transformed becoming legalised as an Indonesian organization with foundation status. With this change, they became a National Organization within their Global Network, which consists of 27 National Organizations, 6 Associate Organizations, and 22 Program Offices around the world. Until 2004, they has assisted the Government of Indonesia in the establishment of forest conservation areas.. In the development of Management Plans for these areas, they promoted the role of local communities in natural



resource management and encouraged legal recognition of customary rights over access and use of natural resources in protected areas that are important for communities' livelihoods.

They has also facilitated and supported the development of sustainable economic alternatives for local communities. Currently, this organization is continuing efforts in support of capacity building for better management in most of these conservation areas. Today, they work in 25 sites, spread throughout 17 provinces in Indonesia.

Therefore, I am interested in doing a study to empirically examine the effect of strategic planning on the performance effectiveness of this nonprofit organization as recommended by Robinson (1992). An assessment of the effectiveness of performance will be created using multiple performance measurement perspective offered by the balanced scorecard. Balanced scorecard, which originally consisted of four perspective lists, will be modified to include a fifth perspective which is volunteers' development. This tool is modified to be used to assess the impact of strategic planning on the performance of the non-profit organization that is reflected by the accomplishment of the mission in an Indonesian nonprofit organization.

LITERATURE REVIEW

Strategic planning allows nonprofit organizations to better understand their external environment then formulate strategic plans for effective performance (Moxley, 2004). He argued that nonprofit organizations use mission-based strategic planning to communicate their purpose to various stakeholders groups. This improves their legitimacy and secures stakeholder's support which is important for mission achievement. The nonprofit organizations have a wide range of strategic planning models and approaches which can be used to achieved their performance (Franklin, 2011). These models serve as a chart in guiding the strategic planning processes thus, they offer clarity, save workload, and focus organization's attention on important strategic planning practices (Trainer, 2004).

The model which developed by Rhoes and Keogan 2005) links strategy implementation to human resource management and organizational structure since they are all interrelated. This model is constructed by five main components; mission, strategy content, external environment, organization's structure and Human Resources approach, and



process. This framework provides a widespread base to estimate strategic planning practices in NGO's (Blackmon, 2008). It is considered all-inclusive because it spans the conventional aspects of strategic planning processes to cover the implementation stage, which is generally the concern of the broader strategic management ground. The model also enables organizations which are using it to assess their performance with the multiple perspectives of the BSC which are mostly enclosed by the model. Finally it has been empirically examined before in the study efforts of Blackmon (2008) and Franklin (2011) which gives it more reliability to be duplicated in different research contexts.

Environments

Nonprofit organizations' external environment is composed of government regulatory bodies, private organizations, other nonprofits, citizens, donors, and beneficiaries (Barman, 2002). As majority of nonprofit organizations are based on donors' funds, Stone, Bigelow, and Crittenden, 1999 argued that external funders have a greater influence on nonprofits' strategic management efforts. Nonprofit organizations' internal environment is composed of organization's capacity, management, leadership, and internal networkings. This might create dilemmas in managing the internal environment which becomes somehow complex (Blackmon, 2008).

The environment is a factor that greatly contributes to the conditions because it will determine what strategy to be executed (Covin and Covan, 1990, Miller and Friesen, 1982), is determined by environmental forces. According to Pearce and Robinson (1997) formulation of a strategy guide the executive to set organization's policy to achieve the ultimate goal and the necessary actions to achieve the ultimate goal. Formulation of effective and efficient strategy is the formulation that combines future-oriented perspective to the external business environment and internal environment of the organization.

Mission

Developing mission statements in nonprofit organizations is an integral part of their strategic plan efforts and should be considered as the core of the balanced scorecard assessment process (Blackmon, 2008). The mission has to be aligned with the organizations'



goals and objectives to facilitate the implementation of strategic plans. It can either impose restrictions or provide opportunities for the organization depending on its chosen strategic direction (Brown and Iverson, 2004). However, in all cases, missions have a long lasting effect on nonprofit strategic planning practices (Rhodes and Keogan, 2005).

Human Resources Management and Structure

Several authors advocated the strategic view of human resources management and that it has to be incorporated into nonprofit's overall strategic planning efforts so that it can further be utilized as a strategic rather than traditional support function to promote for greater competitive advantage (Cakar, Bititci, and MacBryde, 2003; Macpherson, 2001).

The researcher agrees with authors' contention about the strategic role of human resources management and how it can be an integral part of organization's strategic planning efforts. Accordingly, the payoffs of managing human capital strategically have to be measured in terms of employees' continuous learning and growth potential which is one of the key performance measurement indicators presented by the balanced scorecard. This is what the proposed research attempts to examine.

Strategic Plan Implementation

Effective strategic planning is not a guarantee to successful strategic management efforts in either for profit or nonprofit organizations. The implementation stage carries the greater weight in making strategic management efforts successful. Implementation is interrelated with the other components of the strategic planning model developed by Rhodes and Keogan (2005). These components include human resources management, organization's structure, operational plans, and monitoring. Thus, implementation is a critical component of organization's strategic planning model as a tool to promulgate for better strategic management practices in nonprofits.

Non Profit Organization

Franklin (2011) noted that nonprofit organizations need to function at the highest level of operational efficiency and performance effectiveness because they are using public



and donors' funds. Nicolae advocated that nonprofits need to use strategic planning due to their exclusive reliance on public and donors' funds. Consequently, they can utilize strategic planning to retain public credibility by being accountable to donating bodies who want to make sure that their money is best channeled through nonprofit activities for some good reasons (Franklin, 2011).

Hassan (2010) mentioned that among the determinants of nonprofits' success is the relevance of services provided to social needs, which is a sole assessment of customers (this resembles the customer perspective of the balanced scorecard). He mentioned also that the effectiveness of these organizations is based on well known performance benchmarks (this represents the financial perspective of the balanced scorecard) and the application of strong governance mechanisms. Thus, effectiveness of nonprofit organizations should be evaluated using a multi-dimensional approach like the balanced scorecard.

The Balanced Scorecard for Non Profit Organization

Since many nonprofit organizations are primarily mission-driven and the balanced scorecard is centered on achieving mission (as the goal) while linking together organization's strategy (as the core), internal business processes, employees' learning and growth, customer processes, financial processes, and volunteers' development (as proposed), it is becoming a significantly important strategic exercise for these organizations. Niven (2008) declared that achieving nonprofit organizations' missions will not occur in one day. He suggested that the multiple perspectives of the balanced scorecard should be considered in assessing organizational effectiveness. Because, information feedback gained from these perspectives helps organizations to make necessary adjustments leading to mission achievement. The balanced scorecard measures nonprofit organization's performance by collecting data from the five perspectives which it presents. This measurement process portrays causal relationships between the impacts of strategic planning on organization's performance in a more accountable fashion (Kaplan and Norton, 2000).

The balanced scorecard was adapted for application to nonprofit organizations whereby the mission becomes the focal point as it provides a clear direction to the organization (Niven, 2003). Niven (2008) argued that the balanced scorecard in nonprofit



organizations centers on strategy (i.e., strategic plans) as its core with the intention to achieve mission as the ultimate goal. He asserted that the balanced scorecard is important for nonprofit organizations due to its ability to provide feedback regarding organizational progress towards achieving its mission as guided by the concrete strategy(s) on hand.

The customer perspective comes after the mission directly. In public and nonprofit organizations, the customer perspective gains a greater weigh because their satisfaction justifies mission achievement (Niven, 2008). He argued that nonprofit organizations have a diverse customer base including donors who provide organizations with funds, beneficiaries who receive services without normally paying for them and the general public (Kaplan and Norton, 2001). Thus, the customer perspective of the balanced scorecard has to incorporate performance effectiveness as perceived by various customer segments. Based on assessment information gained from the customer perspective, the organization can easily identify critical performance measures in the other four perspectives (internal business processes, employees' learning and growth, financial processes, and volunteers' development).

Kaplan and Norton (1992) also argued that monitoring customer processes through the balanced scorecard helps nonprofits collect information about customers' perceived value, service quality, delivery time and costs, and customers' satisfaction. Thus, they will be able to align their strategic plans to the achievement of higher customer intimacy, superior service quality perception, and operational Excellency.

The financial perspective of the balanced scorecard is imperative for nonprofit organizations because it captures information about how efficiently they are using scarce resources and public/donor funds to offer quality services. Information obtained from this perspective improves organizational accountability towards the public and enhances its fund raising potential. Consequently, makes mission achievement much imminent (Niven, 2008).

The internal business process perspective captures measures regarding organizational operations and processes necessary to meet customers' expectations and increase their satisfaction (Kaplan and Norton, 2000; Niven, 2008). In other words, internal business processes are more about value chain management. Revising and improving internal business processes is dependent upon performance measures identified by the customer processes



perspective of the balanced scorecard. Thus, this perspective can pursue diverse objectives which all aim at improving customers' value perception (Niven, 2008).

The success of nonprofit organizations depends on the depository of skills and competencies implicitly held by its staff which represents its human capital. Therefore, there is an obligation on nonprofit organizations to continuously improve employees' learning and growth potential, manage information sharing, and provide an adequate organizational climate conducive to improving overall organization's performance as represented by mission achievement (Niven, 2008).

Employees' learning and growth captures information about human capital and information technology needed to achieve competitive advantage (Kaplan and Norton, 2000). This dimension is mainly concerned with evaluating the skills, knowledge, and competencies held by organizational human capital and finding out ways to continuously improve them.

Due to increased professionalism pressures in human resources management in nonprofit organizations, they are called upon to apply extensive internal controls and sophisticated volunteers' training and development techniques (Stirling, Kilpatrick, and Orpin, 2011). Therefore, a new dimension is introduced to the balanced scorecard which is Volunteers' Development.



Figure 1. Balanced Scorecard for NGO

Source: Niven (2008) Blackmon (2008)

METHODOLOGY

Research design

Kombo and Tromp (2006) stated that research design is a paramount strategy which is used in carrying out the research. The study was conducted using a descriptive and inferential design. This study was carried out through use of descriptive study. A descriptive study is suitable design for answering the research questions because it was particularly useful for studying educational innovations, evaluating strategies and in forming policies (Flyvberg, 2006). Descriptive study in depth rather than breadth and placed more emphasis on the full analysis of a limited number of events or conditions and other interrelations.

Research Model and Hypotheses

Based on the literature review and the results of previous studies, we compiled framework to determine the impact of strategic planning implementation on non-profit organization's performance effectiveness with skeleton models as follows.



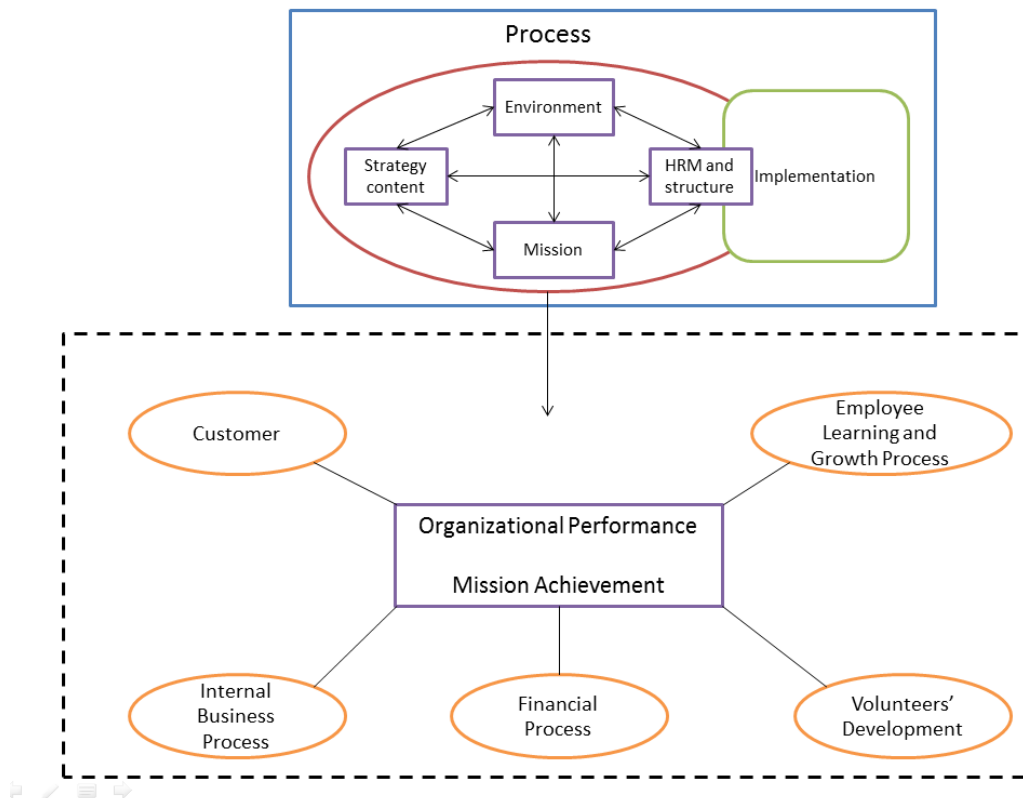

Figure 2. Research Model

As we seen in the picture above, we can formulate the research hypotheses as follows:

- H1.** There is a positive relationship between strategic planning and organizational performance in non-profit organizations as measured by the Balanced Scorecard protocol.
- H2.** There is a positive relationship between strategic planning, mission achievement and organizational performance in non-profit organizations as measured by the Balanced Scorecard protocol.
- H3.** There is a positive relationship between strategic planning, mission achievement, customer processes, and organizational performance in non-profit organizations as measured by the Balanced Scorecard protocol.
- H4.** There is a positive relationship between strategic planning, mission achievement, customer processes, internal business processes, and organizational performance in non-profit organizations as measured by the Balanced Scorecard protocol.

H5. There is a positive relationship between strategic planning, mission achievement, customer processes, internal business processes, employee growth and learning processes, and organizational performance in non-profit organizations as measured by the Balanced Scorecard protocol.

H6. There is a positive relationship between strategic planning, mission achievement, customer processes, internal business processes, organizational growth, and learning processes, financial processes, and organizational performance in non-profit organization as measured by the Balanced Scorecard protocol.

H7. There is a positive relationship between strategic planning, mission achievement, customer processes, internal business processes, organizational growth, and learning processes, financial processes, volunteers' development and organizational performance in non-profit organizations as measured by the Balanced Scorecard protocol.

Population and Sampling Design

Neuman (2000) defines a research population as the specific pool of cases, individuals or group(s) of individuals which the researcher wishes to investigate. The target population for the research was the management of this Non profit organization. Meanwhile sampling design is the process of selecting the unit of analysis of a population that is interesting to learn that by studying samples, researchers will be able to generalize the results of this study refers to selected population (William M.K., 2006). Sampling design refers to the work plan that provides details about the framework of the population, the sample size and sample selection procedures to make explicit population characteristics (Cooper & Schindler, 2005). According to Roscoe (1975) (in Sekaran, 1999) sample size of more than 30 and less than 100 according to most research. And the sample size used in this study were as many as 30 respondents who are the management of this non profit organization.

Table 1. Sample Design

Sample Category	Sample Size	Percentage
Top Management	10	33.3%
Middle Management	20	66.7%
Total	30	100%



RESULTS

Simple and multiple linear regression analysis were used to test research hypotheses. General organizational performance was the dependent variable as measured by the six domains of the BSC performance effectiveness scale. These domains are mission achievement, customer processes, internal business processes, employee learning and growth, financial processes, and volunteers' development. The organizational change scale captured information about these six domains to cross validate data obtained in earlier sections of the questionnaire. Multiple regression analysis was used to test research hypothesis using data collected from entirely completed questionnaires.

Research Hypothesis 1

Regression analysis was performed to test hypothesis 1. The R² indicates how well the data fits the model (Norusis, 2008). The R² for this model was .592 and the observed significance level for the F statistic was .000 which is less than the alpha of .05 for a 95% confidence interval. Thus, the null hypothesis can be rejected and research hypothesis 1 is supported. The beta coefficient for strategic planning was positive and high .803 and about 59% of the variations in organizational overall performance are explained as a result of using strategic planning activities.

Research Hypothesis 2

In order to test hypothesis 2, regression analysis was conducted. The R² for research hypothesis 2 was .752 and the observed level of significance for the F statistic was .000 which is significant at alpha of .05 with a 95% confidence interval. Thus, the null hypothesis can be rejected and research hypothesis 2 is supported. Therefore, there is a positive relationship between strategic planning, mission achievement, and general organizational performance change. Also, approximately 75% of the variation in general organizational performance change can be explained by strategic planning activities and mission achievement. Mission achievement alone contributes to explaining about 8% of organizational performance change over strategic planning activities.



Research Hypotheses 3

In order to test hypothesis 3, regression analysis was performed. The R² for research hypothesis 3 was .802 and the observed level of significance for the F statistic was .001 which is significant at alpha of .05 with a 95% confidence interval. Thus, the null hypothesis can be rejected and research hypothesis 3 is supported. However, approximately 80% of the variation in general organizational performance change can be explained by strategic planning activities, mission achievement, and customer processes. Customer processes alone contribute to explaining about 5% of organizational performance change over strategic planning activities and mission achievement. Also, beta coefficient for customer process was negative which indicates a negative relationship between customer process and general organizational performance change in this organization.

Research Hypothesis 4

In order to test hypothesis 4, regression analysis was conducted. The R² for research hypothesis 4 was .817 and the observed level of significance for the F statistic was .118 which is greater than an alpha of .05 with a 95% confidence interval. Thus, the null hypothesis cannot be rejected and research hypothesis 4 is not supported. However, approximately 81.7% of the variation in general organizational performance change can be explained by strategic planning activities, mission achievement, and customer processes, and internal business processes. Internal business processes alone contribute to explaining about 1% of organizational performance change over strategic planning activities, mission achievement, and customer processes.

Research Hypothesis 5

In order to test hypothesis 5, regression analysis was conducted. The R² for research hypothesis 5 was .836 and the observed level of significance for the F statistic was .048 which is significant at alpha of .05 with a 95% confidence interval. Thus, the null hypothesis can be rejected and research hypothesis 5 is supported. However, approximately 84% of the variation in general organizational performance change can be explained by strategic planning activities, mission achievement, customer processes, internal business processes and



employees learning and growth. Employee learning and growth processes alone contribute to explaining about 1.6% of organizational performance change over strategic planning activities, mission achievement, customer processes, and internal business processes.

Research Hypothesis 6

In order to test hypothesis 6, regression analysis was conducted. The R^2 for research hypothesis 6 was .839 and the observed level of significance for the F statistic was .402 which is greater than an alpha of .05 with a 95% confidence interval. Thus, the null hypothesis cannot be rejected and research hypothesis 6 is not supported. However, approximately 84% of the variation in general organizational performance change can be explained by strategic planning activities, mission achievement, customer processes, internal business processes, employees learning and growth, and financial processes. Financial processes alone contribute to explaining about 0.2% of organizational performance change over strategic planning activities, mission achievement, customer processes, internal business processes, and employee learning and growth.

Research Hypothesis 7

In order to test hypothesis 7, regression analysis was conducted. The R^2 for research hypothesis 7 was .822 and the observed level of significance for the F statistic was .000 which is less than an alpha of .05 with a 95% confidence interval. Thus, the null hypothesis can be rejected and research hypothesis 7 is supported. Accordingly, 82% of the variation in general organizational performance change can be explained by strategic planning activities, mission achievement, customer processes, internal business processes, employees learning and growth, financial processes, and volunteers' development. Volunteers' development alone contributes to explaining about 0% of organizational performance change over strategic planning activities, mission achievement, customer processes, internal business processes, employee learning and growth, and financial processes.



CONCLUSIONS AND IMPLICATIONS

Conclusions

The results of the analysis support and reinforce the role of strategic planning on performance effectiveness of nonprofit organization's as theoretically hypothesized in the previous research efforts of (Al-Shammari and Hussein, 2007; Blackmon, 2008; Franklin, 2011; French, Kelly, and Harrison (2004); Giffords and Dina, 2004; Griggs, 2002) in some ways. Results also support the strategic planning model adopted for the current research which builds on five major components; strategy content, environments, mission, human resources management and organizational structure, and finally implementation with a process-view of strategic planning (Rhodes and Keogan, 2005). This conforms to the results obtained from the previous research efforts of both Blackmon (2008) and Franklin (2011). Results of data analysis for each research hypothesis did not however mostly conform to the results obtained in prior research efforts of (Al-Shammari and Hussein, 2007; Blackmon, 2008; Franklin, 2011; French, Kelly and Harrison (2004); Giffords and Dina 2004; Griggs, 2002). Only five out of seven hypotheses were supported based on the results of hypotheses testing presented earlier. Analysis has indicated a positive relationship between strategic planning and organizational performance effectiveness in the investigated nonprofit organization. The strategic planning model adopted for the current research builds on five major components; strategy content, environments, mission, human resources management and organizational structure, and finally implementation (Rhodes and Keogan, 2005).

A positive relationship between strategic planning, mission achievement, and general organizational change was found also as a result of hypothesis testing. This means that there is a statistically positive relationship between strategic planning and mission achievement in this organization. Therefore, this finding conforms to what Rhodes and Keogan (2005) have mentioned about the role of missions in nonprofit organization which has a long lasting effect on nonprofit strategic planning practices. Also, this confirms the fact that mission achievement is a primary indicator of performance effectiveness of nonprofits which are regarded as mission-driven organizations.



Results however, did not support the use of the BSC performance effectiveness scale as a tool for assessing performance effectiveness of this nonprofit organization. This is because two out of five domains of the BSC performance effectiveness scale did not statistically contribute to explain changes in performance effectiveness of the investigated nonprofit as a result of applying formal strategic planning processes. These domains were mainly internal business processes and financial processes. The new dimension of the BSC performance effectiveness scale which is volunteers' development did however; contribute to explaining the changes in this nonprofit performance effectiveness as a result of applying strategic planning protocols. This might be attributed to the fact that this nonprofit organization is run by volunteers who represent their real human capital power and thus, this dimension carried a higher weight in assessing their performance effectiveness as a result of applying formal strategic planning tools.

Research Implications and Limitations

This research contributes to the study of strategic management in public and nonprofit's in various ways. Following is a brief about research theoretical and practical implications.

Theoretical Implications

1. Contribute to the theoretical argument and previous knowledge concerned with the important role of strategic planning in the management of nonprofits organizations.
2. Enrich the extant body of knowledge with the current status of nonprofit strategic management practices especially in developing countries like Indonesia.
3. Contribute to the existing literature on performance measurement by modifying the balanced scorecard model to better reflect performance effectiveness of nonprofits as guided by the nature of their activities which depend extensively on volunteers' activism. Also, the modified model can be adapted and tested for further improvement in future research efforts.



Practical Implications

1. Communicate the important role of strategic management protocols on nonprofits' performance effectiveness as indicated by mission achievement and sustainable competitive advantage. Strategic planning can be used as a guide to strengthening and sustaining mission achievement in nonprofits.
2. Keep non-profits boards in Indonesia aware of the intense accountability demands and the importance of incorporating the balanced scorecard into their performance effectiveness evaluation efforts.
3. Introduce the modified balanced scorecard to public and nonprofit sector in Indonesia as a strategic performance effective measurement tool. The new tool would allow them to improve their performance as mandated by the demands of the government, clients, and general public.

Limitations of the research

1. Scope limitations due to the inability to distinguish the various models of strategic planning used by nonprofit strategic planners and the impact of each model on their performance effectiveness as measured by mission achievement. The study only examined the application of the strategic planning model measured by the survey instrument developed by Blackmon (2008).
2. Limiting the measurement of performance effectiveness to mission achievement. Other measures of performance effectiveness in the nonprofit sector can include sustainability, market leadership, input-output ratios, and other efficiency indicators.
3. This study was limited to analyzing the data generated through self reports of respondents which might carry a possibility for respondent's bias.
4. Limited Generalizability of research results to the wider nonprofit population in Indonesian nonprofit organizations due of the misrepresentativeness of the purposive sample included in the research and the scope of study is only for one nonprofit organization.



REFERENCES

- Alexander, L. D. (1991). "Successfully implementing strategic decisions". *International Review of Strategic Management*, 2(1), 73-96.
- Al-Shammari, H. A. and Hussein, R. T. (2007). "Strategic planning-firm performance linkage: Empirical investigation from an emergent market perspective". *Advances in Competitiveness Research*, 15(1/2), 15-26.
- Blackmon, V. Y. (2008). "Strategic planning and organizational performance: an investigation using the balanced scorecard in non-profit organizations". *Ph.D. dissertation, Capella University, United States*. Retrieved August, 2011
- Bryson, J. M. (1995). "Strategic Planning for Public and Nonprofit Organizations (A Guide to Strengthening and Sustaining Organizational Achievement)". *San Francisco, Jossey-Bass Publishers*, Revised Edition.
- Chen, Y., Chen, Y., and Chen. J. (2010). "The Influence from the Dynamics of Training and Volunteers' Characteristics on Volunteers' Retention in Non-Profit Organizations". *IJAES*, 8(1), 33-4.
- Dye, Renee; & Sibony, Oivier (2006). "How to improve strategic planning". *The McKinsey Quarterly*, September.
- Franklin, P. W. (2011). "Relationship between Strategic Planning and Nonprofit Organizational Performance". *Ph.D. Dissertation, Capella University, United States*. Retrieved August, 2011, from ProQuest Dissertations and Theses: Full Text database. (Publication No.3440040).
- Ghoneim.N.A. (2012). "The Impact of Strategic Planning on Mission Achievement in Egyptian Nonprofit Organizations: An Assessment using the Balanced Scorecard Approach". *Dissertation on Master of Public Policy and Administration*, The American University in Cairo School of Global Affairs and Public Policy.
- Giffords, E. D., and Dina, R. P. (2004). "Strategic planning in nonprofit organizations: Continuous quality performance improvement - a case study". *International Journal of Organization Theory and Behavior*, 7(1), 66-80.
- Kaplan, R. S., & Norton, D. P. (1996c). "Linking the balanced scorecard to strategy". *California Management Review*, 39(1),53}79.



- Kaplan, R., and Norton, D. (1992a). "The Balanced scorecard: Measures That Drive Performance". (Cover story). *Harvard Business Review*, 83(7/8), 172-180. Retrieved August, 20, 2011 from the Business Source Premier database.
- Kaplan, R., and Norton, D. (2000). Having Trouble with Your Strategy? Then Map It. *Harvard Business Review*, 78(5), 167-176. Retrieved Saturday, August, 20, 2011 from the Business Source Premier database.
- Kaplan, R., and Norton, D. (2001). "Transforming the Balanced scorecard from Performance Measurement to Strategic Management: Part II". *Accounting Horizons*, 15(2), 147-160. Retrieved Saturday, August, 30, 2011 from the Business Source Premier database.
- Littler, K.; Aisthorpe, P.; Hudson, R.; Keasey, K. (2000). "A new approach to linking strategy formulation and strategy implementation: an example from the UK banking sector". *International Journal of Information Management*, 20, 411-428.
- Lysakowski, L. (2005). "Non profit essentials: Recruiting and training fundraising volunteers". Hoboken, NJ: *John Wiley and Sons*.
- Mintzberg, Henry and, Quinn, James Brian (1996). "The Strategy Process: Concepts, Contexts, Cases". *Prentice Hall*. ISBN 978-0-132-340304.
- Munive-Hernandez, E. J., Dewhurst, F. W., Pritchard, M. C., Barber, K. K. (2004). "Modeling strategy management process: an initial BPM approach". *Business Process Management Journal*, 10(6), 691-711.
- Neuman, W. L. (2006). "Social research methods: Qualitative and quantitative approaches (6th ed.)". Boston: *Allyn and Bacon*.
- Niven, P. (2003). "Adapting the Scorecard to fit public and non-profit organizations. In N. Paul, *Balanced scorecard Step by Step Governments and Non-profits* (pp. 27-44)". Hoboken, New Jersey, USA: *John Wiley and Sons, Inc*.
- Niven, P. R. (2008). "Balanced scorecard step-by-step for government and nonprofit agencies (2nd ed.)". Hoboken, NJ: *John Wiley and Sons*.
- Rhodes, M. L. and Keogan, J. E. (2005). "Strategic choice in the non-profit sector: modeling the dimensions of strategy". *Irish Journal of Management*, 26(1), 122-135.



- Rumelt, Richard P. (2011). “Good Strategy/Bad Strategy”. *Crown Business*. ISBN 978-0-307-88623-1.
- Stirling, C., Kilpatrick, S., and Orpin, P. (2011).” A psychological contract perspective to the link between non-profit organizations’ management practices and volunteer sustainability”. *Human Resource Development International*. 14(3), 321–336.
- Stone, M. M., and Brush, C. G. (1996). “Planning in ambiguous contexts: The dilemma of meeting needs for commitment and demands for legitimacy”. *Strategic Management Journal*, 17(8), 633.



**THE INFLUENCES OF ENTREPRENEURIAL ORIENTATION AND ALLIANCE
LEARNING PROCESS ON STRATEGIC ALLIANCE PERFORMANCE OF
INDONESIA CONSTRUCTION COMPANIES**

Retno Handayani

Ratih Dyah Kusumastuti

Department of Management, Faculty of Economic and Business, Universitas Indonesia

retno09handayani@gmail.com

ratih.dyah@ui.ac.id

Abstract

The aim of this study is to investigate the influences of learning process and entrepreneurial orientation of Indonesian construction companies that implement strategic alliances in their businesses. The results of this study are expected to be used to provide insights concerning the important role of learning process in strategic alliance, which is implemented in four processes, namely knowledge articulation, codification, sharing and internalization. This is to ensure that the purpose of alliance establishment can be achieved so that it will have an impact on the success rate of the alliances and gain a competitive advantage that is reflected on the company's performance. In addition, this study will also provide an overview of entrepreneurial orientation that is expected to change operation habits or routines that are so ingrained within the company as well as rigid structure, which can overcome the problem of inertia with building initiative, higher risk-taking and more proactive in entering the new market.

Keywords: *Strategic alliance, alliance learning process, entrepreneurial orientation, alliance performance.*

JEL Classifications: D74, L25

INTRODUCTION

The construction sector is a high-risk business because it involves large investment value with high safety standards. On the other hand, tight competition forces the business to



compete with low cost and new technology so that they can win the competition in various ways. One of the strategies to win the competition is through distribution of risks. Construction company may work together with several other companies in its supply chain, and make them as subcontractors (Chung and Ng, 2006).

Companies need a variety of resources and the ability to compete effectively. Resources and capabilities can be obtained through the acquisition, developed internally or by establishing cooperative relationships with other companies through strategic alliances (Mudambi & Tallman, 2010; Bierly & Gallagher, 2007).

Strategic Alliance has risen significantly over the last decade and is very effective in helping a company to maintain its competitive advantage in a dynamic environment. Alliances allow companies to focus on their core competencies, which is a combination of unique resource and capability to produce excellence and rely on major alliance partners to perform other tasks (Bierly & Gallagher, 2007). Alliances can also increase the company's strategic flexibility, because the company only needs to allocate fewer resources to a project and can allocate other resources in the different activities. In addition, the strategic alliance may provide sources of competitive advantage for the company, such as access to complementary technologies, access to new markets and risk reduction (Bierly & Gallagher, 2007).

In the resource-based view theory, Barney (1991) explains that the company's resources include all assets, capabilities, processes that occur within the organization, the company attributes, information, knowledge, that can be controlled by the company to be used as a strategy to achieve efficiency and organizational effectiveness. Furthermore, Barney (1991) states that the resource is the company's power that can be used to understand and implement corporate strategies, including strategic alliances. Resources are classified by Barney into three categories: 1) physical capital, which includes the technology that is used by the company, plant and equipment, geographical location, and access to raw materials; 2) human capital, which includes training, experience, intelligence decisions, and relationship; 3) organizational capital which includes the formal reporting structure built by the company, corporate planning (both formal and informal), coordination and control system, and company's networking relationships.



By integrating the perspective of resource-based view (Barney, 1991; Dierickx and Cool, 1989) with the perspective of economic transaction costs (Williamson, 1989), dynamic capabilities (Teece, Pisano, and Shuen, 1997; Zollo and Winter, 2002; Eisenhardt and Martin, 2000; Helfat, 2007) and organizational learning theory (Huber, 1991), as well as the knowledge-based view of the firm (Kogut & Zander, 1992; Nonaka, 1994; Grant, 1996), researchers in the field of strategic management start to develop the concept of strategic alliance (Dyer, Kale & Singh, 2001; Flatten, Isabell, Brettel, 2011; Chen & Chen, 2002; Kale and Singh, 2007, Das, Sen and Sengupta, 1998, Mudambi & Tallman, 2010; Emden, Yaprak & Cavusgil, 2005).

Strategic Alliance is a relationship that is deliberately constructed between two or more independent companies with activities involving exchange, sharing, or co-development of the resources or capabilities to achieve mutual benefits (Gulati, 1995). A strategic alliance can be formed by developing one or more value chains, and has a variety of configuration organizations that are based on the inclusion of equity in the relationship, such as a joint venture which is one kind of partnership based on equity-based or investment (Kale & Singh, 2009).

However, according to Yoshino & Rangan (1995), an alliance does not only include the cooperation based on equity but can also be based on contractual arrangements, such as cooperation in research and development of a product, the cooperation within the supply chain in manufacturing, the cooperation in the field of marketing, or mutually beneficial cooperation for the complementary assets or complementary expertise in a particular project.

One basic premise of the strategic alliance is that firms should concentrate on internal strategic activities that are important to them, and the things in which they are able to generate a sustainable competitive advantage; while other activities can be outsourced to companies with specific expertise or a company that has a focus on these activities, which can offer the economic of scale, as well as the benefits of a wider organizational learning (Venkatesan, 1992). This premise refers to the viewpoint of economic transaction costs (Williamson, 1989), whereby the company uses alliances to reduce the risks and costs (Franco & Haase, 2015).



The success of alliances of construction companies may also be affected by entrepreneurial orientation that can change habits in running operations, and minimizing organization inertia by building initiative, increasing the willingness to take risks and be more proactive (Siren et al., 2016). A common problem of the alliance in the construction sector is the slow work that results in rising costs. This happens because there are many companies involved in the construction project with lack of coordination. Beside coordination problem, errors are often repeated from one project to another.

The alliance is a reliable strategy to achieve competitive advantage in a dynamic environment (Bierly & Gallaher, 2007), however it is not easy to have a successful alliance. For that purpose, we need to understand how learning occurs in a successful alliance and how entrepreneurial orientation will address the problem of inertia so that routine that is so embedded in the company as well as a rigid structure will not hinder the learning process.

Previous research find that the alliance experience and dedicated function alliance are the factors that influence the success of the alliance, as well as the learning process of articulation, codification, sharing knowledge and internalization (Kale & Singh, 2007). This research focuses on the influence of learning process on the success of the alliance. Other studies on alliances also find that to reduce the influence of inertia in the process of learning, the alliances should also pay attention to entrepreneurial orientation to optimize the company's ability.

The remainder of the paper is organized as follows. Literature review is presented in Section 2, research methodology is Section 3, results and discussion in Section 4, and conclusions in Section 5.

LITERATURE REVIEW

Strategic Alliance

According to Yoshino & Rangan (1995), strategic alliance is a trading partnership that can enhance the effectiveness of the competitive strategies of the participating companies in cooperation, mutually beneficial trade for technology development by making use of the skills or products owned. Yoshino & Rangan (1995) also provides an overview of the various



kinds of relationships among companies that can be categorized based on contractual agreements into two broad categories, namely traditional contract (contract of sale, franchising, licensing, cross-licensing) and non-traditional contract partnership (joint R & D, joint manufacturing, joint marketing, mutually complementary assets and skills). The second category is based on equity agreement which can be divided into no creation of a new firm (minority equity investment, equity swaps) and the creation of separate entity (a joint venture, a 50-50 joint venture, unequal joint venture), and the dissolution of the entity (merger or acquisition). The diagram is attached in Appendix 1.

The structure of an organization that uses its bilateral alliances and settings can be viewed in two perspectives. First as a structural relationship (business transactions), and second as hierarchical relationships between the companies involved in the supply chain. By using the alliance, companies can reduce the costs associated with the negotiation, coordination, and monitoring of inter-company transactions and corporate governance (Williamson, 1989).

The Alliance will add values in the long term (cannot be expected to provide benefits in the short term). Kogut (1988) and Jarillo (1989) show that companies enter alliance cooperation arrangements for long-term strategic considerations, without taking into account the costs that results in the short term. However, this long-term strategic advantage should create value for shareholders that are readable by stock market participants. Thus, investors will react positively to the announcement of the strategic alliance undertaken.

Alliance Learning Process

Research with an emphasis on the role of learning process to build alliance capability is carried out by Kale and Singh (2007). This study is based on a perspective view of a company's knowledge base, indicating that organizations can improve their skills in managing tasks assigned to gather and apply knowledge that is relevant to the task. Here, the company conducts alliance learning process by applying four process (the articulation of knowledge, codification of knowledge, sharing of knowledge and the internalization of knowledge). With these activities, the company studies, accumulates and spreads the



influence of alliance management knowledge gained through experience of their own alliance, as well as from others.

In this concept, the manager of the company in alliance serves as a main storage of important experiences of alliance management as well as knowledge gained from the experience of previous alliances or alliances that are being made at that time. Companies can take measurement to help individual managers in alliance to articulate their knowledge of alliance management. Thus, the company capture and externalize the necessary alliance knowledge, so that other managers in the company can learn from these experiences (Kale & Singh, 2009).

A company can go a step further by arranging the accumulated knowledge of alliance management in the form of knowledge object that can be used also by others, such as alliance management guidelines, checklists, and manuals, which incorporate best practices for managing different phases and decisions in alliance life cycle. Hewlett-Packard and Eli Lilly are some companies that adopt this mechanism; they develop codification tools and templates to help managers assessing the suitability of a prospective alliance partners, developing an alliance agreement, assessing the performance of the alliance, etc. Codification process of alliances facilitate the replication and transfer of best practice within the company by creating a toolkit for managers.

It is important to note, that it is not impossible to perform articulation or codification of the entire know-how, especially knowledge that are tacit (not explicit) or personal in nature (Winter, 1987). Companies can affect the alliance know-how by conducting the process of knowledge sharing to exchange tacit knowledge and individual knowledge (possessed by each manager in the alliance) so that they can be spread throughout the organization. They can be in the form of group or personal interactions in the alliance committee, task forces or a special forum for the exchange of experience and best practice among managers in the alliance (Draulans, fever, and Volberda, 2003; Kale and Singh, 2007; Kale & Singh, 2009).

The fourth process that needs to be done in this learning process is to internalize and absorb the relevant knowledge of alliance management in various parts of the company through formal and informal means. This internalization process emphasizes on whether tasks



are associated with a particular alliance, and the process of apprenticeship, where a new manager will work with an experienced manager in the alliance to gain useful knowledge. Alternatively, the companies send their managers to a formal alliance training program conducted by the company internally or by external parties (Kale & Singh, 2009).

Siren et al. (2016) propose the concept that is in line with the concept of alliance learning process of Kale & Sing (2007) that associates the success of alliances with strategic learning, which is adaptive, long term, that allows organizations to break the bond of the strategic path that they usually have and by renewing their core capability. Strategic learning is not just learning from other companies' mistakes (Anderson et al., 2009; Covin et al., 2006; Green et al., 2008 ; Mueller et al., 2012), but also by building a model of strategic learning (Crossan et al., 1999; Kuwada, 1998; Thomas et al., 2001). They suggest that learning is based on four strategic set of capabilities that support an enterprise by making strategic adjustments through knowledge creation, knowledge dissemination, knowledge interpretation and knowledge implementation.

Furthermore, Siren et al. (2016) explain that the strategic acquisition of knowledge is a process of exploration that allows individuals within an organization to gather strategic information from their environment to expand their current knowledge. Processes performed by the individual and his/her group provide knowledge of new markets to the company as a fuel for the process of knowledge creation and increase the stock of existing knowledge. They also encourage knowledge creation and the company's ability to understand and anticipate external changes and to develop the knowledge base necessary to advance strategic change.

According to Siren et al., 2016, strategic knowledge dissemination is a social exchange process which refers to the sharing of strategic knowledge through interaction within and between organizational units in order to ensure that new ideas can permeate the entire organization. Dissemination of knowledge can take place both formally and informally and horizontally (between departments) and vertically (cross-functional) in the company. This process encourages and facilitates the transfer of knowledge within the enterprise and in the sub-units to maintain the diversity of views and to foster confidence in the company's internal and understanding among all functional areas, to orient them towards coordinated



innovation efforts. Meanwhile, in the process of interpretation, strategic knowledge organization members interpret new information about the potential opportunities through a process of mutual interaction in an open dialogue with people from different backgrounds and perspectives (Siren et al., 2016). In the process, companies need to consider the possibility of conflict of assumptions and different interpretations of the submitted information, so companies need to provide guidance in interpreting the information. Interpretation of knowledge enables the company to identify fragments of meaningful information and acts to find an alternative strategy. Siren et al., (2016) describes the implementation of the concept of strategic knowledge as a formal process to institute a new strategic knowledge of the aspects of human resources outside the organization, such as organizational systems, organizational structures, procedures, and routines. This concept is collectively referred as the organizational memory or storage system knowledge. In the knowledge implementation process, a variety of departments, groups and teams in organizations test the implementation of strategic initiatives. The most feasible initiative eventually becomes a formal strategy and generate new products, new services, or new processes.

Entrepreneurial Orientation (EO)

In the literature, Entrepreneurial Orientation (EO) is defined as the strategic posture of the company, which is an approach used by corporate leaders to implement power in the businesses to meet market needs today and for the future, which shows the innovativeness, risk-taking and proactiveness (Miller, 1983; Covin & Slevin, 1989). In particular, innovativeness is a tendency to create and introduce new products, new production processes, or new organizational system. Risk-taking is the tendency of companies to take a higher level of risk to try and venturing into previously unknown areas with a strong commitment, while proactiveness is the involvement in an opportunistic expansion to seize the opportunities for entering new markets and dealing with competitors (Li et al., 2017).

Literature of RBV find that internal resources of the company is the basis of competitive advantage (Barney, 1991), which in most studies, these resources are associated with Entrepreneurial Orientation (EO), and can be regarded as intangible resources embedded



in organization's routines and is spread among members of the organization (Hughes & Morgan, 2007; Lisbon, Skarmeas, and Saridakis, 2016, Li et al., 2017). Furthermore, the company cannot purchase EO from the market, but they have to invest a lot of time to cultivate the culture so that EO can be a source of sustainable competitive advantage (Lee, Lee, & Pennings, 2001; Li et al., 2017).

The level of entrepreneurial orientation (EO) is higher when companies are more open to interact with the external environment, thereby improving the ability to obtain knowledge-based resources that leads to a higher level of learning. Likewise, the tendency of companies showing a higher level of EO is to experiment with combining new resources, thereby facilitating the internalization of knowledge-based resources that will result in increased level of experiential learning (Kreiser, 2011).

Companies can increase the level of EO to produce high performance when they are involved in the alliances. When a company enters into a certain alliance, EO will help the alliance to understand the learning process and opportunities to look for resources in collaboration (Sarkar et al., 2001; Teng, 2007; Li et al., 2017).

Compared to conservative firms, companies with high level of EO tend to have a better understanding of the importance of resources contributed by all alliance partners. The company may identify the entrepreneurial process and procedures that are effective to manage complex resource integration activities with uncertain outcomes (Li et al., 2017). They can also develop their superior resource management capabilities through the entrepreneurial learning process (Politis, 2005; Ravasia & Turati, 2005; Li et al., 2017), which will increase the yield of the alliance as a whole. In particular, corporate alliances with innovative ideas may have more insights into the creative aspect and can produce promising ideas and new ways of thinking (Avlonitis & Salavou, 2007). Innovative companies tend to favor the renewal, creation and introduction of appropriate cooperative mechanisms in the alliance, which facilitate more effective control over the process of resource integration. In this way, innovation achieves a competitive advantage for the formed alliance as well as for all companies involved (Lambe, Spekman, & Hunt, 2002; Schilke & Goerzen, 2010; Li et al., 2017).



Conversely, when a company with a low level of EO is involved in the alliance, they may be more concerned with protecting their own resources rather than to provide sufficient resources to share (Teng, 2007). This will hinder the opportunity to integrate resources in the alliance, which in turn can undermine its success (Li et al., 2017). Based on the resource-based arguments, we propose that a strong EO is positively associated with the success of the alliance.

According to Siren et al. (2016), entrepreneurial orientation is needed to overcome the problem of inertia, routines that are so ingrained in the company as well as a rigid structure which will cause a significant threat to the adaptability of the company in the long term. Companies that have high level of entrepreneurship are considered as better equipped to adapt to a dynamic competitive environment.

METHODOLOGY

Research Questions

As indicated in the introduction, we have three major research questions. First is to find out how far alliance learning process influences the alliance performance. Second, whether the entrepreneurial orientation also has a positive influence on alliance performance. Lastly, whether cooperation of the relationship improves the positive relationship between entrepreneurial orientation and alliance performance.

Research Model

This research model is an adaptation of the measurement of the effect of learning alliance performance against performance conducted by Kale & Sing (2007) and the measurement of the effect of entrepreneurial orientation on alliance performance conducted by Li et al. (2017). The proposed research model is depicted in Figure 1.



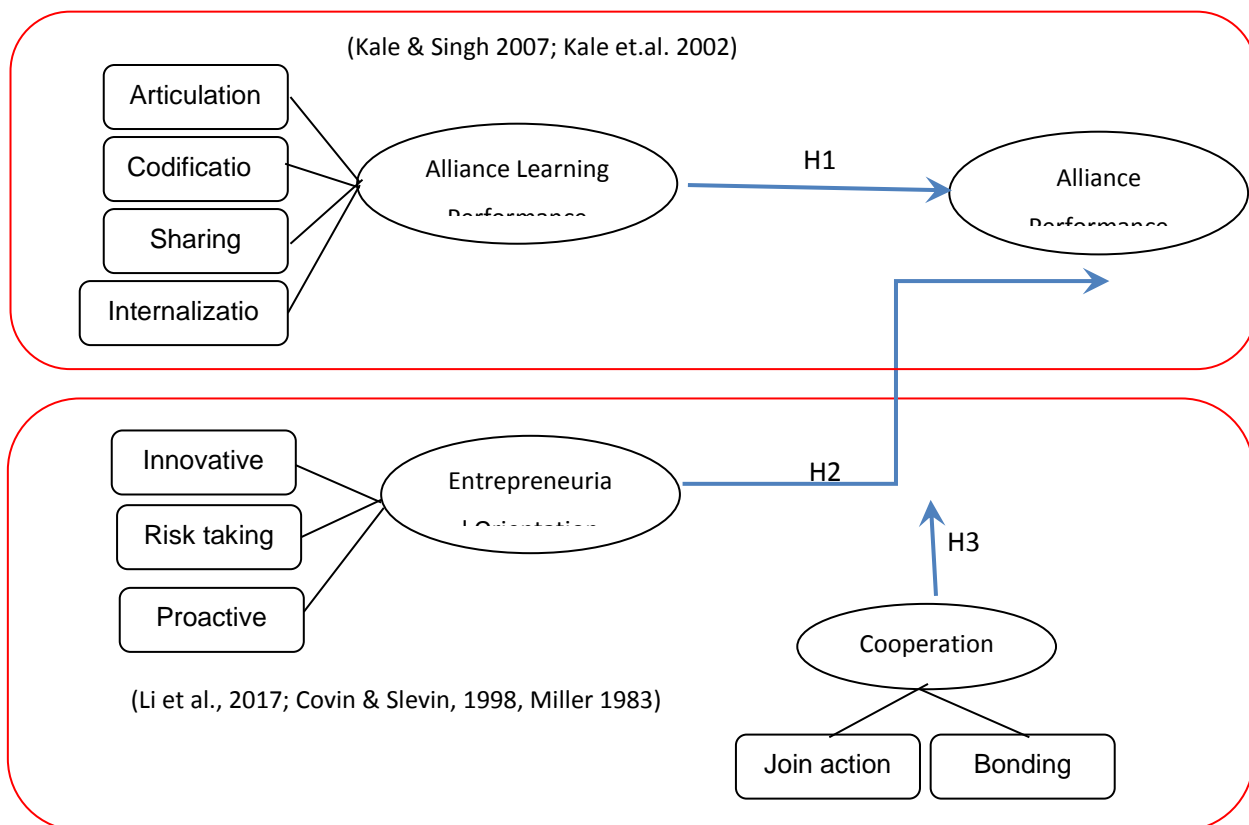

Figure 1. The proposed research model

Based on the explanation in Section2, we draw the following hypotheses:

- H1:** Alliance learning performance has a positive influence on alliance performance
H2: Entrepreneurial orientation has a positive influence on alliance performance
H3: Cooperation in the alliance moderate the relationship between entrepreneurial orientation and alliance performance.

Data

This paper presents is a preliminary stage of our research. This study use survey to gather primary data. In the pretest, questionnaires are distributed to 10 respondents with the same qualifications. We also interview all respondents to collect information on the issues of interest. This pretest is important for further research, to get feedback of questions posed in the questionnaire and to ensure that the respondents understand the questions as expected by the researchers.

In order to determine the sample in this study, we first identify Construction Company which has conducted strategic alliances in their businesses or cooperation with other companies in a specific time to work on a particular project. The objective of forming alliance may be varied, such as to obtain complementary expertise in marketing, distribution and production of raw materials. Then, we identify the right person for respondents based on two criteria: 1) the person must be responsible for the alliance management such as the project director, project manager, manager of corporate development, or team coordinator for certain alliance project and 2) the person has the ability to answer the questionnaire.

RESULTS AND DISCUSSION

Kale & Singh (2007) explain that each aspect of the alliance learning process is somewhat distinct, in terms of how it facilitates the learning and leveraging of alliance management know-how within a firm, and leads to greater alliance success. At the same time, each aspect is commonly directed toward the learning and accumulation of alliance management know-how. Hence, they are likely to be correlated with each other, and represent different facets of the alliance learning process. Thus, we used confirmatory factor analysis to estimate a second-order factor model that best represents these relationships. The four aspects of knowledge articulation, codification, sharing, and internalization represent first-order factors; and the alliance learning process represents the broader, second-order factor that commonly underlies all of them.

Our finding shows that construction companies in Indonesia that make alliances that they call consortium or join operation action, always have dedicated teams that monitor the projects day by day. This team consists of representatives from all companies involved in the alliance and lead by a consortium leader that is appointed by top management team of each company.

All respondents admit that their company's main reason to form alliances is to solve the problem of capital in the project as well as to obtain complementary capabilities. Thus, the company can expand by exploiting broader business opportunities through knowledge development, and increasing the capability of their experts. The company is also aware of potential conflict that can be occurred in the alliance, so that they anticipate the conflict by



preparing specific standard operating procedure and details of division tasks among companies in the consortium.

This finding provides useful implications for alliance managers regarding how to best utilize their entrepreneurial orientation and their relationships with partners to maximize the performance of the alliance. First, our findings indicate that companies can achieve success by adopting entrepreneurial orientation in alliance. Practitioners must recognize the importance of entrepreneurial orientation in managing alliances especially in breaking the routines in the company, so that they can expand broader business opportunities through proactiveness, risk taking and innovation.

The results of the study by Li et al. (2017) reinforce the belief that companies that have a strong entrepreneurial orientation tend to be better at finding opportunities through alliances. Therefore, to achieve superior performance of the alliance, the manager needs to take steps to encourage efforts to bring an entrepreneurial attitude in every action and develop entrepreneurial orientation to encourage companies to take action out of the routine and improve their innovative capabilities. Entrepreneurial orientation will also bring access to market, and thus, in the long term will increase the success of the alliance.

Understanding the value of contingent relationship between the alliance partners should help managers to better understand how to apply entrepreneurial behavior in their alliance partnerships. In particular, the joint action may be necessary for any company, but especially those with high entrepreneurial orientation in order to realize the success of the alliance by having diverse ideas, resources, and information provided by the collective activity. This means that the companies in the alliance should strengthen the level of joint action. For instance, they can foster an atmosphere that inspires a higher joint action through breeding expectancy greater continuity of future exchanges and encourages more specific investments (Heide and John, 1990). However, the company must be very careful not to rely on alliance bond as the bonding makes it more difficult for entrepreneurial orientation to develop and hence, may affect the success of the alliance. The close ties may lead to over-embedded and lock-in problem, and as a result, the relationship characterized by a high level of joint actions and bonding may hinder companies from pursuing entrepreneurial opportunities in the alliance.



CONCLUSIONS AND RECOMMENDATIONS

This study presents the preliminary results with a very small sample size. Measurement model uses confirmatory factor analysis to assess validity and reliability of the scales that is used to measure the constructs, whereas the structural model estimates strength and direction of relationships between them (Hair et al., 1998)

Table 1. Result of Validity and Reliability test

	APL - A	APL - C	APL - S	APL - I	AP	EO	CO
Validity Test							
KMO	0,861	0,725	0,707	0,689	0,614	0,584	0,607
Barlett's Test - sign	0,000	0,000	0,001	0,000	0,001	0,000	0,005
Reliability Test							
Cronbach's Alpha	0,909	0,808	0,739	0,868	0,771	0,852	0,787

The results of validity and reliability test that is shown in table 1, give us information that this questioner valid and reliable to measure all variable and dimension in this study. Out of 40 question items, 9 items have a loading factor <0.5 . Thus we have to improve wording from those 9 question.

In the next step, we intend to increase the number of respondents to be close to 100 respondents. Thus, the analysis will be more meaningful and beneficial for the construction companies in Indonesia.

REFERENCES

- Anand, B.N. & Khanna, T. (2000). Do firms learn to create value? The case of alliances. *Strategic Management Journal*, 21, 295 – 315.
- Bierly, Paul E.III & Gallagher, Scott. (2007). Explaining alliance partner selection: Fit, trust and strategic expediency. *Long Range Planning*, 40, 134 – 153.
- Bouncken, R. B. & Fredrich, V. (2016). Learning in coopetition: Alliance orientation, network size, and firm types. *Journal of Business Research*, 69, 1753–1758.



- Das, Sen & Sengupta (1998). Impact of Strategic Alliances on Firm Valuation. *The Academy of Management Journal*, 41, 27-41.
- Emden, Yaprak, & Cavusgil. (2005). Learning from experience in international alliances: antecedents and firm performance implications. *Journal of Business Research*, 58, 883– 892.
- Flatten, Greve & Brettel. (2011). Absorptive Capacity and Firm Performance in SMEs: The Mediating Influence of Strategic Alliances. *European Management Review*, 8, 137– 152.
- Hampson, Keith D. and Kwok, Tommy (1997) Strategic alliances in building construction: a tender evaluation tool for the public sector. *Journal of Construction Procurement*, 3(1). pp. 28-41.
- Jiang, X., Yang, Y., Pei, Y., & Wang, G. (2016). Entrepreneurial orientation, strategic alliance, and firm performance: Inside the black box. *Long Range Planning*, 49, 103-116.
- Kale, P., Dyer, J.H., & Singh, H. (2002). Alliance capability, stock market response, and long-term alliance success: The role of the alliance function. *Strategic Management Journal*, 23, 737 – 767.
- Kale, Prashant & Singh, Harbir. (2007). Building Firm Capabilities Through Learning: The Role Of The Alliance Learning Process In Alliance capability And Firm-Level Alliance Success. *Strategic Management Journal*, 28, 981–1000
- Kale, Prashant & Singh, Harbir. (2009). Managing strategic alliances: What do we know now, and where do we go from here? *Academy of Management Perspective*.
- Kaupila, Olli-Pekka. (2015). Alliance management capability and firm performance: Using Resource-based theory to look inside the process black box. *Long Range Planning*, 48, 151-167.
- Khalid, S. & Larimo, J. (2012). Affects of alliance entrepreneurship on common vision, alliance capability and alliance performance. *International Business Review*, 21, 891-905.
- Kreiser, Patrick M. (2011). Entrepreneurial orientation and organizational learning: the impact of network range and network closure. *Entrepreneurship Theory And Practice*.



- Li, L., Jiang, F., Pei, Y., Jiang, N. (2017). Entrepreneurial orientation and strategic alliance success: The contingency role of relational factor. *Journal of Business Research*, 72, 46-56.
- Luo, Yadong. (2008). Procedural Fairness and Interfirm Cooperation in Strategic Alliances. *Strategic Management Journal*, 29, 27-46.
- Mudambi, Susan M. and Tallman, Stephen. (2010). Make, Buy or Ally? Theoretical Perspectives on Knowledge Process Outsourcing through alliances. *Journal of Management Studies*, 47:8.
- Nielsen, Eva & Jolink, Albert. (2014). The Impact of Alliance Management Capabilities on Alliance Attributes and Performance: A Literature Review *International Journal of Management Reviews*.
- Bierly III, Paul E. & Gallagher, Scott. (2007). Explaining Alliance Partner Selection: Fit, Trust and Strategic Expediency. *Long Range Planning*, 40, 134-153
- Sciascia, S., D’Oria, L., Bruni, M., Larraneta, B. (2014). Entrepreneurial orientation in low and medium tech industries : the need for absorptive capacity to increase performance. *European Management Journal*, 32, 761-769.
- Siren, C., Hakala, H., Wincent, J., Grichnik, D. (2016). Breaking the Routines: Entrepreneurial Orientation, Strategic Learning, Firm Size, and Age. *Long Range Planning*.
- Covin, Jeffrey G. & Slevin, Dennis P. (1989). Strategic management of small firms in hostile and benign environments. *Strategic Management Journal*, Vol. 10, 75-87.
- Wu, Fang & Cavusgil, S. Tamer. (2006). Organizational learning, commitment, and joint value creation in interfirm relationships. *Journal of Business Research*, 59, 81 – 89.
- Wang, Y., Chen, Y. , Fu, Y., Zhang, W. (2017). Do prior interactions breed cooperation in construction projects? The mediating role of contracts. *International Journal of Project Management*, 35, 633–646.
- Alezander, Hilda B. (2017, Februari 10). Sektor konstruksi penyumbang ketiga pertumbuhan ekonomi nasional..
- Peraturan Menteri Nomor: 08/PRT/M/2011 tanggal 13 Juni 2011
- Undang-Undang Republik Indonesia Nomor 2 tahun 2017 Tentang Jasa Konstruksi



Appendix 1

Scope of Inter-firm Relationship that can be categorized as strategic alliance (sumber: Yoshino & Rangan, 1995)

Appendix 2 – Research Questioners

Bapak/ Ibu Responden yang terhormat,

Perkenalkan saya Retno Handayani, mahasiswa pascasarjana Fakultas Ekonomi dan Bisnis Universitas Indonesia untuk Program Studi Corporate Strategic Management, yang sedang mengadakan penelitian tentang “Pengaruh dari entrepreneurial orientation dan alliance learning process terhadap kinerja aliansi perusahaan sektor konstruksi di Indonesia”.

Adapun yang kami maksud dengan aliansi disini adalah suatu hubungan yang sengaja dibangun antara dua atau lebih perusahaan independen dengan melibatkan kegiatan pertukaran untuk saling melengkapi, saling berbagi ataupun pengembangan bersama dari sumber daya (resource) ataupun kemampuan (capabilities) yang dimiliki untuk mencapai manfaat bersama.

Terkait dengan hal diatas, saya mohon kesediaan Bapak/ Ibu untuk berpartisipasi dalam survei yang dilakukan dengan menjawab pertanyaan kuesioner secara akurat dan sesuai pengalaman Bapak/ Ibu. Setiap informasi yang diperoleh dari kuesioner ini murni hanya akan digunakan untuk tujuan akademis dan tidak berpengaruh apapun terhadap responden. Kami menjamin kerahasiaan dari informasi yang diberikan.

Atas kesediaan Bapak/ Ibu, kami ucapkan terima kasih.

Hormat saya,

Retno Handayani

Pertanyaan Pendahuluan



A. Identitas Perusahaan

1. Nama Perusahaan _____
2. Usia perusahaan (pilih salah satu)
 - a. Dibawah 5 tahun
 - b. Antara 5 – 10 tahun
 - c. Antara 10 – 15 tahun
 - d. Antara 15 – 20 tahun
 - e. Antara 20 – 25 tahun
 - f. Lebih dari 25 tahun
3. Jenis perusahaan (pilih salah satu)
 - a. BUMN
 - b. Swasta Nasional
 - c. Swasta Asing
4. Ukuran perusahaan berdasarkan Kualifikasi usaha Jasa Konstruksi
 - a. K 1
 - b. K 2
 - c. K 3
 - d. M 1
 - e. M 2
 - f. B 1
 - g. B 2
5. Jumlah karyawan
 - a. Kurang dari 100 orang
 - b. Antara 100 – 300 orang
 - c. Lebih dari 300 orang



B. Identitas Responden

1. Initial responden _____
2. Jenis kelamin (pilih salah satu)
 - a. Laki-laki
 - b. Perempuan
3. Usia responden (pilih salah satu)
 - a. Dibawah 30 tahun
 - b. Antara 30 – 35 tahun
 - c. Antara 35 – 40 tahun
 - d. Antara 40 – 45 tahun
 - e. Antara 45 – 50 tahun
 - f. Antara 50 – 55 tahun
 - g. Antara 55 – 60 tahun
 - h. Lebih dari 60 tahun
4. Masa kerja responden (pilih salah satu)
 - a. Dibawah 5 tahun
 - b. Antara 5 – 10 tahun
 - c. Antara 10 – 15 tahun
 - d. Antara 15 – 20 tahun
 - e. Antara 20 – 25 tahun
 - f. Lebih dari 25 tahun
5. Jabatan fungsional responden _____



C. Pengalaman melakukan aliansi dalam proyek konstruksi

1. Apakah Anda pernah terlibat dalam Aliansi (suatu hubungan yang sengaja dibangun antara dua atau lebih perusahaan independen dengan melibatkan kegiatan pertukaran untuk saling melengkapi, saling berbagi ataupun pengembangan bersama dari sumber daya (resource) ataupun kemampuan (capabilities) yang dimiliki untuk mencapai manfaat bersama)? Ya / Tidak

2. Apakah ada tim khusus yang bertanggung jawab terhadap kerja sama yang dibuat dalam proyek Aliansi tersebut? Ya / Tidak

Pertanyaan Kuesioner

Seluruh pertanyaan dalam kuesioner ini menggunakan Skala Likert 1 sampai 5 dengan perincian sebagai berikut

1	Sangat tidak setuju (STS)
2	Tidak setuju (TS)
3	Agak tidak setuju (ATS)
4	Agak setuju (AS)
5	Setuju (S)
6	Sangat setuju (SS)

I. Alliance Learning Process

Sejauh mana Anda setuju atau tidak setuju dengan pernyataan yang berhubungan dengan praktik aliansi berikut ini

I. Alliance Learning Process (Kale & Singh, 2007) – Artikulasi Pengetahuan		STS	TS	ATS	AS	S	SS
1	Manajer yang terlibat dengan aliansi, secara teratur diminta perusahaan untuk melakukan presentasi dan sesi tanya jawab tentang pengalaman aliansi mereka yang masih berjalan saat itu ataupun yang sebelumnya.	1	2	3	4	5	6
2	Manajer yang bertanggung jawab terhadap aliansi perusahaan memiliki catatan (dalam bentuk memo, catatan, laporan, atau presentasi) dari semua insiden, keputusan, atau	1	2	3	4	5	6



	tindakan penting yang terkait dengan aliansi masing-masing.						
3	Manajer aliansi rutin melaporkan kemajuan dan kinerja aliansi masing-masing.	1	2	3	4	5	6
4	Perusahaan kami mempertahankan 'repositori' atau database yang berisi informasi faktual dari masing-masing aliansi-nya (misalnya, tanggal dan tujuan pembentukan aliansi, nama mitra aliansi, nama-nama manajer / eksekutif yang mengelola aliansi, dll).	1	2	3	4	5	6
5	Perusahaan kami menyimpan direktori atau 'daftar kontak' individu dari dalam perusahaan atau dari luar perusahaan yang berpotensi untuk dapat memberikan masukan atau bantuan terkait manajemen aliansi.	1	2	3	4	5	6

I. Alliance Learning Process (Kale & Singh, 2007) – Kodifikasi Pengetahuan		STS	TS	ATS	AS	S	SS
1	Manajer perusahaan mengikuti proses yang dipersiapkan dengan baik pada pembentukan manajemen aliansi.	1	2	3	4	5	6
2	Sumber daya seperti <i>check list</i> atau pedoman dikembangkan dan dimanfaatkan untuk membantu pengambilan keputusan dan tindakan manajerial ketika membentuk atau mengelola aliansi strategik.	1	2	3	4	5	6
3	Sumber daya seperti panduan/ manual aliansi (berisi peralatan, template, atau kerangka kerja) dikembangkan dan digunakan untuk membantu pengambilan keputusan dan / atau tindakan manajerial ketika membentuk atau mengelola aliansi.	1	2	3	4	5	6
4	Perusahaan kami terus memperbaharui <i>check list</i> , pedoman ataupun manual aliansi yang telah dikembangkan dan digunakan.	1	2	3	4	5	6

I. Alliance Learning Process (Kale & Singh, 2007) – Berbagi Pengetahuan		STS	TS	ATS	AS	S	SS
1	Manajemen perusahaan melakukan sebuah 'review kolektif' untuk menilai kemajuan dan kinerja aliansi strategik.	1	2	3	4	5	6
2	Manajer aliansi berpartisipasi dalam forum seperti komite atau gugus tugas (task force) untuk menginventarisir pengalaman dan manajemen aliansi.	1	2	3	4	5	6
3	Manajer perusahaan berpartisipasi dalam forum seperti rapat, seminar, atau retreat untuk saling bertukar informasi,	1	2	3	4	5	6



	pengalaman, ataupun cerita penting yang terkait aliansi.						
	I. Alliance Learning Process (Kale & Singh, 2007) – Berbagi Pengetahuan	STS	TS	ATS	AS	S	SS
4	Manajer perusahaan terlibat dalam kegiatan berbagi dan bertukar informasi ataupun pengetahuan yang terkait aliansi secara informal dengan rekan kerja maupun mitra kerja (partner) dalam organisasi aliansi.	1	2	3	4	5	6
5	Manajer dengan pengalaman substansial dalam mengelola aliansi sebelumnya biasanya dirotasi di beberapa aliansi utama perusahaan.	1	2	3	4	5	6
6	Insentif manajerial digunakan untuk mendorong manajer untuk berbagi pengalaman pribadi maupun pengetahuan implisit mereka yang terkait manajemen aliansi dengan manajer lain dalam perusahaan.	1	2	3	4	5	6

	I. Alliance Learning Process (Kale & Singh, 2007) – Internalisasi Pengetahuan	STS	TS	ATS	AS	S	SS
1	Manajer perusahaan menghadiri program pelatihan internal tentang manajemen aliansi setiap kali mereka ditugaskan untuk mengelola atau bekerja dengan suatu aliansi.	1	2	3	4	5	6
2	Manajer perusahaan menghadiri program pelatihan eksternal tentang manajemen aliansi setiap kali mereka ditugaskan untuk mengelola atau bekerja dengan aliansi tertentu.	1	2	3	4	5	6
3	Perusahaan kami memberikan kesempatan untuk pelatihan 'on-the-job' untuk individu yang relatif baru dalam mengelola aliansi (individu ditugaskan untuk bekerja di aliansi yang ada bersama dengan manajer yang telah memiliki pengalaman substansial dalam mengelola aliansi tersebut).	1	2	3	4	5	6
4	Perusahaan kami menyediakan akses kepada manajer untuk mendapatkan dokumen dan informasi yang telah dikodifikasi serta pengetahuan dari pengalaman aliansi sebelumnya maupun dari aliansi yang sedang berjalan.	1	2	3	4	5	6

II. Alliance Performance



II. Alliance Performance (Kale & Singh, 2007; Kale et al., 2002; Li et al., 2017)		STS	TS	ATS	AS	S	SS
1	Aliansi ini memiliki hubungan yang kuat dan harmonis antara mitra aliansi.	1	2	3	4	5	6
2	Perusahaan kami telah mencapai tujuan utamanya melalui pembentukan aliansi.	1	2	3	4	5	6
3	Posisi kompetitif perusahaan kami telah sangat meningkat karena adanya aliansi.	1	2	3	4	5	6
4	Perusahaan kami telah berhasil dalam mempelajari beberapa keterampilan ataupun kemampuan penting dari mitra aliansinya	1	2	3	4	5	6
5	Perusahaan kami puas dengan kinerja aliansi.	1	2	3	4	5	6



III. Entrepreneurial Orientation

Sejauh mana Anda setuju atau tidak setuju dengan pernyataan yang berhubungan dengan orientasi kewirausahaan dan kerjasama berikut ini

III. Entrepreneurial Orientation (Li et al. ,2017)		STS	TS	ATS	AS	S	SS
1	Secara umum, perusahaan kami lebih menekankan pada penelitian dan pengembangan, kemajuan teknologi, dan inovasi	1	2	3	4	5	6
2	Perusahaan kami menyukai prosedur, sistem, dan metode yang sudah teruji dan berhasil sebelumnya.	1	2	3	4	5	6
3	Perusahaan kami bersedia untuk mencoba cara-cara baru dalam melakukan sesuatu dan berusaha mencari solusi baru yang tidak biasa dilakukan.	1	2	3	4	5	6
4	Perusahaan kami termasuk di antara perusahaan yang pertama memperkenalkan produk atau jasa baru di industri ini	1	2	3	4	5	6
5	Perusahaan kamilah yang selalu menginisiasi tindakan terhadap pesaing, baru kemudian pesaing merespon	1	2	3	4	5	6
6	Dalam kondisi ketidakpastian, perusahaan kami selalu menerapkan sikap aktif dan berani bertualang untuk mencoba hal baru.	1	2	3	4	5	6
7	Perusahaan kami memiliki preferensi yang kuat untuk proyek-proyek berisiko tinggi (dengan kemungkinan hasil yang sangat tinggi)	1	2	3	4	5	6
8	Karena karakteristik dari lingkungan, bisnisnya, perusahaan kami cenderung mengambil tindakan strategik yang berani dan bervariasi daripada membuat perubahan taktis yang minor.	1	2	3	4	5	6
9	Ketika dihadapkan dengan keputusan yang melibatkan ketidakpastian, perusahaan kami selalu mengadopsi tindakan berani untuk memaksimalkan probabilitas eksploitasi	1	2	3	4	5	6

I. IV. Cooperation (join action & bonding)

IV. Cooperation (join action & bonding) - (Li et al., 2017)		STS	TS	ATS	AS	S	SS
1	Kami bekerja sama dengan mitra aliansi dalam pengembangan ataupun perbaikan kualitas produk	1	2	3	4	5	6
2	Perusahaan kami bekerja sama dengan mitra aliansi dalam pelaksanaan proyek	1	2	3	4	5	6



3	Perusahaan kami bekerja sama dengan mitra aliansi dalam hal aktivitas penjualan	1	2	3	4	5	6
4	Perusahaan kami bekerja sama dengan mitra aliansi dalam hal <i>maintenance & support</i>	1	2	3	4	5	6
5	Perusahaan kami memiliki ikatan yang erat dengan mitra aliansi.	1	2	3	4	5	6
6	Jika perusahaan kami memutuskan hubungan dengan mitra aliansi ini maka perusahaan akan kehilangan teman bisnis yang baik	1	2	3	4	5	6
7	Perusahaan kami memiliki hubungan sosial yang baik dengan mitra aliansi ini.	1	2	3	4	5	6



**THE EFFECT OF INNOVATION TO ORGANIZATION PERFORMANCE AT
CULINARY INDUSTRY ON BRAGA DISTRICT**

Laura Lahindah

Harapan Bangsa Business School Bandung Indonesia
laura@ithb.ac.id

Ady Widya Mitra

Equine Global Corp. Jakarta Indonesia
ady_widya@yahoo.com

Abstract

Culinary industry contributed around 25% to gross regional product domestic (GDP) in 2013. This condition proved that culinary having been become an identity and brand of the city, that we should keep preserve and evolve to improve Indonesia tourism. Braga is one of the heritage street in Bandung city, built with colonial architecture design. Braga has become a special place in people's own, to be a place for hanging out, the place for taking the picture, enjoying the old-building, and most of all culinary experience. This research conduct to 34 culinary along Braga street. Data show that 58% of the culinary industry in Braga district shows the percentage increase in profit year on year by more than 2.5%. That fact shows the good organizational performance of the culinary industry in Braga district. To achieve a good performance in the culinary industry, innovation playing important roles. This research analyzes the effect of innovation on organization performance. By using WarpPLS 3.0 with Structural Equation Model-Partial Least Square (SEM-PLS) method, we found that innovation simultaneously has an impact to organization performance in Braga district. But as partially innovation variables have not significantly effect to organization performance.

Keywords: *culinary, innovation, performance organization.*

JEL Classification: *L25, L66*



BACKGROUND

Culinary is one of the industry sectors that accounted for the biggest income for Indonesia. Culinary industry growth creating a major role in the national economy of the country. In 2013 the culinary sector giving around 25% contribution to the Indonesia Gross Regional domestic product (GDP). Culinary sector reached 25% or Rp 52.25 trillion from Rp 206 trillion of Indonesia GDP (Kompas.com, 2014).

Culinary is one of the creative economy sector (besides fashion, television, media, etc.) that should be developed as a superior product to become a tourism attraction as an identity of the city. In West Java the overall contribution of creative sector reached 40% of the total GDP of Rp 1,070 that is around Rp. 18 trillion. And the culinary industry is the biggest contributor is Rp 40 trillion, or 10% of the contribution (Pusat Data dan Analisa Pembangunan Jawa Barat, 2014).

To achieve a good performance in the culinary industry, innovation playing important roles. The roles of innovation in the industrial sectors closely related to the growth and development of world trends, changes in consumer behavior, purchase ability, and consumer educational background. Culinary industry dealing with the dynamic world market. Where they challenged to survive, grow and develop. Sometimes culinary also face contradictive conditions, the first condition shows that innovation can make them successfully achieve value, but in another side, innovation could bring a disaster even make a company nearly bankrupt. That conditions entirely was heavily influenced by the innovations they do.

According to the Mayor of Bandung Ridwan Kamil, Bandung visited by more than 6 million foreign tourists, and the numbers increase every year (Prasetyo, 2014). Bandung did have a proven attraction after elected to be the fourth city in Asia to be best foreign tourists after Bangkok, Seoul and Mumbai, whereas in the world ranked 21st (Metrotvnews.com, 2015). Bandung has an innovative culinary that became a tourist main attraction. Bandung is famous for its innovative food and beverages, because of its innovation on product innovation, process innovation, market innovation, to the raw material.

Based on the results of observation during the study, 58% of the culinary industry in Braga district Bandung shows the percentage increase in profit year on year by more than 2.5%. This increasing shows that the good performance of the organization of the culinary



industry in Braga district. This research tries to find how the performance of the culinary industry in Braga district increase. Four antecedent are used in this analysis. That are product innovation, process innovation, market innovation and raw material innovation

INNOVATION

Innovation emphasizing in some different aspects of the term. The first definition was coined by Schumpeter (1934). Schumpeter (1934) stresses the novelty aspect of innovations. Innovation is reflected in novel outputs: a new good or a new quality of a good, a new production method, a new market, a new supply source. It can be summarized as: 'doing things differently'. Innovation isn't always about the leadership undertaken by someone who brings a change in an organization or individual, innovation is also a challenge that should be done when there is an opportunity.

Hurley and Hult (1998) state that innovation is a mechanism of enterprises to adapt to the dynamic environment. Therefore, the company should be able to create new thoughts, new ideas by offering innovative products and services that can increase customer satisfaction. To be able to successfully survive in the long term, companies must be able to adapt, to satisfy or creating new markets, not only to satisfy a market that is already exists. Research proves that organizations that conduct strategic planning, has better performance than not. The selection of an appropriate strategy, between the environment organization with strategy, structure, and the process will bring a positive impact on the company's performance, especially in the midst of an increasingly dynamic market changes (Wheelen & Hunger, 2012).

Vries, Bekkers, & Tummers (2014) define innovation, as a result-oriented thinking to improve quality, with four (4) main elements, are:

1. The Innovation of process (process innovation), which focuses on improving the quality and efficiency of the internal and external processes in the company. Include how organizations make changes to the production process such as the use of automatic machines.
2. Product or service Innovation is the ability of the Organization to improve product design, features, and specifications according to the wishes of consumers or



improve the value of products and services by creating arrange of new products or services.

3. Market innovation, to develop new forms and processes in the Organization to gain new market share.
4. Supply source innovation, using a new raw material, or a new source of raw materials providers to improve the quality of products or services, as well as to improve the efficiency and effectiveness of the work.

Vries, Bekkers, & Tummers (2014), state that innovation as a new element in the form of knowledge, ability, governance of the Organization, or in the management systems, which improve or enhance the State of the past, in order to achieve the quality or better results.

ORGANIZATION PERFORMANCE

Helfert (2012) made the point that performance is the outcome or the overall success rate for a specific period of time in carrying out the task, compared to the target, the standard of work, or the given initial and target have been mutually agreed. The performance was not fully seen as a display of an accomplishment that is successful, it could be seen from some or in accordance with aspects of the review. Sriwati (2012) argues that performance is a general term used to indicate the part or all of the actions or activities of the Organization in a certain period, so that performance measurement into an act of measurement that can be exercised against a range of activities at the company.

In measure company performance, Kusumawati (2010) stated there are two approaches namely objective and subjective approaches. The objective is a type of approach by using the data objectively, namely in the form of financial accounting data, whereas the subjective approach is an approach to measure the performance of the company based on the perceptions of managers on performance of the company.

According to Abouzeedan (2011) in measuring organizational performance, can be used in two (2) parameters, namely:



1. Non-Financial Variables

Non-Financial Variables is a parameter of the performance measurement by looking at non-financial data, due to variables such as financial ratios fails to provide the appropriate assessment to measure the performance of the Organization, especially in the sector of small and medium enterprises. Then the age, and the size of the Organization, as well as the amount of assets can be used as a foundation to measure organizational performance. This opinion is supported by Abouzeedan (2011) that an asset can be a good indicator for measuring organization. Keasey and Watson using age as a non-financial variables, because sometimes the large amount of assets can be changed due to a change of strategy to increase profits by narrowing the focus of the market, but improving profits (Abouzeedan, 2011).

2. Financial Variables

Financial variables using financial data to measure the performance of the Organization, by comparing the financial performance per period of time. Financial or financial variables can certainly be shown how organizational performance, with respect to profits, assets, and cash flow statement, and balance sheet position as a comparison of the financial performance of the organization.

Abouzeedan (2011) often got challenges in measuring the performance of the organization. Because in practice to assess or measure organizational performance, particularly on small and medium enterprises, which do not have a profit leap, or other required financial variables used as parameters to measure the performance levels of an organization, likewise:

1. Model of performance measurement, quantitative or qualitative measurement model is expected to be a model of optimal organizational performance measurement.
2. In measuring performance, non-financial parameters (age, size of the organizations, brands, and more) is expected to be the size of the organization.
3. Diversity in organizations (business sector, size, age, culture) hope can become



part of the variable measurement organization. While attention to organizations that are still in the stage of ripening (new) not yet created stability, and tend to be dynamic, to follow trends and changes, than organizations that have matured (old).

4. The information is limited, in either side of the performance of employees, goods turnover, expected to facilitated performance measurement model.
5. Performance measurement method used to focus more on the quantitative results of the calculation based on statistical data, can now be done with more optimal organizational overview analyzes based on consideration of other factors, which are not statistically real or not can be calculated mathematically. So the measurement of organizational performance is expected to include a variety of factors, which are more up to date information regarding the organization confirms.

THE EFFECT OF INNOVATIONS TO ORGANIZATIONAL PERFORMANCE

Innovation can serve as one of the strategies to achieve competitive advantage. The main objective of innovation is to meet the market demand so that product innovation is one that can be used as a competitive advantage for the company (Supranoto, 2009). Innovation is a factor that adds value to the organization. Innovation can be done through strategy, behavior, as well as motivation and encouragement in performing various actions. Customers generally want innovative products in accordance with their need. For the company, its success in innovating means that company a step further than its competitors. It is demanding the company's cleverness in recognizing customer tastes so that innovation ultimately does indeed correspond to the wishes of its customers. Thus innovation must be well planned and done carefully.

Research by Supranoto (2009) found that innovation is an important factor to achieve competitive advantage. For the company, the success in creating competitive advantage is believed to be one of the ways to improve its performance. Furthermore, this research will examine the factors of innovation, as a factor that effects though organization to improve its performance. Four hypothesis are conduct to clarify the condition as below:



H₁: Product innovation have positive effect on performance of the Organization

H₂: Process innovation have positive effect on performance of the Organization

H₃: Market innovation have positive effect on performance of the Organization

H₄: Supply source innovation have positive effect on performance of the Organization

RESEARCH METHOD

This research will study how innovation effects the performance organization, how an organization can run properly, structured, and has the atmosphere of a positive environment, thereby encouraging the creation of innovation able to help organizations survive the challenges and grow over time. In support of the creation of the innovation, the role of a leader could not be separated, as the leader of a major milestone is to be observant in looking at opportunities, and make improvements, so that the organization can remain compete and grow.

Objects that become research is a culinary industry in Braga district, Bandung, by conducting a survey for data retrieval. Data on the Department of culture and tourism of Bandung city culinary venture grouping into three classification i.e. business restaurant, bar and cafe. Where the classification is drawn up on the basis of Regulation No. 797 of Bandung City Mayor in 2005 – about the categorization effort means tourism. This research focuses on innovation or done to increase or result in organizational performance. The techniques of observation, documentation, interviews and questionnaires will be conducted on the perpetrators of the originator or entrepreneur who doing innovation within the Organization (owner or manager).

This research uses the descriptive and verification method of approach to the survey, with data collection through questionnaire (question form), interview, observation, and documentation. Where descriptive format aimed at explaining, summarizing the various conditions, circumstances, also there are variables, while verification is the research aimed to verify the truth of the results of previous research. The survey approach is a method of research that aims to get a conclusion that can describe and explain an idea against the results of the verification of the sample being studied. Based on the results of the mapping, there are



80 culinary industry (restaurants, bars, cafés, and a bakery) in the village of Braga. And found 34 questionnaires valid to analyses.

DATA ANALYSING

In this study the data collected from the survey results, interviews, documentation, and observations will be analyzed by multiple linear regression with the SEM-PLS, using the WarpPLS 3.0 program. To test product innovation, process innovation, market innovation, and supply source innovation as independent variable and organization performance as a dependent variable. Also finding the result of model fit, a standard of errors, composite reliability, cronbach's alpha and effect size.

The value of fit is a result of the calculations to analyze the average path's (APC), the average R-squared (ARS), and average variance inflation (AVIF). The value of p for APC and ARS should be smaller than 0.05 significant meaning. In addition, the AVIF as an indicator of multi-linearity should be less than 5. The output shows the results of the goodness of fit criteria model is: APC at 0.212, with p-value 0.008, ARS at 0.435, with p-value 0.254, and AVIF at 1.763. From these data were obtained that the APC and the ARS have values of p greater than 0.001 but AVIF values meet the criteria with 1.763 (less than 5). Interpretation of the indicator model fit depending on the purpose of the analysis of SEM. If the goal is only hypothesis testing relations between latent variables, then the indicator model fit became less important. However, when our goals determine the best model of several models then the goodness of fit to be very important (Sholihin & Ratmono, 2013).

Standard errors are required if you want to test the influence of mediation for a linear relationship. While the effect size is the absolute value of the contribution of each variable per-indicator on the latent value of R-squared variable criterion. Each variable have standard of errors, which result is 0.323 (product innovation); 0.238 (process innovation); 0.264 (market innovation); 0.287 (supply source innovation) each toward performance organization.



Standard errors for path coefficients					
	iProduk	iProses	iPasar	iBahan	Kinerja
iProduk					
iProses					
iPasar					
iBahan					
Kinerja	0.323	0.238	0.264	0.287	

Figure 1. Standard Errors

Effect size can be categorized into three categories; weak (< 0.02), moderate (0.15), and strong (> 0.35). The results of the estimation of the effect size shows that product innovation (iProduk) has an effect size influence on the performance of medium (0.163), in the innovation process (iProses) has an effect size influence on performance are (0.097), on innovation markets (iPasar) has an effect size effect on performance is very weak (0.010), and on the innovations of raw materials (iBahan) has an effect size influence on performance are (0.166).

Effect sizes for path coefficients					
	iProduk	iProses	iPasar	iBahan	Kinerja
iProduk					
iProses					
iPasar					
iBahan					
Kinerja	0.163	0.097	0.010	0.166	

Figure 2. Effect Sizes for Path Coefficients

Product innovation effects organizational performance in the culinary industry in Braga district, Bandung of 16.3%. Lack of product innovation can lead to the low performance of the Organization, but at a certain point product innovation conducted when excessive making organizational performance to decline.

Innovation processes have 9.7% effect to organizational performance in the culinary industry in Braga district, Bandung. Innovation process such as process improvement work, the use of the machine (to increase the speed, efficiency and effectiveness of work), using



technology to improve work process get faster and easier, or the use of technology to facilitate organizations achieve customer satisfaction, in addition, can also facilitate employees in improving service quality to satisfy consumers and will be followed by the improvement of organizational performance.

Market innovation has an impact on the performance of the Organization in the culinary industry at Braga district, Bandung, by 1%. Organizations that increase tendency has increased its market share on the performance of the organization. However, it was found that the culinary industry in Braga district, Bandung, apparently tend to be static, never open a new branch, the new restaurant and a variety of new methods of innovation markets. That's why market innovation has The smallest effect to the performance organization.

Supply source innovation has an impact on the performance of the Organization in the culinary industry in Braga district, Bandung, by 16.6%. It can be concluded that the General (the starting point) the organization does not want to do the speculation with the use of raw materials is not qualified because basically the Organization has been using high quality raw materials. However, with the innovation of raw materials, such as the use of liquid nitrogen to make ice cream, or on the culinary industry bread which adds to a list of bread them with healthier whole grain breads and high fiber, and low in calories, are able to improve the product variant owned and characterizes itself, which can improve the consumer's interest to come or try. However, at some point, the raw material of innovation too much can also effect the performance of the organization. It is based on the culinary industry, raw material stands to have vulnerable a limited lifetime. In the culinary industry, if too much stock of unused raw material will cause the stock to be corrupted and instead will be a financial burden, so as to decrease the performance of the organization.

Composite reliability is use to know the reliability of the variables used, while cronbach's alpha is use to know the validity of the variable. The result of composite reliability of each variables are, 0.807; 0.911; 0.888; 1. And the result for cronbach's alpha are; 0.635; 0.883; 0.809; 1. From the data that shown, this research has a valid and reliable variable.

Figures 3 showed product innovation, process innovation, market innovation and supply Sources Innovation simultaneously effect the performance of the Organization in the



culinary industry in Braga district, Bandung as 44%. These findings indicate that there are other variables that effect the performance of the Organization of the culinary industry in Braga district Bandung.

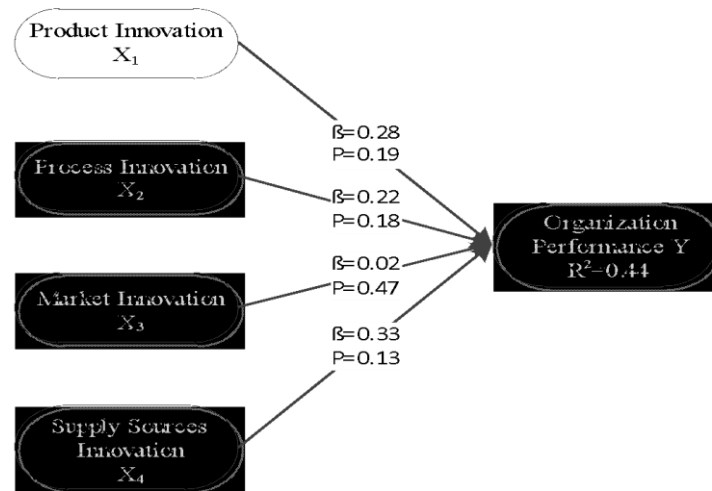

Figure 3. Research Model

CONCLUSION

Based on the data analysis found that 3 hypothesis reject and 1 hypothesis accept. But as a simultaneously innovation can determine organization performance as 44%. This fact show that innovation is the important variable to increase organization performance while another variable should find to strong Braga culinary district. Hence to understand the condition this fact is very interesting to research more. Moreover, this result shows the specific situation of culinary industries Braga. Product innovation and supply source innovation give the bigger effect to organization performance while process innovation and market innovation give smaller effect than another antecedent. This result shows that some strategy and policy should developed for Braga District. Strategy to increase innovation and collaboration with regulator also need to improve this industry. Our focus to increasing innovation can begin from the product and supply source as continuously improvement. Process innovation could be done with adopt new technology and service. Then market innovation can be done with expand market to some segment.

REFERENCES

- Abouzeedan, A. (2011). *SME performance and Its Relationship to Innovation*. Sweden: Linkoping University.
- Hurley, R., & Hult, G. (1998). Innovation, Market Orientation and Organizational Learning: An Integration And empirical Examination. *Journal of Marketing*, 42-54.
- Kompas.com. (2014, 9 29). *bisniskeuangan.kompas.com*. Retrieved 1 24, 2015, from <http://bisniskeuangan.kompas.com/read/2014/09/29/211600926/Posisi.Industri.Kuliner.Cukup.Strategis.bagi.Perekonomian.RI>
- Kusumawati, R. (2010). Pengaruh Karakteristik Pimpinan dan Inovasi Produk Baru Terhadap Kinerja Perusahaan untuk Mencapai Keunggulan Berkelanjutan. *Jurnal Ekonomi dan Bisnis*.
- Metrotvnews.com. (2015, January 8). <http://ekonomi.metrotvnews.com>. Retrieved January 25, 2015, from <http://metrotvnews.com>: <http://ekonomi.metrotvnews.com/read/2015/01/08/342315/ridwan-kamil-bandung-favorit-keempat-wisata-asia>
- Prasetyo, B. (2014, Mei 21). *tribunnews.com/regional*. Retrieved January 24, 2015, from www.tribunnews.com: <http://www.tribunnews.com/regional/2014/05/21/setiap-tahun-6-juta-wisatawan-mancanegara-datang-ke-bandung>
- Pusat Data dan Analisa Pembangunan Jawa Barat. (2014, February 25). pusdalibang.jabarprov.go.id. Retrieved from Pusat Data dan Analisa Pembangunan Jawa Barat Website: pusdalibang.jabarprov.go.id/pusdalibang/beritastatistik-r48.html
- Schumpeter, J. (1934). *The theory of economic development*. Cambridge, Massachusetts: Harvard University Press.
- Sholihin, M., & Ratmono, D. (2013). *Analisis SEM-PLS dengan WarpPLS 3.0 - Untuk Hubungan Nonlinier dalam Penelitian Sosial dan Bisnis*. Yogyakarta: Penerbit Andi.
- Sriwati, D. (2012). *Pengaruh Pemberian Dana Bergulir terhadap Kinerja UKM, PT. Perkebunan Negara III (PERSERO) Kota Medan*. Medan: Universitas Terbuka.



- Supranoto, M. (2009). *Strategi Menciptakan Keunggulan Bersaing Produk melalui Orientasi Pasar, Inovasi, dan Orientasi Kewirausahaan dalam Rangka Meningkatkan Kinerja Pemasaran*. Semarang: Universitas Diponegoro.
- Vries, H. d., Bekkers, V., & Tummers, L. (2014). *Innovation in the Public Sector: A Systematic Review and Future Research Agenda*. Rotterdam: European Union Seventh Framework Programme.
- Wheelen, T. L., & Hunger, J. D. (2012). *Strategic Management and Business Policy 13th Edition*. New Jersey: Pearson Education, Inc.



**STRATEGIC ADVANTAGES OF PT WILLMAR CAHAYA INDONESIA, TBK:
CASE STUDY USING SWOT ANALYSIS**

Fajar Rezeki Ananda Lubis

Ida Bagus Alit Ksama Putera

Master of Management Science Program, Universitas Padjadjaran

fajarrezekiananda@gmail.com

agusalit73@yahoo.co.id

Popy Rufaidah

Faculty of Economics and Business, Universitas Padjadjaran

popy.rufaidah@fe.unpad.ac.id

Abstract

The purpose of this paper is to discuss the strategic advantages of the company, which specialized in the industry of vegetable oils. The paper provides the analysis result of strategic advantages of PT Willmar Cahaya Indonesia, Tbk that is primarily engaged in manufacturing oils for food confectionery industries. The products of this company are made of palm oil, palm kernel oil and illipe nuts. The produced oil includes of cocoa butter equivalent(CBE), cocoa butter replacer(CBR) and cocoa butter substitute(CBS).

The research uses a case study method with SWOT Analysis based on the analysis of functional business. The aim of this research is to present information in structured, factual, and accurate way in the object studied. The method used is through SWOT Analysis to examine the strategic advantages of the company.

The findings of this study is to present the strategic advantages of the company based on the financial and non-financial performance, such as performance in the area of marketing, human resource management and operations of the company. The paper also produces the summary of the strategic factors consisting of the internal and external factors, which are summarized in the table IFAS, EFAS and SFAS as a basis for designing programs that can be done by the company.



This study provides the managerial impact to the company studied, namely the establishment of the appropriate corporate strategic decision by the strategic advantages of the company based on the financial and non-financial aspects. For example, based on the companies analyzed: the overall financial performance shows the good performance despite the increasing liabilities. Furthermore, the performance of marketing requires a decision of more aggressive marketing strategy to market their products to the foreign market.

This paper discusses the strategic advantages of PT Wilmar Cahaya Indonesia, Tbk based on the excellence of the functions of finance, marketing, human resource management and operations of the company.

Keywords: *Strategic Advantage and Vegetable Oils Industry.*

JEL Classification: *L29*

PREFACE

Globalization and Liberalization bring the big change of impact and the rapid economic change in the world. The impact influences some sectors, one of them is the industry. In this regard, the industry should be able to increase the high competitiveness in the economy. The high competitiveness should gained by the economic sector to support the Indonesian industries exist in the economic field.

One of the industries that is concerned is vegetable oil industry. Vegetable oil industry is a strategic industry because this industry takes a role as a supplier for the basic ingredients to other industries especially the food production in our country or other countries. The vegetable industry as a strategic industry which supports the other industries to produce the important raw materials in overall or especially the food industries.

Vegetable oil demands in Indonesia keep increasing, supported by the consumer demands. The high demand by the private industries and the increasing needs of quality products for people. Increasing the output of production can meet the vegetable oil needs in the large number. The large Indonesian market builds very competitive competition in the industry sectors such as motivating the foreign investors to involve in the domestic market to support the vegetable oil factories. The foreign investors join with the local vegetable oil



industries to be the competitors for other holdings company, such as Tradesound, Public and Rising Shine.

The competitors can increase the vegetable oil production capacity with support of the raw materials supply from their investors. Furthermore, competition can increase through the entry of the products. The presence of foreign investors, imported products and inexpensive vegetable oil products can be seen in PT. Wilmar Cahaya Indonesia positions as the large vegetable oil producer in Indonesia.

Wilmar Chaya Indonesia (as known as Cahaya Kalbar Tbk or code in stock exchange Indonesia as CEKA) established in February 3rd 1968, known as CV Cahaya Kalbar starting to operate as commercial entity in 1971. CEKA office was located in Jababeka II Industry Area at Jl. Industri Selatan 3 Blok GG No.1, Cikarang, Bekasi 17550, West Java, whereas the factory was located in Kawasan Industri Jababeka, Cikarang, West Java and Pontianak, West Borneo (www.wilmarcahayaindonesia.com). The holding company who has the largest stock in Wilmar Cahaya Indonesia Tbk, is Tradesound Investments Limited (87,02%). The main company of CEKA as a primary company is Wilmar International Limited, the company that saves their holdings in Stock Exchange of Singapore (annual report wilmar cahaya Indonesia 2015).

In Accordance with the Articles of Association company statute, the company is engaged in food industry sectors such as vegetable oil industries consisting of the crude palm oil and its derivatives, illipe nuts, illipe oils, and vegetable oil; activities in general trading of domestic, export-import, and trading of agricultural products, forest products, trading daily need goods. In the present, the main products which are produced by CEKA:Crude Palm Oil (CPO) and Palm Kernel etc. (annual report wilmar cahaya Indonesia 2015). The company expertise in producing palm oil and illipe bean convert to special quality of vegetable oil also Cocoa Butter Equality (CBE), Cocoa Butter Substitute (CBS), Cocoa Butter Extender (CBX), and Cocoa Butter Improver (CBI) (www.wilmarcahayaindonesia.com).

Business future condition is highly uncertain and unpredictable. This reality is required for company to fix strategy as continuity based on the company experiences by now. Because of this matter, the company should fix their strategy in order to always capable with



the external and internal changes in the company. Furthermore, the company is required to prepare itself to compete in the future with the dynamic competition.

From the above description of the problem formulation of the study, there should be a study to analyze the strategic advantages of PT. Wilmar Cahaya Indonesia Tbk, which would be the benefit for the industry analyzed. This paper is organized as follows: Section 1 contains the profile of the company based on the financial performance. Section 2 presents the reason for using case study method and the research design, the criteria used to interpret the findings of the results. Section 3 discusses the findings of the study. The paper concludes the results of the study in Section 4.

LITERATURE REVIEW

Strategic Advantages

Competitive advantage is a predominance strategy that benefit the company which have an effective competency in the market place. Strategy should be designed to maintain the benefit level and to create the superiority in the sustainable competition. Therefore, the company is able to dominate the old market and new market (Porter, 1993).

Competitive advantage is superiority competitor which is can reach strategy success in applying with identified assets (resources) in the real company. With *Tangible* and *Intangible resource* which make that organizations to more uniquely. With knowing this company aspects can optimize resources use to create predominance competitive. Also fixing and removing the unqualified resources. (Afuah, 2003).

Hamel and Prahalad (1994) also used term of main competency for advanced capability as base predominance in the products and services. The main competency is set of skills and technology to enable a company serve some advantages for customers. The company which has the willing for the big benefit should create competencies that have to give the important contributions to the customers later. The competition to take the competencies not about the competition of products or between business, but competition between the companies. The main competencies of distribution for the competitive ability in the products and services, win or lose to reach superiority in competition can make the big



impact for potential growth and differential competition of the companies. In other words, competitions in the present and future should be dynamic not static.

Rufaidah (2014) agreed with Barney's opinion (1991) who recommended 3-4 competencies for a company when implement the strategic move: *Valuable* is a supporting ability to neutralize the threats or using the opportunities; *Rare* is capability which not possessed by other competitors; *Costly to imitate* is capability of other competitors which cannot evolve easily; usually caused by the unique historical conditions, social complexity; *Nonsubstitutable* is the strategic ability which is not same with the other competitors; such as the specific knowledge about the company, cooperation trust between the managerial and non-managerial employees.

Strategy is a skill urgently needed by the professional in business world. Strategic advantages are the superiorities which have fundamental effect to support the company operations. Information system can be useful to reach the strategic advantages. Our dimensions that are recommended by the potential strategy is not the same as the Porter's opinion, that suggests the financial costs and uniqueness claimed by the customers is important for the market competition. As illustrated in literature, the incumbent can reach the strategic benefit through increasing the switching consumer costs, access to crisis stocks and for distribution channel. This study uses the concept of strategic advantage from Porter (1980) who explained that strategic advantage dimension of the competitive advantage.

RESEARCH METHOD

The research method used is a case study. Most of the case study researches usually refer to Yin Case studies that generally refer to detailed investigations of several variables in regard to isolated occurrences or objects (Berg 1968:1). Eid et al (2006:94-95) applies the case study method in their study, and focused on the description and analysis of the qualitative data to explore the case of the company. They present the details of the case study findings and reports the variables analyzed from the perspective of the company. However, this paper discusses the details of the case study findings and reports the variables analyzed from the perspective of the writer. Based on the concept, the steps being taken are, (1) Data collection and analysis on the strategic advantages of the company. (2) Determination of the



type and design of the study. The data used in this research is secondary data from 2014 to 2015. This data is in the form of annual report of PT. Wilmar Cahaya Indonesia Tbk. The data is used to analyze the pressures from micro-environmental toward PT. Wilmar Cahaya Indonesia Tbk. (3) Data Analysis Methods. to determine the strength and competitiveness of the industry in vegetable oil industry at PT Wilmar Cahaya Indonesia Tbk, the indicators of the industry competitiveness are used by identifying number of strategic strengths of the company based on the business functions, such as marketing, finance, operations and human resource management. This study analyzes the strategic advantages of the company.

RESULTS AND DISCUSSION

External Environment Analysis

PT.Wilmar Cahaya Indonesia has the opportunities and threats from the external environment that are political aspects and regulation, economical environment, social-cultural environment, and ecology. In the political aspects and regulation consisting of constitutions, government regulations, and local regulations provide the good impact for the company, such as UU Number 39 (2014) paragraph: 22,point: 1-2: the central government facilitate to enrich the genetic resources (plant and farm) giving the easiness on permission and using the research facilities of the state properties and local properties and the enrichment of the genetic plantation resources. Paragraph 39 point 1-3 and paragraph 95 point 1-2: on giving the permission of the investment from the foreign countries and the local, Paragraph 44 point 2 : Cultivation business can make diversification such as agrotourism, Paragraph 51 point 1-3: farming the business empowerment, Paragraph 72 point 3 and Paragraph 73 point 1-3: output manage development, Paragraph 87 point 1: central government has to conceal information about the businessman. There are not only more regulation which supports the existence of the palm oil industries , but also there are regulations which can be implemented for the company, such as President regulations No 61(2015): on collecting and using palm funds, the regulation results more costs for this industry. Trades Minister Regulation No 65/M-DAG/PER/9/2016 Paragraph 1 and 2on the cost confirmation, in this regulation the cost determined by universal CPO. The threats also occur due to political situation in Indonesia



because there is a conflict between political parties and government power, this problem impacts to the economic conditions in Indonesia especially in low money value changes or inflation, in other words resulting the effects to this industry.

The analysis of economical aspects is the bank interest, the factory has threats between 2014 until 2015 that is the sinking of the bank interest. The high unemployment and impact to increase the needs for jobseeker, such case resulting the industry becomes easier to search the fresh graduate employee with lower salaries, because the bargain of job applicant is too low, the revaluation of threat happened is because weakening process to importer countries such as sinking price of soya oil and sunflower seed as the substitute products from CPO, then the importer countries move to substitute the productions and also the threats of the energy existence in 2013, when the palm oil production was in the high level, this case result the negative impact, because the demand was sinking.

PT Wilmar Cahaya Indonesia in the environmental-cultural aspects has a chance in lifestyle changes process, when lifestyle changes make consumptive culture, but results the positive impact to the industry because level of demand is increasing, this opportunities is about increasing population and having good effects, as well as gaining the productions result. The threats which faced by life expectancy aspect can be negative impact for lifestyle changes because the untrue issue about the vegetable oil.

PT Wilmar Cahaya Indonesia in technological aspect has the good opportunities to develop the new products because can support the company to develop the vegetable oil product which has mutual functions for the other products to be an innovation.

PT Wilmar Cahaya Indonesia in ecology aspect has threats when el nino happening in 2015 until 2016 which influences the palm production. Natural resource change is one of threats that can be the negative impact for costs and price of soya oil and sunflower seed (USA and Europe), decreases the demand level of vegetable oil, threat is also occurred by the disaster. If Force Majeure is really happened, that can be classified to the extraordinary phenomena (not caused by other subjects), which interfere the company activities, as overall or partial, responsibility or obligation, and the last threats to natural damage. In 2015, great forest fires in history occurred and were caused by oil palm companies, one of them was Wilmar and there was the negative issue concerning palm oil because this resulted pollutions



and as opponent of environmental activists. The results of external factor analyzed, explained in this table:

Table 1. External Factor Analysis Summary

External Strategic Factor	quality	Rating	Score	Explanation
A. Opportunities				
Lifestyle Changes (Social Cultural Environment)	0.20	4.00	0.80	Lifestyle Changes in consumptive level including food has good impact to industry because vegetable needs is increasing.
Population Increase (Social Cultural Environment)	0.17	4.00	0.68	Over population has good impact, because this increases the quantity of products.
Product Development (Technology)	0.18	3.00	0.54	Vegetable oil production can open the opportunities for the company to develop because has the good function especially in raw material for another industries
Innovation in Technology (Technology)	0.12	3.00	0.36	Along with the product development, requires a new development to innovate the products.
B. Threats				
Devaluation (Economy)	0.07	1.00	0.07	Economic slowdown of the importing countries such as the decline of soybean oil price. Further, the low condition of economic world that is



				resulted by the importing countries undertake economic policies that have an impact on demand for CPO.
The Existence of Economy (Economy)	0.06	2.00	0.12	In 2015, over supply occurred
Condition of Environmental Damage	0.09	3.00	0.27	In 2015, great forest fires in the history occurred and was caused by oil palm company. One of the companies is Wilmar and there was the negative issue concerning palm oil because resulting the pollutions and as the opponent of the environmental activists.
Natural Disaster Potential	0.11	4.00	0.44	Force majeure is really happened, that can be classified to an extraordinary phenomena (not caused by other subjects), which interfere the company activities, as overall or partial, responsibility or obligation, and the last threats to natural damage.
Total	1.00		3.28	

Strategic Benefit of Financial Performance

Valuation of financial performance is based on the increasing salary. This is reflected by one report, the report which describes about the financial performance of company development at several periods, financial performance can describe about financial situation of the company based on the target, standard, and criteria as explained by Sawir (2005:1). This report is usually called by financial report. The purpose is to gain the financial report



that is make a sense for company, especially PT. Wilmar, to be able in evaluating the performance of the company at previous period. The financial performance analysis can realize with some way from general method such as the financial company ratio.

Table 2. Financial Performance Analysis of PT Wilmar Cahaya Indonesia Tbk

Ratio/year	2015	2014
LIQUIDITY RATIO		
Current ratio	153.46%	147.56%
Quick ratio	49.46%	80.33%
Cash ratio	1.32%	3.85%
Cash turnover	322.15	133.58
Inventory to net working capital	97.26%	142.23%
LEVERAGE RATIO		
Debt to asset ratio	56.93%	58.13%
Debt to equity ratio	132%	138.88%
Long-term debt to equity ratio	4.6%	5.19%
Times interest earned	4.79	2.38
ACTIVITY RATIO		
Inventory turnover	8.21	7.78
Working capital turnover	7.98	11.06
Fixed assets turnover	14.97	16.04
Total asset turnover	2.35	2.88
PROFITABILITY RATIO		
Gross profit margin	8.5%	6%
Return on investment	7.1%	3.1%
Return on equity	16.6%	7.6%
Earning per share	179.07	68.91



Net profit margin	3%	1.1%
MARKET RATIO		
Market to book ratio	1	1
Price/earning ratio	1.39	3.62
GROWTH RATIO		
Sales	-0.06 %	0.46 %
Net income	1.59 %	-0.36 %
Earning per share	179.07	68.91

Table 3. Value of Sales and Net Income (In Billion Rupiah)

Variable	2015	2014	2013	2012	2011
Sales	3,485	3,701	2,531	1,123	1,238
Net Income	106	41	65	58	96

Based on the financial performance analysis results, PT Wilmar Cahaya Indonesia Tbk, indicated that the performance is good if this is seen as overall because there is clean benefit from the normal condition. In ratio liquidity that indicating there is increasing current ratio at 6,9 from 2014-2015 that means the company can manage short term asset, creditors can trust the company because the company can pay short term debt. But in quick ratio there is a big sinkage: 30,87% it is showing the negative condition, because every one debt of rupiah is handled by 0,49 fluent asset except for the company stocks which need salary to hide the short term debt. In cash ratio there is sinkage, around 2,53% that indicates about company condition that is unable to be maximized fluent fund and using assets and marketable securities which are company properties. Based on this condition, company capability is paying with assets, sales, and available stocks. In 2014-2015 there is increase of 188,57 on cash turn over short term implication company can optimize their activity. Inventory to sinkage of net working capital is around 44,97% in 2014-2015 if the implication less than 100% therefore the liquidity has high level.

In leverage ratio, the debt to asset ratio is in significant sinkage that around 1,2% in that case the company is in good condition because the proposition asset of the company paid



by short term debt. Company does not get surplus load of asset in the company. In debt to equity, the company is in negative condition because more than 50% although there is sinkage from 2014 but not too significant, this case impact to short term of operational fund by equity is less. Long-term debt to equity ratio that is under 50 % and sink to 2014, indicates that the company is in good condition. Times interest earned in this company which increases the conditions indicates that the company can handle the charge which has to pay with benefit.

In ratio activity, inventory turnover of the company is increasing but not too significant that indicates the use of facility to produce the salary is climbing. Working capital turnover is sinking when the company ability that sell from capital working is less. In fixed asset turnover indicates that from 2014 where this is caused by the decreasing of fix asset and selling by the company. The company does not maximize in the use of fix asset to produce salary. Total asset turnover in this company is sinking whereas this company ca not be efficient to use the assets.

In profitability ratio, there is increasing gross profit margin, this increase can be a good value for the company because the investment supported by the company to produce the effective benefit. Return on investment is increasing whereas effect to the investment implemented by the company was effective and efficient. Earning per share is increasing from 2014 whereas this indicates the company is able to give the advantage as the expectation of the holding companies. Net profit margin is increasing and this indicates that the performance in overall is good.

Strategic Benefit Based on Functional Business

In this part, this will indicate concerning the analysis result and superiority strategy in this company based on marketing function, finance, operation and human resources management. Strategic power in this company is in marketing field because the product which produced by PT Wilmar Cahaya Indonesia has followed the standard which determined by the government. The company has gained the certificate of Halal guarantee by PT TUV NORD Indonesia and accepted by international standards through obtaining System & Service, therefore in marketing is highly strong with the results score that is 0.35. The



weaknesses in strategic marketing is less because PT Wilmar Cahaya Indonesia does not have the product that can be marketed directly to consumers and the company always follows the world price so it keeps the price fluctuations with the results score that is 0.20. In the field of marketing, the lifestyle changes that is consumptive, also a positive impact on the industry because the request of vegetable oil always increases in which seen from marketing whereas score results around 0.3. In addition to the threat of economic marketing of importing countries, such as soybean oil prices decline. Further the low condition in economic world, resulting in, importing countries undertake economic policies that have an impact on demand for CPO with score which is 0.3 threat results has been faced by PT Wilmar Cahaya Indonesia. In the processing of its products and product designed by PT Wilmar Cahaya of Indonesia has met the standards that have determined by certified halal by the MUI, has been certified OHSAS 18001: 2007 and has been recognized by international standards by obtaining System & Service Certification Food Safety System 22000: 2015. The company focuses producing vegetable oil products, namely CPO and Palm Kernel but this company does not make a lot of innovation for the company products, because the company focuses on the production of raw or semi-finished goods. The company has two strategic manufacturing site, the plant Pontianak which is near of the plantations, to obtain raw materials and factory Cikarang industrial location is near of the capital makes it easy to distribute the products.

In this company human resources is quite superior, can be seen online recruitment process to encompass all walks of life, provide training and education to employees of PT Wilmar Cahaya Indonesia and assess performance. With training and career development for the employees of PT Wilmar Cahaya Indonesia, the company should to develop the employees ability and can be contributed to the maximum line with the company's long-term needs. PT Wilmar Cahaya premises are very concerned resource can be seen from the well-being of an employee which facilitates employee to provide the necessities of life especially in the plantation area of the amenities of home and appliance transportation , implementing K3 program to improve safety and minimize accidents and compensation granted to employees, the company also provides employee pension fund.

In function of the financial management of companies that receives funds from shareholders and third parties, namely the banks, compared with the year 2014 the company



increases total liabilities amounted to 13, 30% from 2014 and this is a negative impact for the company because this has to reserve more funds to pay off its liabilities, among others with the increasing of sales and accelerate billings to billing of customers. While the allocation of funds used to supplement the company current assets, namely lending to related parties, PT Wilmar Nabati Indonesia with prepaid taxes, non-current asset purchases to boost production capacity, and purchase The purchase of raw materials. This raw material purchases benefit the company because of the weak market prices therefore the impact on the decrease in raw material prices, thereby increasing profit bruto, payment of corporate income tax expense increased due to increased corporate profits. Company in 2014 and 2015 have not been able to issue a dividend because this needs fresh funds because of the effects of the weakening global economy. The results of the analysis of the company internal environment outlined in Table Internal Factor Analysis Summary.

Table 4. Internal Factor Analysis Summary

Internal Strategic Factor	Weight	Rating	Score	Description
A. KEKUATAN				
International standardization Product	0.13	5.00	0.65	the resulted product follows the standards of the government; Halal certified and based on the international standards by obtaining System & Service.
Financial (<i>Allocating fund</i>)	0.09	4.00	0.36	Allocation of the funds used to purchase the company assets, such as lending to related parties (PT Wilmar Nabati Indonesia), and the purchase of non-current assets to increase production capability.
Human Resources (<i>Maintenance</i>)	0.08	3.00	0.24	PT Wilmar Cahaya Indonesia maintains human resources in terms of welfare, safety, health and environment, compensation, and career



				planning.
Human Resources (Development)	0.13	2.00	0.26	Provide training and education on PT Wilmar Cahaya Indonesia employees, and assess performance. .
Plant design and services	0.15	3.00	0.45	Has two factories with a strategic position in order to make it easier to distribute the product
B. Weakness				
Financial (dividend policy)	0.09	1.00	0.09	The Company cannot pay any dividends to its shareholders.
Financial (Obtaining fund)	0.07	2.00	0.14	Increase the total of liabilities of 2014 amounted to 13.30%
Operation	0.07	3.00	0.21	Products which produce the raw materials and semi-finished materials
Selling Strategy	0.05	1.00	0.05	has no product that can be marketed to consumer.
Pricing Strategy	0.14	2.00	0.28	Prices followed the world price, so keep price fluctuations
Total	1		2.73	

CONCLUSION

PT Wilmar Cahaya Indonesia in marketing the products standards international premises at competitive prices depending on the type and total, in term of price, Wilmar also has two factories in which to launch the process of production, in promotion, Wilmar do business to business (B to B), to support passage of the company, Wilmar obtained from Tradesound investment Ltd, public and Sine Rising Investment. On the side of other company also view to support the activities of PT Wilmar Cahaya Indonesia in managing quality human resources, then Wilmar conducts training and education for the employees and does not forget to pay attention to their health. To expedite operations rely Wilmar 2 factories with the aim to make it easier to distribute its products. The strength of PT Wilmar Cahaya



Indonesia is on the quality of products that are of international standard, the allocation of appropriate funds so that it can manage finances well despite the conditions experienced moderate decline in sales, maintenance and development of good human resources so as to avoid the onset of problems due to human error or labor conflicts. The weakness is not issuing dividends to shareholders, increase liabilities when that is not appropriate, the resulted product in the form of raw materials or semi-finished so that market share cannot be reaching the final consumer, and fluctuating prices caused by the global economy. Opportunities that the company possesses are of lifestyle changes along the passage of a consumer society followed with the increasing population growth so the demand for vegetable oils also increased, vegetable oil products was very open for companies to be able to innovate and develop products. Threats faced by PT Wilmar Cahaya Indonesia is economically economic slowdown in the importing country, in terms of the environment have the issue of black campaign palm oil is not environmentally friendly accompanied by the occurrence of large forest fires in Indonesia and the potential for natural disasters (force majeure) which high.

Capability of PT Wilmar Cahaya Indonesia in terms of tangible, wilmar even par with competitors because the resources have criteria of value, but not unique among others in: cash accounts, accounts receivable, facilities, location, innovation, patent, trademark, the effectiveness of their strategic planning, superior control and evaluation system. Wilmar HR of tangible source said even par with competitors, of innovation has aligned with competitors and Wilmar Wilmar report as parallel here with competitors. The organization's ability to service customers, hiring and retaining human capital is still in parallel position to its competitors. But the emergence of competitors to be one serious threat for the Company. PT. Astra Agro Lestari Tbk. Incorporated in the Indonesian stock exchange is one of the contenders for Wilmar, PT. Astra Agro Lestari Tbk. HRM has strength where the most important and fundamental aspects for the Company is the management of Human Resources (HR) or Human Capital Management as key determinant of progress and the future success of the company in order to obtain high quality human resources. According to the basic principles of the Company, HR is a major asset. In the midst of increasingly severe business challenges and competitive, the Company ensures that existing human resources should have the advantage on all fronts, from the leadership of the Company until the worker in the field.



HR of the Company shall have good competence and improved so that each is able to give the best contribution to the progress of this Perseroan. Currently, the Company has permanent employees as much as 36 214 people. Palm oil sector is labor-intensive sectors that absorb labor in very large quantities. Therefore, the Company should establish a human resources management system that is robust and able to guarantee every individual to contribute their best to the company.

RECOMMENDATION

The analysis result of the strategic advantages of the company indicates the number of recommendations, including a company can implement some decisions to: (1) allocate resources to fund both to seize opportunities various market segments can be served company therefore to improve access to foreign markets; (2) Prevent or reduce additional borrowing of funds to a third party, on the medium term; (3) maintain market share and targets new markets through strategic long credit sales over the competition and of the long-term; (4) conduct a more attractive product innovations for the targeted market segments served; and (5) Become a corporation that process raw materials, finished products that are ready to be marketed to the final consumer. (6) Innovate products more attractive to target market segments; and the company processing raw materials into products ready to be marketed to the final consumer.

REFERENCES

- , 2015. *Annual Report PT Wilmar Cahaya Indonesia Tbk*. IDX. Jakarta
- Afuah, Allan (2003). *Business Models A Strategic Management Approach*. Mc Grawhill. New York.
- Berg, C (1968). Case Studies in Organizational Research and Education. *Acta Sociologica*,11(1/2), 1-11.
- Eid, R., Elbeltagi, I., & Zairi, M. (2006). Making Business-to-Business International Internet Marketing Effective: A Study of Critical Factors Using a Case-Study Approach. *Journal of International Marketing*,14(4), 87-109.



Hamel, G & Prahalad, CK (1994). *Competing for the Future*, USA: *Harvard Business School Press*.S

Porter, Michael E,(1993). *Keunggulan Bersaing : Menciptakan dan Mempertahankan Kinerja Unggul*, Cetakan Kedua, Erlangga, Jakarta.

Porter, Michael E,(1990). *Competitive : Techniques for analyzing Industries and Competitor*, The Free Press, Mc Millan Inc, New York.

Rufaidah, Popy. (2014). *Manajemen Strategik*. Edisi Pertama, Cetakan Ketiga, Penerbit Humaniora.

www.wilmarcahayaindonesia.com accessed on 12-3-2017



**IMPROVEMENT ON DELIVERY SERVICE IN DROPSHIPPER COMPANY: CASE
OF AQUARIST FARM**

Brian Lee

Mursyid Hasan Basri

Bandung Institute of Technology

brian.lee@sbm-itb.ac.id

mursyid@sbm-itb.ac.id

Abstract

Despite the rapid increase of E-commerce users, there are some issues available, such as customer's behaviour, payment infrastructure, logistic infrastructure, legal and regulation infrastructure. However, in this journal, only logistic infrastructure is discussed. Currently, Aquarist Farm, a drop shipper company based on livestock, also has problems on logistic which lead to poor delivery service.

To find the root causes, conceptual framework is developed based on the 5 delivery service qualities (tangibility, empathy, reliability, responsiveness, assurance). After being surveyed, the customer concerns are on the Empathy and Tangibility of the delivery service. There are 6 root causes to be discussed in this research: document error, Aquarist Farm policy, few numbers of suppliers, supplier's attitude, lack of response of Aquarist Farm, lack of website information.

After calculating the result from criteria and impact, The best solution for each root causes is giving compensation to the customer for document error, consolidating number of routes for Aquarist Farm policy, making own farm for few number of suppliers, changing supplier for supplier's attitude, setting a reminder to reply for lacking of response to customer, adding more website for lacking of website information..

Keywords: Drop shipper, E-commerce, service quality, delivery service

JEL Classification: L87



INTRODUCTION

E-commerce is the abbreviation of electronic commerce and can be defined as the conduct of selling, buying, doing logistics processes, or other management issues via the web or internet ⁽¹⁾. E-commerce allows consumers to electronically exchange goods and service with no barriers of time and distances. Electronic Commerce has expanded rapidly and continued to grow and even accelerate due to rapid growth of technology.

Despite that rapid increase of E-commerce user in Indonesia, there are some issues available ⁽²⁾:

- Behavior. Indonesia is still lacking to trust in E-commerce sites. ⁽³⁾. Moreover, internet penetration in Indonesia is also still low (23% of total population) ⁽⁴⁾.
- Payment Infrastructure. Most of transactions are still using bank transfer method which requires more procedures. ⁽⁴⁾
- Logistic Infrastructure. Most E-commerce startups aren't paying attention to this issue, because they think that they only provide the market place without concerning the logistics. According to the survey by Dailysocial.id (Figure 1.1), delivery time and order status are the main issues of logistic infrastructure. ⁽⁵⁾
- Legal and Regulations. Currently, E-commerce players are not convinced by absence of laws protecting them.

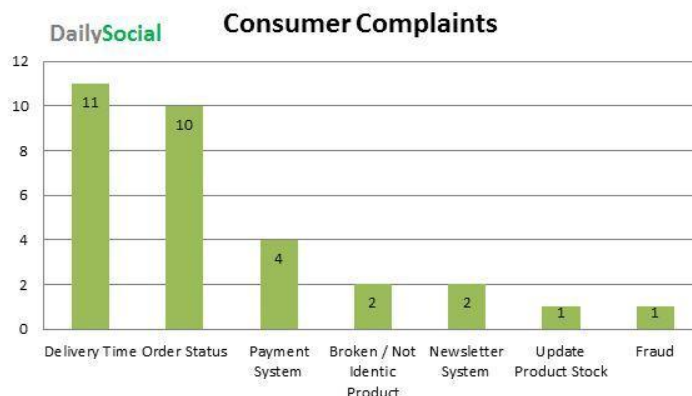

Figure 1. The survey of logistic infrastructure problem.

Source: Dailysocial.id, 2015

Despite those issues mentioned above, in this journal, only **logistic infrastructure** will be discussed. This is because the company that is a subject to this research is currently facing the logistic infrastructure problems. Thus, the main question is **how Aquarist Farm can solve these delivery issues while logistic service is outside of company's reach.**

Aquarist Farm is an E-commerce company based on livestock. The products are freshwater prawns. However, this E-commerce company is using drop shipper system which means that the owner of the company doesn't own the product. Thus, the owner, Michael Adiputra, works only as marketing officer and delivery admin. As marketing officer, the supplier's products are being advertised by himself and as delivery admin, the delivery service is being monitored by him and the report status of the delivery is sent to the customer.

Aquarist Farm's business process is basically connecting the suppliers and the customers through this company. Customers will ask and negotiate the price with the marketing officer, then transfer the payment. After dealing, marketing officer will pay the price to the supplier and ask the supplier to transfer the goods to the customer with the confirmation from marketing officer. The price gap between payment from customer and price from supplier is Aquarist Farm's Revenue.

The survey held for its customer (Figure 1.3) also told that the complaint mostly put on delivery service. There are 19 complaints out of 33 about delivery service. Those are lack of the status of product and delivery (10 out of 33), delivery lateness (7 out of 33), lost of goods (1 out of 33), and product's death due to delivery (1 out of 33).

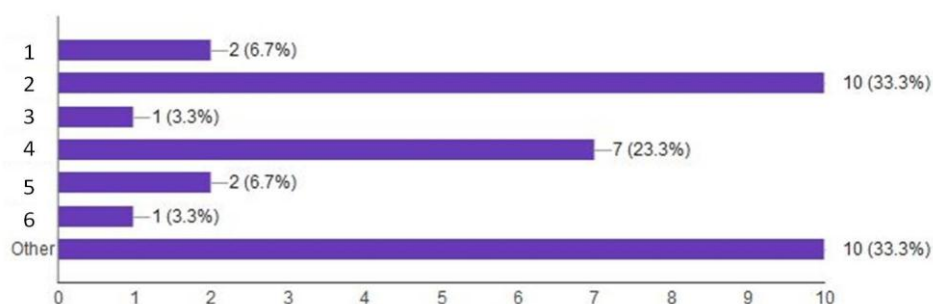

1. Dissatisfaction with the quality and the condition of the product
2. Lack of information about product or delivery service
3. Lost of goods or Didn't accept the product
4. Lateness of Delivery time
5. Slow Response from Aquarist Farm
6. Ignorance to customer's situation

Figure 2. Survey of Complaints



LITERATURE REVIEW

The literature reviewed for this research is 5 service qualities (Pasuraman, et al., 1990). Those are tangibility, empathy, reliability, responsiveness, and assurance. ⁽⁶⁾

Tangibility refers to the appearance of physical equipments, facilities, including work-on areas on-site. This also includes packaging quality and for E-commerce, website appearance.

Reliability refers to the company's ability of performing and completing the service accurately and correctly within the given set requirements between the company and customers. If it is about the delivery service, punctuality and quality of goods while being delivered is the factors that have to be considered.

Empathy refers to how the company gives individualized attention and care for their customers. This includes the liveliness of the communication occurred between each individual customer and the company. Moreover, in case of Aquarist Farm, Flexibility of delivery is also included because Aquarist Farm also negotiates the delivery schedule with the customer.

Responsiveness refers to how the company's willingness to help and provide the customers, with a good quality and fast service. Responsiveness is not also about how the company reacts when receiving order from customers but also about how company reacts when receiving complaints.

Assurance refers to how company can gain trust and confidence of the customers. The matching products quality as advertised from the website is one important factor for gaining assurance. The customer would also want the product to be guaranteed as an assurance for the goods being delivered.

Since the issue of Aquarist Farm is poor delivery service, the conceptual framework is built based on 5 service qualities.





Figure 3. Conceptual Framework

RESEARCH METHOD

The research method was using survey on Google Forms. 30 of its customers were asked to fill the survey via the link that has been provided. The survey was asking about the 5 service qualities mentioned above. There were 11 questions asked. Each 2 questions asked about each of the service qualities and 1 question asked about the overall quality.

The questions are:

- **Questions about Assurance (marked as “ASS”)**
 - (ASS1) How was the availability of information of the goods that will be delivered?
 - (ASS2) How was the quality of guarantee or compensation given by Aquarist Farm if there are unmatched goods, defects, or lost?
- **Question about Empathy (marked as “EMP”)**
 - (EMP1) How was the flexibility of the delivery schedule?
 - (EMP2) How was the liveliness of communication occurred (including about the unavailability of the goods and delivery delay)?
- **Question about Reliability (marked as “REL”)**
 - (REL1) How was the accuracy or punctuality of delivery time?
 - (REL2) How was the quality of goods while being delivered?

- **Question about Reliability (marked as “TAN”)**
 - (TAN1) How was the quality of packaging?
 - (TAN2) How was the clearance of Delivery information that is stated in the social media or website?
- **Question about Responsiveness (marked as “RES”)**
 - (RES1) How was the responsiveness of Aquarist Farm if you want to ask about products, and order products?
 - (RES2) How was the responsiveness of Aquarist Farm if you want to submit complaints?
- **Question about Overall Quality (marked as “OVR”)**
 - (OVR) How was the responsiveness of Aquarist Farm if you want to submit complaints?

RESULT AND DISCUSSION

Table 1. Survey Result

5 Service Qualities Parameter				
ASS1	ASS2	EMP1	EMP2	TAN1
4.1	4.2	2.83	4.27	4.13
TAN2	REL1	REL2	RES1	RES2
3.87	4.23	4.2	4.5	4.13
OVR				
4.0				

According to the survey result on Table 1 by the customer, there are 2 parts that gained the score less than 4.00. Those are EMP1 and TAN2. It can be determined the company lacks of Empathy and Tangibility. The question asked for EMP1 is “**How was the flexibility of the delivery schedule?**” and the question asked for TAN2 is “**How was the clearance of Delivery information that is stated in the social media or website?**” Low

score result on those two questions means that the company is not flexible at making delivery service and the company's website does not provide clear information about delivery service. Thus, It can be determined that Aquarist Farm lacks of Empathy and Tangibility at some points.

The 6 root causes can be found after doing root cause analysis:

- Document Error. Document Error is either wrong data input by supplier or correct data input but wrong product.
- Aquarist Farm Policy. The policy is made under the deal between the supplier and the drop shipper. There is limitation of 3 deliveries per supplier per day.
- Few Numbers of Suppliers. There are currently only 2 active suppliers from 3 suppliers available for Aquarist Farm only.
- Supplier's Attitude. One of the 3 suppliers available has bad attitude. This problem will need action to prevent the supplier's lateness.
- Misreport or lack of report to customer. This error can be categorized as simple human error.
- Lack of website information. Website needs regular update, especially to add more information such as, product and price, delivery service, and method of payment.

After determining the root causes, some alternatives of the solution have to be prepared, analyzed, and determined the best one for each root causes. Table 2 shows the alternatives for each root causes.

Table 2. List of Root causes and Alternatives Available

No	Root Cause	Alternatives
1	Document Error	Do nothing
		Prepare a list of document and check list
		Add more human resources for checking
		Give other type of compensation to the customer (discount voucher, or free delivery service)
2	Aquarist	Do nothing



	Farm Policy	Upgrade the policy slowly
		Consolidation number of routes
		Partnership
3	Few Number of Suppliers	Do nothing
		Add number of Supplier
		Partnership
		Make own farm
4	Supplier's Attitude	Do nothing
		Supplier change
		Make own farm.
5	Lack of Response to customer	Do nothing
		Set a reminder to reply if currently unavailable
		Set an Auto reply bot
6	Lack of Website Information	Do nothing
		Update the current website regularly and add more detail about delivery service
		Add more website for fulfilling lack of information on the main website.

The goal is choosing the best decision for each root causes. In order to choose the best decision, this research is using combined method between AHP (Analytic Hierarchy Process) and scoring method ⁽⁷⁾. The criteria for determining are QCDSM (Quality, Cost, Delivery, Safety, and Morale) ⁽⁸⁾.

The importance rate of each criteria to the alternatives are ranked with AHP method. The impact score of each criteria are ranked based on scoring method. Then, importance scores are multiplied with the impact to obtain the score of solution. Since there are 5 criteria, the score of each importance X impact are being summed to obtain the total score. The highest total score are the best solution alternatives for each root causes.

Table 3. Best Solution for Each root causes.

No	Root Cause	Alternatives	Score
1	Document Error	Do nothing	3.00
		Prepare a list of document and check list	3.83
		Add more human resources for checking	3.53
		Give other type of compensation to the customer (discount voucher, or free delivery service)	4.05
2	Aquarist Farm Policy	Do nothing	3.00
		Upgrade the policy slowly	3.06
		Consolidation number of routes	3.95
		Partnership	3.34
3	Few Number of Suppliers	Do nothing	3.00
		Add number of Supplier	3.57
		Partnership	3.21
		Make own farm	3.72
4	Supplier's Attitude	Do nothing	3.00
		Supplier change	3.74
		Make own farm.	3.34
5	Lack of Response to customer	Do nothing	3.00
		Set a reminder to reply if currently unavailable	3.59
		Set an Auto reply bot	3.50
6	Lack of Website Information	Do nothing	3.00
		Update the current website regularly and add more detail about delivery service	3.45
		Add more website for fulfilling lack of information on the main website.	3.70

CONCLUSION

This E-commerce company is lack of Tangibility and Empathy in their delivery service quality (logistic service). The poor delivery service is caused by 6 root causes:



Document Error. Aquarist Farm Policy, Few Numbers of Suppliers, Supplier's Attitude, Misreport or lack of report to customer, Lack of website information.

After doing some analysis using AHP, the best solution for each root cause can be determined. For document error, it is to give other type of compensation to the customer (discount voucher, or free delivery service). For Aquarist Farm policy, it is to consolidate some number of routes. For few number of suppliers, it is to make own farm. For supplier's attitude, it is to change the supplier. For lacking of response to customer, it is to set a reminder to reply if currently unavailable. For lacking of website information, it is to add more website for fulfilling lack of information on the main website.

REFERENCES

- <http://www.businessnewsdaily.com/4872-what-is-e-commerce.html> Accessed December 21st, 2016; 2:00 PM (GMT+7)
- <https://dailysocial.id/post/the-problem-with-indonesias-e-commerce-scene> Accessed December 21st, 2016; 2:45 PM (GMT+7)
- <http://www.marketing-interactive.com/events/indonesians-online-shopping/> Accessed December 21st, 2016; 3:00 PM (GMT+7)
- <https://api.dailysocial.net/en/wp-content/uploads/2012/08/eCommerce-in-Indonesia.pdf>
Accessed December 21st, 2016; 3:00 PM (GMT+7)
- <https://dailysocial.id/post/delivery-is-still-the-main-issue-for-indonesian-e-commerce/>
Accessed December 21st, 2016; 3:30 PM (GMT+7)
- Zeithaml, Valerie A, et al. 2009. Delivering Quality Service: Balancing Customer Perceptions and Expectations. Free Pr.
- Goodwin, P & Wright, G. 2009, Decision Analysis for Management Judgment 4th edition, Wiley
- <http://qcsm.com/the-qcsm-program/> Accessed December 22nd, 2016; 9:45 AM (GMT+7)



**THE INFLUENCE OF BUDGETARY COMMITMENT ON MANAGERIAL
PERFORMANCE: PARTICIPATIVE BUDGETING AS AN INTERVENING
VARIABLE**

Budi Hartono Kusuma

Faculty of Economics, University of Pelita Harapan

budi.kusuma@uph.edu

Abstract

The purpose of this study is to provide empirical evidence about the influence of budgetary commitment towards participative budgeting and the influence of participative budgeting towards managerial performance. The study also wants to prove the influence of budgetary commitment towards managerial performance through the mediation of participative budgeting. Collecting data in this study was conducted using a survey through questionnaires. Respondents were selected using purposive sampling in which respondents are structural officials at some universities which are located in West Jakarta, Banten, and Bandung. The structural officials should have minimum one-year term of experience and actively involved in the budgeting process. Eighty-seven respondents contributed in this study. The analysis technique used in this research is path analysis. The results revealed that participative budgeting has a positive influence on managerial performance. On the other hand, budgetary commitment has no influence on participative budgeting and the mediating effect of participatory budgeting has not been proven in this study. This study give contribution to managerial accounting literature especially in budgeting theory and also strengthen behavioral research literature.

Keywords: Budgetary commitment, participative budgeting, managerial performance.

JEL Classifications: M12



INTRODUCTION

Research Background

Planning and budgeting systems serve four main purposes which are planning, coordination, facilitating top management oversight, and motivation. A second purpose is coordination. The planning and budgeting processes force the sharing of information across the organization. The processes involve a top-down communication of organizational objectives and priorities, as well as bottom-up communication of opportunities, resource needs, constraints and risks. They also involve lateral communication that enhances the abilities of organizational entities working together toward common objectives. Everyone involved becomes more informed, so the process is more likely to result in decisions that consider all perspectives (Merchant and Stede, 2012).

A budget process is either “top-down” or “bottom up”. With top-down budgeting, senior management sets the budget for the lower levels. With bottom-up budgeting, lower-level managers participate in setting the budget amounts. The top down approach rarely works, however. It leads to a lack of commitment on the part of budgetees; this endangers the plan’s success. Bottom-up budgeting is most likely to generate commitment to meeting the budgeted objectives. Participative budgeting is especially beneficial for responsibility centers that operate in dynamic and uncertain environments because managers in charge of such responsibility centers are likely to have the best information regarding the variables that affect their revenues and expenses (Anthony and Govindarajan, 2007).

Highly achievable budget targets increase managers’ commitment to achieve the target. Most managers operate in conditions of considerable uncertainty; their performance is affected by many unforeseen circumstances. They have no choice but to commit to achieve their targets regardless of the business conditions faced. This increased commitment causes the managers to prepare their budget plans more carefully and to spend more of their time managing the budget. For example, Davis Service Group, a large public UK-based service contractor that sources, cleans and maintains industrial textiles, protective clothing and textiles, continued to be a profitable company despite the severe recession of 2008, presumably “as the result of careful budgeting (which) involves making detailed financial



plans for every aspect of the business, identifying risks and ensuring that managers are committed to the outcomes that they have agreed. (Merchant and Stede, 2012).

Participative budgeting research that investigates the relationship between budget participation and performance reveals significantly positive relationships, non-significant relationships, and some even reveal negative relationships. The majority of the participative budgeting literature examines the moderating and mediating effects that certain factors or variables have on the participation performance linkage. These moderating and mediating effects include factors such as locus of control, job related tension, role ambiguity, motivation, and job difficulty. Shields and Shields (1998) believe that an investigation into the antecedents of participative budgeting is necessary to provide some insight to participative budgeting literature. Research conducted by Shields and Shields (1998) investigate the budgetary commitment as a possible antecedent of participative budgeting.

Neubert and Cady (2001) define program commitment as a measure of attachment to a specific program or initiative of planned scope within the organization. Program commitment in their study refer to budgetary process. In an attempt to research antecedent variables, Neubert and Cady (2001) investigated program commitment and its association with organizational outcomes and a set of potential antecedents because they believed that the success of organizational programs could be achieved by obtaining the commitment of employees to these programs. The researchers tested a number of hypotheses related to program commitment and its effects on participation and performance. Neubert and Cady (2001) conducted two longitudinal studies; the first focused on program commitment and outcome variables, and the second focused on program commitment and its antecedents. In the first study, Neubert and Cady hypothesized that program commitment would be positively associated with participation and performance and that participation would mediate the relationship between program commitment and performance. In the second study, the researchers hypothesized that both compliance perceptions (e.g. rewards, leader behavior, and co-worker behavior) and affective perceptions (e.g. organizational commitment, change efficacy, and teamwork orientation) would be positively associated with program commitment.



In general, Breaux (2004) hypothesize that an individual's program commitment is positively associated with his/her degree of participative congruence, and this association has a positive effect on performance. In addition, individual and situational factors theorized to affect an individual's program commitment are examined. Thus, Neubert and Cady (2001) conducted two longitudinal studies, while Breaux (2004) studied it as a whole.

This research was conducted to give empirical evidence of the mediating effect of participative budgeting on the influence of program commitment towards managerial performance, as the first stage of Neubert and Cady's two longitudinal studies. Commitment also has positive effects on job performance. This link to performance appears to be stronger for managers and professionals (Hitt et al., 2015). This research focuses on private university where lecturers as professionals become the respondents.

This research gives contribution to enrich managerial accounting literature especially in budgeting theory. Understanding the factors that have influence to managerial performance is crucial. The study to prove that budgetary commitment as one of the factors in achieving better managerial performance can help the private universities in their planning process. Commitment causes managers to participate in budgeting process which in turn can increase overall managerial performance.

This research tries to answer the question: Does budgetary commitment have positive influence on managerial performance through mediation of participative budgeting? In order to answer this question, the positive influence of budgetary commitment on participative budgeting and the positive influence of participative budgeting on managerial performance are needed to know. Purposes of this research are to give the empirical evidence about the positive influence of budgetary commitment on managerial performance through mediation of participative budgeting.

Literature Review and Hypothesis Development

Budgetary Commitment

Neubert and Cady (2001) conceptualized the idea of "budgetary commitment," based on the traditional goal commitment construct. Their research responded to the need for a



measure of attachment to a specific program or initiative of planned scope within an organization. Neubert and Cady (2001) described the benefit of measuring budgetary commitment as being "a psychological attachment to the overall goals of a program rather than commitment to individual performance goals". The advantage of using a specific construct to measure one's attitude toward a program assignment, such as a budget process, may be more beneficial in measuring commitment (Breux, et al. 2011).

Participative Budgeting

Participative budgeting allows subordinate managers considerable say in how the budgets are established. Participative budgeting communicates a sense of responsibility to subordinate managers and fosters creativity. Since the subordinate manager creates the budget, the budget's goals will more likely become the manager's personal goals, resulting in greater goal congruence (Mowen, Hansen, and Heitger, 2016). Research conducted by Shield and Shield (1998) revealed that participative budgeting is the most important tool for planning and control. Participatory budgets empower subordinates and make them more accountable for their actions and outcomes (Gonçalves, 2013; Boulding and Wampler, 2010) through decentralization and delegation of authority (Bland, 2011; Boulding and Wampler, 2010). In addition to the fact that budgetary participation allows superiors to obtain relevant information, the existence of communication and discussion between superiors and subordinates allows them to clarify objectives and methods (Parker and Kyj, 2006).

Managerial Performance

Managerial performance is defined as management know-how, which is assumed to reflect management-specific skills and knowledge, without regard to the kind of business (Kariv, 2009). Managerial performance based on management functions, namely the extent to which the manager is able to carry out management functions which include planning, investigation, coordination, evaluation, supervision, staffing, negotiation, and representatives (Mahoney 1963 in Giri 2014).



Budgetary Commitment, Participative Budgeting, and Managerial Performance

Neubert and Cady (2001) found that program commitment (i.e., commitment to a specific program), not goal commitment (i.e., commitment to the attainment of specific goals), leads to higher participation, which in turn leads to higher performance. Research conducted by Breaux (2004) cannot provide evidence to support the finding of Neubert and Cady (2001). According to literature review, the proposed hypothesis is:

H₁ Budgetary commitment has positive influence on managerial performance through mediation of participative budgeting.

As explained in research question, there are two additional hypotheses to support the above hypothesis. Neubert and Cady (2001) conclude that program commitment leads to participation in budgeting process. The effects of program commitment in the participative budgeting setting should be investigated because it is a variable of interest not previously investigated in the participative budgeting literature (Breaux, 2004). The study of Breaux (2004) results that there is a significantly positive relationship between program commitment and the degree of participative. Research conducted by Indriantoro (1993), Frucot and Shearon (1991), Brownell and McInnes (1986), and Brownell (1982) revealed that there is a positive relationship between participative budgeting and managerial performance. Sugiyanto and Subagiyo (2005), Indarto and Ayu (2011), Leach-Lopez et al. (2007), Venkatesh and Blaskovich (2012), Rani (2013), Soleha et al. (2013), Lina and Stella (2013), and Lina (2015) found that participative budgeting has positive influence on managerial performance. Tapatfeto (2013) revealed that the higher the budgeting participation, the higher the performance of the manager. Reynaldhie and Mahmudi (2016) also found that participative budgeting has positive influence on managerial performance. Research conducted by Breaux (2004) found that degree of participating budgeting statistically has no influence on managerial performance.

H_{1a} Budgetary commitment has positive influence on participative budgeting.

H_{1b} Participative budgeting has positive influence on managerial performance.



RESEARCH MODEL

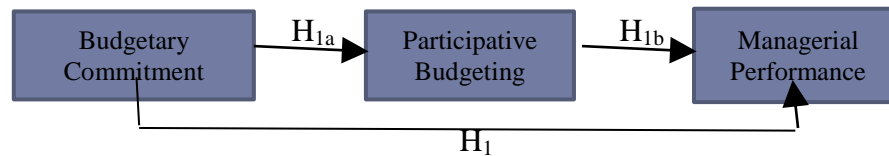

Figure 1. Research Model

RESEARCH METHOD

Research Data

Data used in this research is primary data that obtained through questionnaires. Purposive sampling method is used to select the respondent with criteria: at least one year of experience as a structural official in private universities which are located in West Jakarta, Banten, and Bandung. The structural officials should have minimum one-year term of experience and actively involved in the budgeting process.

Data Analysis

Statistic Descriptive Test

Descriptive statistics provide an overview of the demographics of respondents. This test shows the descriptive of age, gender, duration in structural position, and educational background of participated respondents.

Data Quality Test

Validity Test

Validity test used to measure whether or not a legitimate or valid questionnaires. A questionnaire considered valid if the questions in the questionnaire were able to reveal something that will be measured by the questionnaire (Ghozali, 2008). Testing the validity of this research will be using bivariate correlation between the respective indicator scores with a

total score of the construct. The bivariate correlation with the view of Pearson correlation coefficients.

Reliability Test

Reliability is actually a tool to measure a questionnaire which is an indicator of variables or constructs. A questionnaire said to be reliable or reliable if someone answers the statement is consistent or stable over time (Ghozali, 2008). A construct or a variable value said to be reliable if the Cronbach alpha > 0.70 (Nunnally 1994 in Ghozali, 2008).

Hypothesis Test

Coefficient Correlation Test

Correlation coefficient was used to test the hypothesized relationship between one or more independent variables with the dependent variable. The correlation coefficient ranges from 0-1. If approaching 1, the correlation becomes stronger, but if close to 0, the correlation became weaker (Ghozali, 2008).

Coefficient Determination Test

The coefficient of determination (R²) is used to determine how well the research model can be described by the dependent variable. In other words, the value of R² indicates how big the movement of the Y that can be explained by the movement of the independent variables (X). The coefficient of determination ranges between 0 (zero) to 1 (one). R² value of small means the ability of the independent variables in explaining the variation of the dependent variable is very limited. Value close to 1 (one) means the independent variables provide almost all the information needed to predict the variation of the dependent variable. (Ghozali, 2008).



Path Analysis

t tests were used to determine the influence of the independent variables towards dependent variable. Significance level is 0.05. To test the mediation effect, this research uses path analysis. The path coefficients are standardized regression coefficients.

Definition and Measurement of Variable Operational

Budgetary Commitment

Budgetary commitment describes the level of individual commitment during the budgeting process. This variable consists of 6 items on 5-point likert scale. This scale developed by Hollenbeck et al. (1989) and modified by Neubert and Cady (2001).

Participative Budgeting

Participative budgeting is a budgeting process under which those people impacted by a budget are actively involved in the budget creation process. This variable consists of 5 items on 5-point likert scale. This scale is adopted from Milani (1975) and modified by Venkatesh and Blaskovich (2012).

Managerial Performance

To measure managerial performance, this research uses 8 items on 5-point likert scale. This scale developed by Mahoney et al. (1963) in Giri (2014). Some researchers have validated this scale such as Brownell (1982), Brownell and Hirst (1986), Brownell and Dunk (1991), Neubert and Cady (2001), Chong and Chong (2002), Wentzel (2002), Breaux, et al. (2011), Indarto and Ayu (2011), Leach-Lopez *et al.* (2007), Rani (2013), Soleha *et al.* (2013), Venkatesh and Blaskovich (2012), Lina and Stella (2013), and Lina (2015).



RESULT AND DISCUSSION

Data Collection and Sample Selection

The data collected were primary data. Data collection is done by sending a questionnaire to the respondent by direct delivery or by sending via email. Here is presented a summary of the questionnaires were distributed and used in this study.

Table 1.
Questionnaires Summary

Description	Amount
Distributed questionnaires	120
Accepted questionnaires	92
Incomplete questionnaires	5
Used questionnaires	87

Descriptive Statistic

The following is descriptive statistic of respondent demographic.

Table 2.
Demographic of Respondent

Demographic	Value in percentage
Number of respondent	87
AGE	
Mean	40.48
Interval	27-65
Median	41.50
Deviation Standard	7.97
GENDER	
Male	46 (52.8%)
Female	41 (47.2%)



DURATION IN STRUCTURAL POSITION (IN YEAR)	
Mean	5.39
Interval	1-30
Median	4
Deviation Standard	5.45
EDUCATION LEVEL	
S1	12 (13.8%)
S2	58 (66.7%)
S3	17 (19.5%)

Data Quality Test

Validity Test

Through pearson correlation test, we will get the r count. r count will compare to r table with significance level at 5% and degree of freedom = $n - 2 = 87 - 5 = 85$. If r count is greater than r table, it means that all questions or all statement are valid.

1. Budgetary Commitment

The result of validity test shows that all statements are valid because r count greater than r table.

Table 3.
Validity Test Result – Budgetary Commitment

Statement Number	r count	r table	Description
1	0.655	0.211	Valid
2	0.375	0.211	Valid
3	0.313	0.211	Valid
4	0.636	0.211	Valid
5	0.365	0.211	Valid
6	0.710	0.211	Valid



2. Participative Budgeting

Table 4.

Validity Test Result – Participative Budgeting

Statement Number	r count	r table	Description
1	0.712	0.211	Valid
2	0.814	0.211	Valid
3	0.771	0.211	Valid
4	0.808	0.211	Valid
5	0.817	0.211	Valid

According to table above, r count of all statements are greater than r table. It is means that all statements are valid.

3. Managerial Performance

All statements are valid because r count is greater than r table.

Table 5.

Validity Test Result – Managerial Performance

Statement Number	r count	r table	Description
1	0.680	0.211	Valid
2	0.628	0.211	Valid
3	0.593	0.211	Valid
4	0.693	0.211	Valid
5	0.625	0.211	Valid
6	0.283	0.211	Valid
7	0.286	0.211	Valid
8	0.568	0.211	Valid

Reliability Test

Reliability test result of all variables in this research can be shown in table below.

Table 6.
Reliability Test Result

Variable	Cronbach's Alpha	Description
Budgetary Commitment	0.481	Quite Reliable
Participative Budgeting	0.827	Reliable
Managerial Performance	0.503	Quite Reliable

Hypothesis Test

This research cannot support the H_{1a} with the significant value of 0.198. It means that budgetary commitment has no influence on participative budgeting. This result inconsistent with the research result of Neubert and Cady (2001) and Breaux (2004). R value is 0.139, it shows weak relationship between budgetary commitment and participative budgeting. R^2 is 0.019, it means that the variation of dependent can be explained by the variation of independent variable 1.9% and the rest can be explained by other variables that not included in this research.

This research provides evidence to support H_{1b} . The significant value of H_{1b} is 0.000 and the unstandardized coefficient value is 0.373. It means that participative budgeting has positive influence on managerial performance. R value is 0.543 that means there is strong relationship between participative budgeting and managerial performance. R^2 is 0.295, it means that 29.5% of the variation of dependent variable can be explained by the variation of independent variable while the rest can be explained by other variables that not included in this research. The result consistent with Sugiyanto and Subagiyo (2005), Indarto and Ayu (2011), Leach-Lopez et al. (2007), Venkatesh and Blaskovich (2012), Rani (2013), Soleha et al. (2013), Lina and Stella (2013), Tapatfeto (2013), Lina (2015), and Reynalddie and Mahmudi (2016). Research conducted by Breaux (2004) found different result that degree of participating budgeting statistically has no influence on managerial performance.



Standardized beta value of direct effect of budgetary commitment on participative budgeting is 0.139. Standardized beta value of direct effect of participative budgeting on managerial performance is 0.543. The indirect effect of budgetary commitment on managerial performance through the mediation of participative budgeting is 0.075. This value is lower than the standardized beta value of direct effect of budgetary commitment on managerial performance which is 0.360. It shows that this research cannot prove the mediating effect of participative budgeting on the influence of budgetary commitment towards managerial performance. This result is consistent with Breaux (2004) and inconsistent with Neubert and Cady (2001).

As indicated in the result of H_{1a} where program commitment (to be specific called as budgetary commitment) has no influence on participative budgeting, it means when an individual committed to a program such as budgetary process, this condition does not give the guarantee that he/she will participate seriously in participative budgeting process. The employees may committed to the program because of their daily tasks but they might not be realized the potential benefit of participate all out in the whole budgetary process.

H_{1b} shows that participative budgeting has positive influence on managerial performance. The higher the employees involved in budgetary process, the higher the performance will be. Individual perceives that participation in budgeting process can positively influence his or her self-rated performance.

This study has no evidence to prove the mediation effect of participative budgeting on the influence of budgetary commitment towards managerial performance. Commitment to prepare the budget is only part of the organizational commitment which is define as a broad attitude toward the organization as a whole.

CONCLUSION, LIMITATION, AND RECOMMENDATION

The mediating effect of participative budgeting on the influence of budgetary commitment towards managerial performance cannot be proved through the result of this research. Participative budgeting has positive influence on managerial performance. Budgetary commitment has no influence on participative budgeting.



The distribution process of questionnaires has not been spread evenly throughout Indonesia. The future research will be more meaningful if the distribution of the questionnaire can be expanded to all private universities throughout Indonesia. This study cannot prove the mediating effect of participative budgeting on the influence of budgetary commitment towards managerial performance. It means that there are still other mediating variables that can be further investigated. The use of other mediating variables or moderating variable in future study is also possible such as job satisfaction, motivation, and leadership style.

REFERENCES

- Anthony, RN & V Govindarajan, (2007), *Management Control Systems*, 12th Edition, McGraw-Hill Education. Singapore, Chapter 9.
- Bland, G. (2011), "Supporting Post-conflict Democratic Development? External Promotion of Participatory Budgeting in El Salvador, World Development", Available at <http://www.sciencedirect.com/science/article/pii/S0305750X100017>.
- Boulding, C. & Wampler B, (2010), "Voice, Votes, and Resources: Evaluating the Effect of Participatory Democracy on Well-being. World Development", Available at <http://www.sciencedirect.com/science/article/pii/S0305750X09000953>.
- Breaux, KT. (2004), "The Effect of Program Commitment on the Degree of Participative Congruence and Managerial Performance in A Budgeting Setting", Dissertation.
- Breaux, KT., DW. Finn, & A Jones III, (2011), "Budgetary Commitment as a Mediating Influence", *Journal of Managerial Issues*, Vol. 23, No. 4, pp. 426-446.
- Brownell, (1982), "Participation in the Budgeting Process - When It Works and When It Doesn't", *Journal of Accounting Literature* (Spring), pp. 124-153.
- Brownell & A. S. Dunk, (1991), "Task Uncertainty and its Interaction with Budgetary Participation and Budget Emphasis: Some Methodological Issues and Empirical Investigation", *Accounting, Organizations & Society* 16(8), pp. 693-703.
- Brownell & M. Hirst, (1986), "Reliance on Accounting Information, Budgetary Participation, and Task Uncertainty: Tests of a Three-way Interaction", *Journal of Accounting Research* 24 (2), pp. 241-249.



- Brownell & M. McInnes, (1986), "Budgetary Participation, Motivation, and Managerial Performance", *The Accounting Review* 61(4), pp. 587-600.
- Chong, V. K. & K. M. Chong, (2002), "Budget Coal Commitment and Informational Effects of Budget Participation on Performance: A Structural Equation Modeling Approach", *Behavioral Research in Accounting*, Vol 14, pp 65 - 86.
- Frucot, V., & W. T. Shearon. (1991), "Budgetary Participation, Locus of Control, and Mexican Managerial Performance and Job Satisfaction", *The Accounting Review* 66 (January), pp. 80-98.
- Ghozali, I, (2008), *Structural Equation Modeling, Metode Alternatif dengan Partial Least Square*. Semarang: Badan Penerbit Universitas Diponegoro.
- Giri, MDBW, (2014), 'Pengaruh Partisipasi Penganggaran pada Kinerja Manajerial dengan Keadilan Distributif, Keadilan Prosedural, dan Komitmen Tujuan Anggaran Sebagai Variabel Pemediasi', *Tesis*, Universitas Udayana, Dapat diakses melalui http://www.pps.unud.ac.id/thesis/pdf_thesis/unud.
- Gonçalves, S, (2013), "The Effects of Participatory Budgeting on Municipal Expenditures and Infant Mortality in Brazil. *World Development*". Available at <http://www.sciencedirect.com/science/article/pii/S0305750X13000156>.
- Hitt, MA., CC. Miller, and A. Colella, (2015), *Organizational Behavior*, John Wiley & Sons.
- Hollenbeck, J. R., H.J. Klein, A. M. O'Leary, & P. M. Wright, (1989), "Investigation of the Construct Validity of a Self-Report Measure of Goal Commitment". *Journal of Applied Psychology* 74(6), pp. 951-956.
- Indarto, SLI & SD Ayu, (2011), "Pengaruh Partisipasi Dalam Penyusunan Anggaran terhadap Kinerja Manajerial Perusahaan Melalui Kecukupan Anggaran, Komitmen Organisasi, Komitmen Tujuan Anggaran, dan Job Relevant Information", *Seri Kajian Ilmiah*, Volume 14, Nomor 1, pp. 32 - 44.
- Indriantoro, N, (1993), "The Effect of Participative Budgeting on Job Performance and Job Satisfaction with Locus of Control and Cultural Dimensions as Moderating Variables", *Dissertation*.



- Kariv, D., (2009), “Managerial Performance and Business Success: Gender Differences in Canadian and Israeli Entrepreneurs”, *The Journal of Enterprising Communities: People and Places in the Global Economy* (JEC), 2(4), pp. 300-331.
- Leach-López, MA., WW. Stammerjohan, & KS Lee, (2007), “Budget Participation and Job Performance of South Korean Managers Mediated by Job Satisfaction and Job Relevant Information”, *7th Global Conference on Business & Economics*, Rome Italy.
- Lina & Stella, (2013), “Pengaruh Partisipasi Penyusunan Anggaran terhadap Kinerja Manajerial: Kepuasan Kerja dan Job Relevant Information sebagai Variabel Intervening”, *Jurnal Bisnis dan Akuntansi*, 15(1), pp. 37 – 56.
- Lina, (2015), “Partisipasi Penyusunan Anggaran, Psychological Capital, dan Kinerja Manajerial”, *Jurnal Manajemen Teknologi*, Vol 14, No. 3, pp. 301-320.
- Merchant KA. & WAV. Stede, (2012), *Management Control Systems: Performance Measurement, Evaluation and Incentives*, Third Edition, Prentice Hall, Chapter 8.
- Milani, K, (1975), “The Relationship of Participation in Budget-setting to Industrial Supervisor Performance and Attitudes: A Field Study”, *The Accounting Review* 50(2), pp. 274-284.
- Mowen, M., DR. Hansen, & DL. Heitger, (2016), *Cornerstones of Managerial Accounting*, Sixth Edition, Cengage Learning, pp. 403-404.
- Neubert, M.J. & Cady, S.H, (2001), “Program Commitment: A Multi-Study Longitudinal Field Investigation of Its Impact and Antecedents”. *Personnel Psychology*, 54:2, pp. 421-448.
- Parker, R.J. & Kyj, L, (2006), “Vertical information sharing in the budgeting process. Accounting, Organizations and Society”, *Available at* <http://www.sciencedirect.com/science/article/pii/S0361368204000686>
- Rani, M, (2013), “Pengaruh Partisipasi Anggaran Terhadap Kinerja Manajerial: Locus of Control sebagai Variabel Moderating”, *Jurnal Ilmiah Universitas Bakrie*, Vol. 1, No. 2. http://journal.bakrie.ac.id/index.php/jurnal_ilmiah_ub/article/view/242.
- Reynaldhie, MT & Mahmudi, (2016), “Pengaruh Gaya Kepemimpinan, Komitmen Organisasi, Budaya Organisasi, dan Ketidakpastian Lingkungan dalam Memoderasi Hubungan Antara Partisipasi Anggaran terhadap Kinerja Manajerial. (Studi pada



- Perusahaan Manufaktur di Kota Gresik)”, *Prosiding Simposium Nasional Akuntansi XIX*, Lampung.
- Tapatfeto, JD, (2013), “Analisis Komitmen Tujuan dan Partisipasi Penyusunan Anggaran terhadap Kinerja Manajerial”, *Jurnal Akuntansi Multiparadigma*, Volume 4, Nomor 3, pp. 330-507.
- Shields, J.F. & Shields, M.D, (1998), “Antecedents of Participative Budgeting, *Accounting, Corporation, and Society*”, 23:1, pp. 49-76.
- Soleha, N, Galih, & Lusi T, (2013), “The Effect of Budgetary Participation on Job Performance with Psychological Capital and Organizational Commitment as An Intervening Variable (Empirical Study on Dinas Pendapatan dan Pengelolaan Keuangan Daerah Districts of Lebak)”, *Prosiding Simposium Nasional Akuntansi XVI – Manado*, pp. 1732 – 2142.
- Sugiyanto, E & L Subagiyo, (2005), “Pengaruh Partisipasi Anggaran terhadap Kinerja Manajerial: Komitmen Tujuan sebagai Variabel Intervening (Studi Empiris pada Rumah Sakit Tipe A, B, dan C di Jawa Tengah dan Daerah Istimewa Yogyakarta)”, *Benefit*, Vol. 9, No. 1, pp. 34 – 48.
- Venkatesh, R & Blaskovich, J, (2012), “The Mediating Effect of Psychological Capital on the Budget Participation – Managerial Performance Relationship”, *Journal of Management Accounting Research*, 24 (1), pp. 159 - 175.
- Wentzel, K, (2002), The Influence of Fairness Perceptions and Goal Commitment on Managers' Performance in a Budget Setting, *Behavioral Research in Accounting* 14, pp. 247 271.



FACTORING EMPLOYEE ENGAGEMENT OF FULL TIME LECTURERS

Yohana F. Cahya Palupi Meilani

Management Department, Pelita Harapan University, Indonesia

yohana.meilani@uph.edu

Abstract

Purpose of this study is to identify factors in employee engagement of lecturers at ABC University. Based on understanding that in order to have competitive advantage, an organization needs supported qualified human resources. Important qualified human resources in higher education is lecturer. Lecturers as talented people are expected to be motivated in their work and committed, enthusiastic, eager to do her/his job well. Then lecturers require some conditions that will lead to loyalty and survive in organization. Exploratory study conducted on 50 lecturers who work more than five years at ABC. The results obtained that 80% (40 lecturers) proud as lecturers of ABC now. Only 45% (23 lecturers) satisfied with the compensation and benefits. To discuss issue in depth, qualitative research method was conducted in this research. Through literatures studies, in-depth interviews, observation, that aim to get deeper information. Informants are two lecturers who had worked more than five years; Head of Departments as direct supervisor. Collecting data using triangulation method. Data was collected by interviewing two lecturers who had worked more than five years. Results shown that organizational support and relationship within organization has impact to employee satisfaction. While employee satisfaction has impact to build employee engagement. Research contributions provide input to higher education managers in managing lecturers as human resources to build employee engagement.

Keywords: *Employee Engagement, Motivation, Full time Lecturer*

JEL Classifications: *M12, D23*



INTRODUCTION

Work organization need supported of qualified human resources in order to have a competitive advantage. However the quality of an organization is determined by both quality of employees that will affect the performance and quality of the organization itself (Siagian, 2012). Lecturers as talented people, who are dealing with students in delivering the learning process, they are expected to be motivated in working and committed, enthusiastic, and passionate in doing her/his job. Performance of lecturers is basis for achieving the performance of organization. Each lecturer as faculty member should enriching performance by Tridharma. According Law No. 20 /2003 on National Education System that stated universities are obliged to provide three obligations to do, named Tridharma such as lecturing, research, and community service.

Lecturer Workload is main task of professional educator and scientist to transforming, developing and disseminating science, technology and the arts through education, research and community service (dikti.go.id, 2010). Because of that lecturer as an employee requiring some conditions that will lead to loyalty and survive in the University. Perception of lecturer is important to define because the perception is the process of giving meaning to the environment by individuals (Gibson et al, 2006). Conditions of lecturer engagement as an employee is a feeling that makes employees feel more enthusiastic about the work that tries to show her/his best performance, loyal and retain in the organization. This is in line with the statement Robins and Judge (2013) that employee engagement is an employee's positive attitude towards the values and goals of the organization. By having engaged workers, organization will try to have an understanding and awareness how to achieve its objectives in the long term.

Based on exploratory study conducted on 50 lecturers of ABC University who have worked more than five years showed that: 65% of lecturers felt always do something better than what was expected. Then 80% of lecturers feel proud to be part of ABC. Only 45% of lecturers satisfied with the compensation and benefit. Observations done on largest Faculty in ABC which has majority number of students, shows that in the period since the academic year 2008/2009 until 2013/2014 there has been a turnover of tenured faculty. For example in the period 2011/2012 the number of permanent lecturers were 34 persons, recruiting new



lecturers is four person. But lecturer turnover were seven person. Turnover more than 2% according Hasibuan (2007), can be ranked high. Some reasons are because family problems; wanted better salaries and benefits; changed careers; does not fit to organization culture.

On the other hand the data from the Education Minister expressed need of lecturers in Indonesia is still high. Meaning, that Indonesia is still has shortage of people who are interested and qualified as a lecturer. The number of lecturers in Indonesia reached about 160 thousand people, while the number of students reaching around 5.5 million (Desita, 2013). If allowed to continue, it is a dangerous potential to performance of the organization. Thus the employee engagement in ABC will be needed, because the organization needs the support and loyalty of the lecturer to achieve the objectives and improved organizational performance. Because according to Gallup (2010) that stated the employees who have engaged will be more productive. Previous research on employee engagement is done with quantitative methods titled “Employee Engagement: Antecedents and Consequences Unit Studies in PT. Telkom Indonesia Semarang” by Nusatria and Suharnomo (2011), analysis shows that the job characteristics, perceived supervisor support, appreciation and recognition has a positive influence. Some researchs also showed that employee engagement has a positive influence on job satisfaction and organizational commitment (Siddhanta and Roy, 2010; Lamidi, 2010; Nusatria and Suharnomo, 2011, Polii, 2015). The benefits of employee engagement can create success for the company through employee performance, productivity, safety, attendance and retention, customer satisfaction, customer loyalty, to profitability. Because of that employee performance can be one of the things that became a result of the creation of employee engagement. Therefore it is important to conduct research to identify factors build employee engagement of lecturers in ABC with a qualitative method approach to get deep insight perceptions from lecturers’ side.

Based on the background mentioned above it can be concluded that the issue became the focus of this issue is :

How are factoring employee engagement of lecturers at ABC University?



LITERATURES

Motivation

Human Resource Management (HRM) according Ivancevich (2010) is a program that is in direct contact with humans as an employee and helps employees achieve the goal of both organizations and individuals. HRM consists of several activities, such as: Fulfillment of equal employment opportunity; Job analysis; HR planning; recruitment, selection, motivation, and employee orientation; Performance evaluation and compensation; Training and Development; Industrial relations; Healthy safety work. In HRM, motivation is very important. To understand the motivation of employees cannot be ignored because it will encourage employee motivation achievement (Notoadmojo, 2009; Pentury, 2010). Motivation is the driving someone achieve the goal which man cannot be separated from the need and desire necessary to respond. Maslow's theory explains there are five levels of needs: physiological, safety, social, esteem, self-actualization. Later developed by Herzberg in motivation and hygiene factors. Equipped of view Aldefer known as ERG theory (existence, relatedness, growth). Hezberg in theory two factors stated factors such as policies, corporate administrations, and an adequate salary in a job will be to reassure employees. When these factors are not sufficient then people will not be satisfied. It can be interpreted person in carrying out his work is influenced by two factors is a requirement: (a)Hygiene Factors are factors relating to the maintenance of human nature that wants to obtain peace of corporal . The health needs of these is a requirement that is ongoing , because this requirement will be returned to the zero point after met; (b)Motivation Factors are the motivating factors concerning an individual's psychological needs that perfect feeling of doing the job. This motivational factor associated with an appreciation of the personal directly related with job (Aamodt, 2012) .

Job Satisfaction

Job satisfaction can be defined as an emotional state that is pleasant or unpleasant in which employees view their work (Hasibuan, 2007; Sunyoto 2009). Sutrisno (2009) also stated the factors which may influence job satisfaction such as: (1)The psychological factor is



related to the psychology of employees, such as interests, tranquility in the work, the attitude of the work, talent, and skills. (2)The social factor that is associated with the interaction between the employee or the employer. (3)Physical factors are associated with physical conditions that exist in the workplace such as type of work, rest periods, work equipment, state of the room, temperature, lighting, air vents. (4) The financial factor that is associated with the guarantee as well as employee benefits, including salaries, benefits (social security, benefits, facilities, promotion). If the organization motivate employee well, the employee will feel a positive condition and is satisfied that they would be willing to do more than expected performance (Sugandi et al., 2013; Meilani, 2009). However, employees can also feel the condition of dissatisfaction that according to Robbins and Judge (2009) may be manifested in the form such as:(1) Exit, namely through behavior leads to leave the organization or resign; (2)Voice, through the efforts of actively and constructively trying to improve the situation, including suggested improvements, discuss the matter with his superiors. (3)Loyalty, shown passively, remains optimistic about waiting for the conditions to improve, even defended the organization if there is criticism and trust organizations and management did the right thing. (4) Neglect, ie the act of letting the condition gets worse, such as defaulter, often too late, reducing the effort in working, errors in work increases.

Organizational Support

Organizational support is arise where organizations face a dynamic and changing environment in order to adaptation organizations themselves. The organizational support is experienced which employees believe their contributions rewarded and concerned by organizations. Precious research shows people feel their organization is supportive when awards consider fair, employees can participation in decisions and if they were considered supportive supervision. If the perceived organizational support and commitment strong and positive it is likely to give high job satisfaction (Hasibuan, 2007; Sunyoto 2009; Robbins and Judge,2009).



Employee Engagement

Employee engagement is a complex problem in HRM. If organization wants to have a competitive advantage, require employees with good performance and restraints. The reason is employee engagement will make employees feel happy and enthusiastic to work in well performance (Handoko, 2010). Employee engagement can be divided into three aspects: physical / personal , emotional and cognitive aspects . The physical aspect is the level of engagement in person with the organization. Emotional aspects can be realized with a condition in which the employee is willing to cooperate or to empathize with superiors and colleagues. The cognitive aspect is the awareness of the role played by the organization. Characteristics on employee engagement related to the organization's efforts in improving employee performance and organizational performance (Robbins and Judge , 2009).

Loyalty

Loyalty is a condition of the willingness of employees in order to have a long association with the company. Loyal employees will be loyal in the long term, even to defend and keep the organization from a statement that is not good (Robbins, 2013 ; Siagian, 2012; Hasibuan, 2007) that loyal employees will be loyal in the long term, to defend and keep the organization from a statement that is not good. In the study Soegandi et al (2013) concluded that employee loyalty is positive and significant impact on Organizational Citizenship Behavior employees, although the effect is weaker than job satisfaction.

RESEARCH METHOD

The method used is qualitative, based on the philosophy post positivism, used to examine the condition of natural objects. Data analysis inductive and qualitative research results further emphasize the significance rather than generalization. Qualitative research is a method of unstructured exploratory research that is based on a small sample that provides insight and understanding of a problem situation. This is in line with Sugiyono (2007) and Creswell (2009) adds that qualitative research is the excavation effort, understanding, and meaning to what happens in the various individuals or groups, who comes from a social or humanitarian issues. The purpose of qualitative research is helping researchers to deepen



existing social phenomena through the perspective gained from key informants who have been determined. The object this research is lecturer of ABC. Data collection method used by conducted through: direct observation method (observation), the method of using questions (interview), special method (questionnaire for exploration) and also secondary data derived from the theories, the company archives or previous research (Nazir, 2007; Ihalauw, 2008). In this study, the unit of analysis that will be studied is individual. Because this paper discusses factoring employee engagement of fulltime lecturers.

The selected key informants in this study are lecturers with period of work more than five years. The consideration is during five years work at ABC able to provide an overview of the process that is received from ABC. Observations made on the key informant at the facts that occurred to see how the ways in building employee engagement factors at ABC. Both key informants election conducted with consideration of ease gain access to data and their availability and willingness. However, both informant only willing to use the name initials disguised as Mr X and Mrs Y, this is done as privacy because they still work at ABC University.

This research using triangulation, is done by combining data obtained from various sources. The source can be either from the observation, key informant interviews, and secondary data derived from the theory, the company archives or previous research. This is done to reduce error and bias. While the validity of the use Validity is the degree of accuracy of the data occurs in a research project with data that can be reported by researchers (Sugiyono, 2008). Validity can be divided into three, namely (Yin, 2003): (1)Construct validity: establishing correct operational measures for the concepts to be studied. (2)Internal validity: establish causality, where certain conditions are shown in order to direct other conditions, as distinguished from a pseudo relationship.(3)External validity: set the realm in which the findings of a study can be generalized. This study uses an external validity test, which put more emphasis on the extent to which these results can be generalized to other contexts.



Key Informant Profiles

Through informant profiles can be understood that the two speakers are lecturers with tenure period of employment more than five years; age over 40 years; married; has national registration number of lecturer named NIDN, has formal academic hierarchy named *Jenjang Jabatan Akademik* (JJA), lecturer certification; and S2 of from domestic (Indonesia) graduates. According to Indonesia's regulation concerning the terms of lecturers in Indonesia should have minimum S2 (magister degree) can be a full-time lecturer for S1(bachelor degree).

The first informant is male (Mr. X), aged 48 years old, period of work is five years. Although not yet have a doctoral degree, but already has JJA rank as lector 300. In the competence level of the position still further towards to be a Professor. Especially in an academic environment there are still unwritten cultural and views about different treatment based on the status of academic or graduate level. As a Magister degree, first informant although deemed to have seniority, but should still be trying to get recognition and privileges attached as a senior lecturer. Especially in the age of 48 years, the first informant in his performance required to be more competent in teaching and others good personal competence to survive. But JJA rank lector and lecturer certification still required for the profile lecturers in department/faculty, so he still has strong enough bargaining position.

The Second informant is female (Mrs. Y), aged 40 years old, period of work is 9 years, holding Magister degree. In the competence of the ladder is at the lowest level for the profession of lecturers as Asisten Ahli 150(AA). But the second speaker still has the opportunity and the desire to continue doctoral education level. Which is an added value for both speakers are already have professional certification (serdos) so shall doing and reported Tridharma regularly. Collecting data in this study conducted using interviews and observation. Interviews were conducted in all informants in a different time. Then proceed to observations and Focus Group Discussion (FGD) with Head of Departments.

FINDING AND DISCUSSION

Based on FGD with head of departments as a direct supervisors of key informants that considers even though lecturer not yet has emotional engagement, but it is already happening



cognitive engagement and behavioral engagement. This can be explained based on observations that ABC has standardized system in employee socialization. Then an understanding of the vision, mission, goals, strategies, both at the organizational level and the level of department delivered in a comprehensive, holistic and periodically to the lecturer through training and seminars and regular meetings. So lecturers know what the obligations, the job description which impact on attachment behavior. Supported by the rules in force in accordance rule book published by the Human Resources Department of ABC as a guidance in the operational followed by lecturers to do the job including Tridharma elements. This is according to a statement by Rusdin (2013) and Mc. Bain (2007) that stated employee engagement include attachments cognitive, emotional, and behavior that is not optimal can also contribute positively and significantly to improve organizational performance. Because engagement related cognitive emotion felt by individuals as a result of an engagement of the situation. So that employee engagement built through a long process and requires management support and conducive leadership. Lecturers who have an attachment to consciously or emotionally connect with the leaders.

Based on observations and literatures review, as a private university ABC known have good facilities in Indonesia. Such as modern learning facilities of laboratories, digital libraries, e-libraries, as well as sports and arts facilities (gym, football field, track, field athletes and various facilities concerts). As an education provider for S1 dan S2, has approximately 400 full-time lecturers and graduate S2, S3 graduates from domestic and overseas. Spiritually committed to developing students with the development of character and knowledge. Basic recruitment believes the importance of placement in the right position in the management of international standard education. Then the lecturer is a key factor in increasing knowledge and interest of students in science. ABC's organizational culture is very strong and visible management role in decision making top-down management. Therefore, the existing norms follow the vision and mission that is constantly trained to the employees. Starting from the orientation of the new employees are given directly by the top managerial ranks of the rector. To better understand these norms also confirmed by written rules on employee regulations are reviewed every three year by the HR Department. Kotler (2000) states that a positive organizational culture will lead to organizational commitment. It



is expected that lecturers can see himself in the positive values of the organization to then take an active role in achieving the objectives of the University. ABC shows through the existing norms established organizational commitment organizational trust lecturer and vice versa. Further organizational commitment will assist the employees in this case a lecturer in running performance. The following will be presented table informant interviews regarding the issue of research.

Table 1. Results of Both Informants Interviews

Research Questions	First Informant (Mr. X)	Second Informant (Mrs. Y)	Category	Pattern and Variables
1. Meaning of your work?	<i>Very meaningful, because it is my profession.</i>	<i>Through my job trying to glorify God .</i>	Meaningful, Glorified God.	The informants are lecturers who are work more than five
2. How does working facilities obtained ?	<i>The facilities are very good comfortable to work with computers , office equipment</i>	<i>Appropriate and good to do a good job in the classroom and in the private office.</i>	Good. Comfortable for work in classroom and private office.	years and each person has NIDN, JJA, Lecturer certification from Government as recognition of their professional
3. How rights taken?	<i>adequate and nice .</i>	<i>Once was not given hospitalized for my children, but clear after knowing the procedure.</i>	Given as promised and as procedur	ism. They
4. What		<i>Others is ok.</i>	e.	



personal relationship with head of department ?		<i>Mediocre, more important to do the job properly.</i>	Formal and mediocre.	feel that work at ABC meaningful and can glorified God through job. They obtained organization al support such as good and comfortable working facilities, the rights given as promised procedurally . Personal relationship with direct supervisor (head of department) is mediocre, formal just for working. But
5. What personal relationships with colleagues ?	<i>Least once a week we meet if there are weekly worship, formal just for work.</i>	<i>Friend like a brother/sister. If differences of opinion also does nothing .</i>	Strong relationships ip to supported .	
6. How is the training available?	<i>same team supported each other .</i>	<i>Training is supported inside or outside that can be accounted in favor of competence teaching or research .</i>	Provided and supported by organizati on.	
7. How do you get development process?	<i>training provided either internal/external .</i>	<i>There is also spiritual development so lecturers know the purpose of his/her life.</i>	Self learning; spiritual	
8. How can	<i>JJA up. Only Developing self-</i>	<i>Some accepted</i>		



appreciation for your idea ?	<i>learning.</i>	<i>and some are not accepted.</i>	formation .	relationship with colleagues is very strong and supported each others. Training and development provided by organization through internal and external training.
9. How is the income received compared to the workload ?	<i>Accepted well but implementation depend on supervisor.</i>	<i>is good.</i>	Accepted but depend on superviso r.	
10. How do the financial support Tridharma?	<i>Just ordinary enough.</i>	<i>Supported with a budget that is controlled by superiors</i>	Enough and good.	
11. How is the working Environment ?	<i>Conducive because many rules and regulations.</i>	<i>Very Satisfied.</i>	Supporte d with strict supervisi on.	Developme nt done by the informants self learning, organization also supported on spiritual training.
12. How is your satisfaction ?	<i>Satisfied.</i>	<i>Medium</i>	Conduciv e good environm ent.	
13. How is the cooperation	<i>Not bad for cooperation at work.</i>	<i>encouragement , but among employee building their</i>	Satisfied.	Compensati on and



among employees?		<i>relationship naturally.</i>	Teamwork is good.	benefit feel enough and good. For example
14. How head of department encouraged cooperation?	<i>Not really involved to encouraged, but teamwork is well.</i>	<i>I do research, teaching, community service regularly and achieve good performance.</i>	Not involved; Among employee build their relationship naturally. Doing Tridharma a well and achieve good performance.	Financial supported to do Tridharma by strict controlling and supervision of superior. Both informants feel satisfied and believe that working can running well by teamwork. The superior (head of department) not significantly involved to encouraged teamwork thus among
15. How is your work performance?	<i>Good enough I do my duties and Tridharma well.</i>	<i>Often, for job and students needed.</i>	I will give good recommendation for Christian University. I can accepted.	
16. Do you willing to work over office hours?	<i>Yes, sometimes when job needed.</i>	<i>Yes, but depend on your expectation especially for Christian spirituality.</i>		
17. Do you recommend ABC as a good place to work?		<i>It is okay, every workplace have</i>		
18. How do		<i>values.</i>	Give	



you face the weakness of your organization?	<i>it.</i>	<i>As lecturer I should explore to do better in job.</i>	good recomme ndation for Christian Universit y.	lecturers building their relationship naturally.
19. How do you face organization culture?	<i>I am not stay, so I feel match.</i>	<i>It doesn't matter if the managerial</i>	Okay and can accepted.	Tridharma (teaching, research and publication, community service) as work performance of teacher can done and achievable, because the informant willing to work over office hours for job and students needed. They will good recommend ation for Christian
20. How do you explore yourself in work?	<i>I always learning to be innovative in teaching.</i>	<i>explain the standard clearly.</i>	Match my values.	performance of teacher can done and achievable, because the informant willing to work over office hours for job and students needed. They will good recommend ation for Christian
21. How do you see the goal of your department?	<i>sometimes confusing.</i>	<i>Yes, it is okay I think</i>	Explorati on by innovatio n way to teaching.	performance of teacher can done and achievable, because the informant willing to work over office hours for job and students needed. They will good recommend ation for Christian
22. Do you proud of ABC?	<i>Yeah I am Proud.</i>	<i>Yeah I am Proud.</i>	Very dynamic and confusing if there isn't	performance of teacher can done and achievable, because the informant willing to work over office hours for job and students needed. They will good recommend ation for Christian
23. Why do	<i>I will as allowed by God.</i>	<i>I will as allowed by God.</i>	Very dynamic and confusing if there isn't	performance of teacher can done and achievable, because the informant willing to work over office hours for job and students needed. They will good recommend ation for Christian



<p>you still work at ABC in the next ten years?</p>	<p>explain standard clearly. Proud. Willing stay and loyal as allowed by God</p>	<p>university good place to work. They stand until now in ABC because feeling match with their values. They also explore innovative way to teach although goal of department very dynamic, they can accepted if supervisor can explain it clearly. Then informants proud and feel happy work at ABC as</p>
---	---	--



God
allowed.
From the
patterns on
variables
that arise
include :

1. Organizational Support
2. Relationship within organization
3. Employee Satisfaction
4. Employee Engagement

Source : Interview Protocol

Present findings based on interview with informants, they are stated that there is organizational support at ABC such as good and comfortable working environment; given right as promised; fairly financial compensation and benefit; financial support to do Tridharma). Based on observation there are good facilities to work such as private room, provided personal computer with WIFI supported, working stationary. And ambient such as good cafeteria, futsal and soccer field, gym, swimming pool, green garden. Good library. The classroom itself provided some equipment such as whiteboard, LCD, computer and WIFI. Thus employee feel happy to work and as lecturers they can perform well to do teaching, research and community service. Related Sutrisno (2009) that stated it can be categorized as



physical aspect of employee engagement. The physical aspect is the level of engagement in person with the organization can be named as personal engagement. ABC doing human resource management well start from recruiting phase that can be implied from the fit values between informants as lecturers (individual) and organization. In this case informants admit that they are not only taken several internal and external training that supported them doing job well as lecturers. They also taken spiritual side to development from training by Leadership Enrichment Module (LEM) that offering modules to be more integrative as a Christian lecturers in Christian worldview. ABC know the important of employee motivation through good HRM, in line with Pentury, 2010 that stated understand the motivation of employees cannot be ignored because it will encourage employee motivation achievement. Through motivation and organizational support both informants has positive perception toward work and work place (ABC). They feel satisfied, then they want to work more than work hours, try to be innovative at teaching. Based on Sutrisno (2009) there are factors that influence job satisfaction include (1)social factor: implied on good relationship among employee and good teamwork; (2)physical factors. are associated with physical conditions that exist in the workplace such as type of work, rest periods, work equipment, state of the room, temperature, lighting, air vents. (4) the financial factor that is associated with the guarantee as well as employee benefits, including salaries, benefits (social security, benefits, facilities, promotion).

Informants also have pride as member of ABC, so they like to give good recommendation of ABC as Christian University; good working place to work. Meaning ABC has motivate the employee well then employee will feel a positive condition and is satisfied that they would be willing to do more than expected performance (Sugandi et al., 2013; Meilani, 2009). Although relation with supervisor (head of department) find in average level, but both informant agree that does not affect completion of the work. Beside that team work is running well because among employee building their relationship naturally. It can be occurred in condition that employee feel happy then they engaged as a team work and has strong relationship to supported each other. There is employee engagement will make employees feel happy and enthusiastic to work in well performance (Handoko, 2010). It can be explained that motivating factors according Herzberg is a profession of teaching itself, the



success achieved, growth opportunities, career advancement and recognition from others. While for more hygiene factors to influence of the environment such as superiors and colleagues work. In this case informants as lecturers getting a boost internally feel motivated, so they pleased with the work that was engaged with profession. Finally all informants wants to be stay and loyal to ABC in the next ten years because they feel happy to do their job and profession.

Proposed Proposition

Some important concepts in this study will be assembled into a proposition . Proposition is a statement that consists of one or more concepts or variables (Sanusi, 2011). Each proposition shows the interrelationship between the two concepts. Propositions are as follows:

Proposition 1: Organizational Support affected to Employee Satisfaction

Perceived organizational support positively reflected in the statement of research informants that they feel satisfied with all facilities; personal relationship with colleagues; compensation; team work that running naturally, while they expressed that they also can accepted values of organization. Both informants feel The work meaningful to glorified God. The meaning is interviewee feel that the job should give to glorified God that match with vision of ABC university: True knowledge, Faith in God, Godly characters. Although the relationship with the supervisor (head of department) is mediocre but it does not affect the execution of the work that still runs through good teamwork. It is related to Robin and Judge (2009); Nusatria and Suharnomo (2011) states that employees who feel that they have the support of the organization will have a sense of meaningfulness in the employees themselves then they feel satisfied.



Figure 1

Proposition 2 : Relationship Within Organization affected to Employee Satisfaction

Social interactions within the organization will help employees at work and outside of work. Both informants stated has strong relationship to supported each other with faculty colleagues, then teamwork is good and although supervisor not involved to encourage among employee has build their relationship naturally. Related to As'ad, 2012, stated there some of the things that cause satisfaction, and one of them is social factors which are factors associated with good social interaction between fellow employees , and their superiors, and employees of different types job.

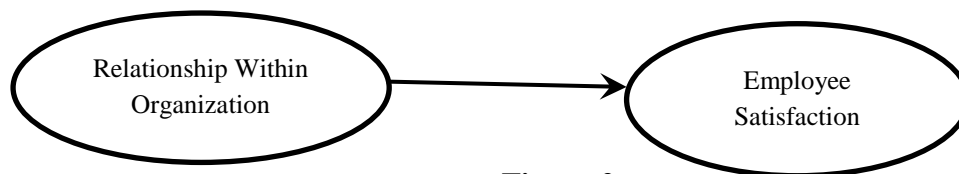

Figure 2

Proposition 3: Employee Satisfaction affected to Employee Engagement

While employee feel satisfied for some factors such as compensation and benefit, job it self, coworker or supervisor, physical atmosphere at work they will have positive feeling about their organization (Sunyoto 2009; Hasibuan, 2007; Sutrisno ,2009). In this study informants feel satisfied by organizational support, relationship within organization. Then as lecturers they feel engaged as cognitive, emotional, attitude to ABC University. Related to David Macleod(engageforsuccess.org, 2016) that stated when employee feeling pride working in an organization they have positive attitude and behavior to improve business outcomes and will offer their capability and potential.



Figure 3

Model Proposed

In this section, propositions that have been formed and then assembled into a theory or model. The model was created by linking a proposition with other propositions. Then the models created in the study are as follows:

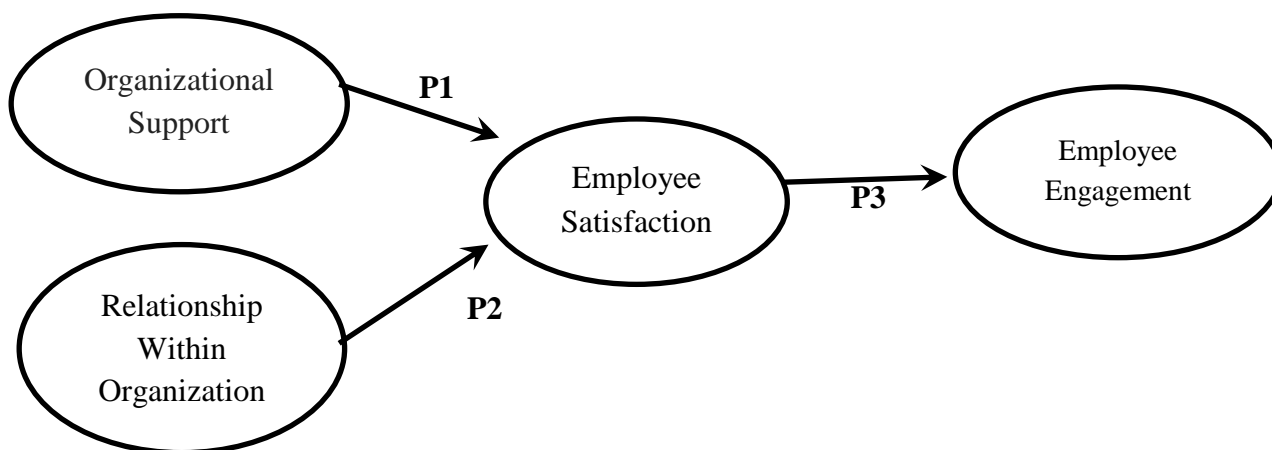

Figure 4

CONCLUSION AND SUGGESTION

Conclusion

As an University ABC need to know how their employees especially lecturer feel engaged with organization. To know engagement feeling based on informants representative of lecturer in ABC University, organization need to support as external motivation of lecturer. ABC University consider are able to provide motivation in the form of organizational support of the employees will make employees feel valued so as to make a positive feeling. Then employees will feel satisfied with the situation encountered in occupational and environmental support as hygiene factors. In term of relationship within organization can affect employee satisfaction because in ABC University there are several communication to make sure that every employees know what is the goal but in this case supervisor roles very important. Managers should already know and understand the characteristics of lecturers. This is very important because the position of lecturers in university (company). Lecturers do not merely as an element of production but also as an

element of an effective corporate investment. Because of the quality of their human resources need to be developed and maintained not only in the context of performance but also job satisfaction. Head of department as direct supervisor of lecturer should give fair, clearly standard of performance then build atmosphere that can encourage teamwork. If employee satisfaction reached indeed, employee will feel more engaged. In this case the employee will be more obedient to the organization with respect to the vision, mission, goals that should which is connected to an organization characterized by several things: (1) understands the vision, mission and objectives of the program as well as the rules of the organization; (2) please and enjoy their work with all responsibilities; (3) high employee motivation; (4) always improve the quality of the performance; (5) is a source of new ideas, innovative; (6) the manager and employees of mutual respect; (7) able to build team work reliably; and (8) to feel as part of a large family of companies.

Suggestion

Managerial implication for ABC University should implementation of the system that inherent value to needs of employees. Meaning ABC University should maintain their lecturers through people management. Especially for direct supervisor should be good leader to enhanced lecturer's performance toward the goal by Tridarma (teaching, research and publication, community service). ABC University should not be too oriented on profit alone, but ignore the needs of lecturers welfare. And do not forget the managerial must always accommodate new ideas from lecturers. Then it is not impossible because lecturers so tightly bound, lecturers will give hard work and produce their best performance in Tridarma.

Research Limitation

In conducting this study, there are limitations, such as: conducted by qualitative method through interviews with limited informants so it should not be generalized to all lecturers; Unable to perform focus group discussion lecturers and head of department because they are not willingness. This study only focus on lecturers perception toward lecturers engagement in ABC University. Then the theoretical suggestions need further research using quantitative methods and conduct empirical testing of the models.



REFERENCES

- Aamodt, Michael G. (2012). *Industrial Organizational Psychology: An Applied Approach*. Cengage Learning.
- As'ad, M. (2012). *Psikologi Industri Seri Sumber Daya Manusia*. Yogyakarta: Liberty.
- Creswell, John W. (2009). *Research Design Qualitative, Quantitative and Mixed Method Approches*. Sage Publication. California.
- Desita, Arta. (2013). Mendikbud: Indonesia Kekurangan Dosen. Access Date: 22-07-2016 <http://infopublik.org/read/63005/mendikbud-indonesia-kekurangan-dosen.html>
- Gibson, J.L., John M. Ivancevich dan James H. Donnelly. (2006). *Organization*. Mc. Graw Hill.
- Hani, Handoko (2010). *Manajemen Personalia & Sumberdaya Manusia*. Edisi kedua. BPFE UGM Yogyakarta
- Hasibuan, M. (2007). *Manajemen Sumber Daya Manusia*, Bumi Aksara, Indonesia Jakarta, pp. 202.
- Ihalauw, John J.O.I. (2008). *Konstruksi Teori, Komponen dan Proses*, Jakarta, Grasindo.
- Lamidi. (2010). Efek Moderasi Kepemimpinan Pada Pengaruh Employee Engagement Terhadap Kepuasan Kerja. *Jurnal Ekonomi dan Kewirausahaan*. Vol. 10, No. 2, Oktober 2010 : 190 – 200. Universitas Petra. Surabaya
- Malhotra, N.K. (2012). *Marketing Research: An Applied Orientation*. 4thEdition. New Jersey: Pearson Education Inc.
- Meilani, Yohana F. Cahya Palupi. (2009). Pengembangan Model Kepuasan Kerja Karyawan PT Impact Indonesia. Volume 4 Nomer 1. Access Date: 14-01-2017. <http://dspace.library.uph.edu//123456789/2125>.
- Nazir, Moch. (2007). *Metode Penelitian*, Ghalia. Jakarta
- Nusatiria, Sandi; Suharnomo (2011). Employee Engagement: Anteseden dan Konsekuensi. Akses 25 Juli 2014 dari _ http://eprints.undip.ac.id/32106/1/Skripsi_3.pdf.
- Pedoman Beban Kerja Dosen. (2010). Akses 22 Juli 2014 dari <http://www.dikti.go.id/id/peraturan-perundangan/pedomanbebankerjadosen>.



- Pentury, Gerrit M. (2010). Kinerja Dipengaruhi oleh Variabel Anteseden dan Dampaknya pada Kepuasan Kerja . *Jurnal Manajemen dan Kewirausahaan*, Volume 12, Nomer 1, Maret 2010:66-75. Universitas Petra. Surabaya.
- Polii, Lidya Ribkha Genta. (2015). Analisis Keterikatan Karyawan Terhadap Pekerjaan dan Lingkungan Kerja Terhadap Kepuasan Kerja dan Turnover Intention Karyawan di RS Siloam Manado. *Jurnal EMBA*. Vol 3 No 4. Desember 2015: 179-190
- Robbins, Stephen P., and Timoty A. Judge. (2013). *Organizational Behavior*. 15 th Edition. New Jersey: Prentice-Hall International Inc. Pg. 128.
- Sanusi, Anwar.(2011). *Metodologi Penelitian Bisnis*. Jakarta: Salemba Empat.
- Sekaran, Uma & Bougie Roger. (2010). *Research Methods for Business, A Skill Building Approach*. USA : John Wiley & Sons.
- Siagian, Sondang P . (2012) . *Manajemen Sumber Daya Manusia*. Jakarta: Bumi Aksara.
- Sugandi, Vannecia Marchelle; Sutanto, Eddy M.; Setiawan, Roy. (2013). Pengaruh Kepuasan Kerja dan Loyalitas Kerja Terhadap Organizational Citizenship Behavior pada Karyawan PT.SuryaTimur Sakti Jatim. *Jurnal Agora*, Volume 1, Nomer 1 Januari 2013. Universitas Petra. Surabaya.
- Sugiyono. (2008). *Metode Penelitian Kuantitatif, Kualitatif dan R&D*. Penerbit Alfabeta. Bandung.
- Sugiyono. (2012). *Memahami Penelitian Kualitatif*. Penerbit Alfabeta. Bandung
- Sunoyo, Danang (2012). *Manajemen Sumber Daya Manusia*. Yogyakarta: CAPS.
- Sutrisno, Edy (2009). *Manajemen Sumber Daya Manusia*. Jakarta: Kencana.
- Undang-Undang Republik Indonesia Nomor 20 tahun 2003. *Sistem Pendidikan Nasional*. Jakarta. CV Eko Jaya.
- Yin, Robert K (2003). *Studi Kasus Desain dan metode*, Jakarta : Raja Grafindo Persada
<http://engageforsuccess.org/what-is-employee-engagement>. Access date: July 30, 2016



**MOTIVES FOR ENGAGING CORPORATE SOCIAL RESPONSIBILITY
PROGRAM**

Gresyelda Lavinia Widjaja

Yie Ke Feliana*

Accounting Study Program, Business and Economics Faculty, University of Surabaya

gres_widjaja@yahoo.com

yiekefeliana@staff.ubaya.ac.id

Abstract

This study aims to determine the motive of company's Corporate Social Responsibility (CSR) activities in relation to the company's financial performance in the future. Motives for conducting and reporting their CSR activities is whether just for charity, investment, or a signaling about the company's financial performance in the future. This research uses quantitative approach in solving the research problem. This study took sample data from companies listed in the Indonesia Stock Exchange during 2012-2014, that were published a stand-alone CSR report or known as Sustainability Report. CSR variable is measured by indexing the Sustainability Report based on the CSR reporting standards issued by the Global Reporting Index (GRI) G4 for environmental and social categories. Firm's future financial performance is measured by changes of the Return on Asset (ROA) in year $t + 1$ and t , changes of Cash Flow from Operations (CFO) in year $t + 1$ and t , and the Average Stock Return (ASR) in year $t + 1$. The samples used in the study are 75 companies. The study's finding that there was no significant relationship between the indexes of CSR with the company's future financial performance. However, this study found that the motive of Indonesia's companies in conducting and reporting CSR activities is only for charitable purposes and the companies do not expect any reward. This is showed by most companies reported social criteria in their sustainability reports more than any other criteria. CSR activities are generally because of the good condition of the previous year company's financial performance. In addition, most companies in Indonesia still perform and report its CSR activities only as compliance with the applicable regulations.



Keywords: *CSR, Company's financial performance, and Sustainability Report*

JEL Classification: *M14*

INTRODUCTION

In this twenty-first century, attention and orientation of companies, especially large companies, are not only for financial profit. Especially, companies in large-interest business commit themselves to conducting business activities that bring economic, social, and environmental benefits to the society (Wang et al., 2015, p. 2232). Sustainable development has the objective to meet the need for humans now without sacrificing the capability of future generations in satisfying their needs, as cited from *National Center for Sustainability Reporting* (NCSR) website. Elkington (1998) in Santis et al. (2016, p. 736) affirmed that the future success key of companies depends on their ability to fulfill not only the traditional bottom line of profitability, but also the bottom lines related to environmental and social issues, Elkington constructed the concept of the Triple Bottom Line (TBL). According to Burritt (2016), sustainability concept is also relevant for modern accountants who care above and beyond money to the fundamentals of what makes the profession a credible force.

Companies' awareness to perform corporate social responsibilities is increasing from time to time. This is shown by the research and survey conducted by KPMG (2013, p. 11). The research shows that there are an increasing numbers of companies in doing the disclosure and reporting of CSR activities. The survey result noted that 93% of 250 world's largest companies (based on Global Fortune 250 Company) have disclosed their corporate social responsibility report. In Pacific Asia, the number of companies that publicize their CSR report is also increasing about 71% in two recent years. Most of the companies report their CSR report based on Global Reporting Initiative (GRI).

Waworuntu, et al. (2014, p. 498) conveys his research finding in International Conference on Accounting Studies 2014, which ASEAN large companies' awareness in voluntary disclosure of CSR report is increasing; even there is a moderate positive correlation between CSR activities and company's financial performance. This indicates that there is awareness of companies to report their business activity concerning with sustainability concept.



In Indonesia, according to the article in NCSR's website on December 10th, 2014, the first company that report their CSR activities was in 2005, then has grown to 60 profit and non-profit companies until 2014.

In conducting CSR activities, companies would expend some additional amount of their resources. Friedman (1970) in Lys et al. (2015, p. 56) suggests that CSR activities are wasting company's resources. Consistent with the study by Aras et al. (2010, p. 244), he finds no causal relation between CSR activities and company's financial performance, good company's financial performance has any impact to enhance CSR performance instead.

In contrast, there is other research finding that company's CSR activities have a correlation with company's performance. This fact is consistent with the research done by Chen and Wang (2011, p. 368) which find that CSR activities leads to improvement of financial performance, even in the next period and vice-versa.

While, research done by Lys et al. (2015, p. 70) explain that positive correlation between CSR activities and company's financial performance as believed by most people, in fact is a signal for future company's financial performance. Only company with strong future financial performance would undertake CSR activities.

Research gap from the prior studies leads people to mislead the company motive in doing CSR activities. Thus, this study aims to examine deeper about the company motive in conducting CSR activities related with company's financial performance. Moreover, this study also examines the direction of the causality between them.

In the literature review and hypothesis development section, the background of the emergence of research hypotheses which are charity, investment, and signals are described. In the research method section, the data and research design also hypothesis testing are described. In the result and discussion section, the findings and discussion of the findings are presented. In the conclusion and recommendation section, the findings and provide suggestions for related future research are concluded.



LITERATURE REVIEW AND HYPOTHESIS DEVELOPMENT

According to Friedman (1970, p. 211), company's ultimate goal is enhancing the shareholders' wealth. If company used the invested money by the shareholders for public interest and CSR activities, that would be a stealing action of shareholders' money.

However, others suggest that company do the CSR activities for ethical reason. Consistent with the stakeholder theory, CSR activities is only a form of corporate responsibility towards the company's stakeholders, because company's stakeholders are important parties to the sustainability of the company. Only companies with excess current resources that will be asked to donate some of their resources as a corporate social responsibility contribution (Campbell, 2007, p. 952; Hong et al., 2012, p. 27).

Furthermore, research conducted by Aras et al. (2008) finds no significant correlation between CSR activities and company's financial performance. This leads to the first hypothesis that CSR activities is just for charity because of the good company's performance (Margolis et al., 2007), which company would not expect any rewards to their future financial performance (Lys et al., 2015, p. 58).

H1: CSR activities have no impact to the future company's financial performance. (Charity Hypothesis)

The concept of "doing well by doing good" encourages companies in doing CSR activities that bring benefit for the society (Lys et al., 2015, p. 58). Some of companies worried whether CSR activities would fail and ineffective. However, the result finding of Chen and Wang (2011, p. 368) research states those CSR activities will not only improve current company's financial performance, but also future company's financial performance.

Company's stakeholders are not only the external parties, but also the internal parties of the companies including the employee. CSR activities that satisfying company's stakeholders will lead to better contribution of the internal stakeholders, such as attract and retain good employee. Meanwhile, in the society, companies will have good image and improved product marketing, not only improving the company's brand image, but also building a better relationship between community and governments.



Besides, consumer will be more attracted to the company and desire to buy company products or services. This will impact to the company sales. Thus, company's financial performance will improve and build a good relationship with their stakeholders. Although companies should expend some additional resources for CSR activities, in the end companies also obtain the benefits.

According to Chen and Wang (2011, p. 368) research findings, CSR expenditures can be one of the company investments which not only bring benefits to current financial performance, but also to the future. Dhaliwal et al. (2011) find that voluntary CSR reporting leads to decreasing cost of capital, higher institutional investor ownership, and broader analyst scope. In addition, Suartana (2010, p. 112) states that corporate social responsibility is not only a management impression tool, but rather a long-term investment that ensures company's profitability and sustainability.

H2: CSR activities have impact to the improvement of future company's financial performance. (Investment Hypothesis)

Several studies about dividends state that dividend tends to change because of the future cash flow, even when there is no intention from the company to issue any information about future company's performance (Miller and Rock, 1985, p. 1037). This reasoning is also followed by Allen and Michaely (2003, p. 386) in their empirical study that cannot distinguish between the options to convey future company's financial performance through CSR activities (active signal) and the implications of CSR activities for the future company's financial performance (passive signal). This leads to the hypothesis that a good future financial performance will convince companies to do CSR activities in the current year.

H3: CSR activities become a signal of the good future company's financial performance (Signaling Hypothesis)

RESEARCH METHOD

This study uses multiple linear regression for the hypothesis testing.



Data

This study collects the CSR activities information from the stand-alone CSR report (Sustainability Report) that is issued in company's official website. CSR activities are measured only from social and environment categories, because those factors do not reflect financial performance or corporate governance. Financial and corporate governance factors do not include, because they are not related with social investments which benefit more in society rather than company's shareholder (Lys et al., 2015, p. 59). The sample of this study is companies listed in Indonesia Stock Exchange (IDX) during 2012 -2014. While, company's financial performance-related information is gathered from annual report of listed companies through web site IDX from 2011 – 2015 due to the research variables which cover t-1 and t+1. Stock price and return of the companies are obtained from Yahoo! Finance through its website (www.finance.yahoo.com).

Sample Selection

Data samples are selected using nonprobability sampling, i.e. purposive judgmental technique. Samples are considered as research object based on the criteria that have been determined by the authors. The criteria are as follow.

- Company presents its financial statement in Rupiah with accounting period starting from January, 1st and ends on December, 31st.
- Company annual financial statement published in www.idx.co.id.
- Company has a stand-alone CSR report (Sustainability Report) separate from the annual report and published through the official website of the company in 2012 – 2014
- All of the information needed is provided in company's financial statement.
- Company does not have negative equity and earning during 2011 – 2015, so this research focus in profit companies, because we assume that profit companies are more likely to do CSR activities.
- Stock prices and returns of the company are available in Yahoo! Finance website through www.finance.yahoo.com.



By these criteria, research samples that are selected are 75 companies from the research population which are 1,448 companies.

Table 1. Data Samples 2012 -2014

Description	Hypothesis 1		Hypothesis 2 and 3	
	Model 2	Model 3 and 4	Model 6	Model 7 and 8
Companies listed in BEI	1,448	1,448	1,448	1,448
Companies do not report stand-alone CSR report	(1,339)	(1,339)	(1,339)	(1,339)
Companies do not earn positive earnings or have positive equity in 3 consecutive years	(11)	(11)	(11)	(11)
Companies do not present their financial statements in Rupiah	(22)	(22)	(22)	(22)
Companies do not present their financial statements in one full year	(1)	(1)	(1)	(1)
Number of companies being researched	75	75	75	75
Outlier companies	(1)	-	(1)	-
Final samples	74	75	74	75

CSR Index

$$CSR_{t,j} = \frac{\sum_{i=1}^j x_{ij}}{n_j} \dots\dots\dots (1)$$

Description:

$CSR_{i,j}$ = CSR index of j company

N_j = number of total criteria that should be reported based on GRI-G4 (82 criteria from social and environmental categories)

X_{ij} = valued 1 if a criteria is reported or valued 0 if a criteria is not reported



Research models used in this research are as follow.

Regression Model 2

$$\Delta ROA_{t+1} = \alpha_{0a} + \alpha_{1a} CSR_t + \alpha_{2a} \Delta ROA_t + \alpha_{3a} ROA_{t-1} + \varepsilon_{1a} \dots \dots \dots (2)$$

Description:

- ΔROA_{t+1} = change between income before extraordinary items measured in the end of year t+1 and year t divided by total assets
- CSR_t = company's CSR index
- ΔROA_t = change between income before extraordinary items measured in the end of year t and year t-1 divided by total assets
- ROA_{t-1} = income before extraordinary items measured in the end of year t-1 divided by total assets

Regression Model 3

$$\Delta CFO_{t+1} = \alpha_{0b} + \alpha_{1b} CSR_t + \alpha_{2b} \Delta CFO_t + \alpha_{3b} CFO_{t-1} + \varepsilon_{1b} \dots \dots \dots (3)$$

Description:

- ΔCFO_{t+1} = change between operating cash flow measured in the end of year t+1 and year t divided by total assets
- CSR_t = company's CSR index
- ΔCFO_t = change between operating cash flow measured in the end of year t and year t-1 divided by total assets
- CFO_{t-1} = operating cash flow measured in the end of year t-1 divided by total assets

Regression Model 4

$$ASR_{t+1} = \alpha_{0c} + \alpha_{1c} CSR_t + \varepsilon_{1c} \dots \dots \dots (4)$$

Description:

- ASR_{t+1} = average stock return for the 12 months beginning on the year t+1
- CSR_t = company's CSR index



Financial performance indicators that are used in this research are Return on Asset (ROA), Operating Cash Flow (CFO) (Lys et al., 2015), and Average Stock Return (ASR). ROA is the most common financial performance indicator. According to Sloan (1996, p. 291), CFO is used as financial performance indicator because it is more persistent and difficult to manipulate. Meanwhile, ASR is used in semi-strong form market; the returns complement the company's financial performance measurement. Charity hypothesis as stated in hypothesis 1 is supported if α_{1a} in model (2), α_{1b} in model (3), α_{1c} in model (4) are equal to zero or negative at level of confidence 5%. On the other hand, if α_{1a} in model (2), α_{1b} in model (3), α_{1c} in model (4) are positive at level of confidence 5%, investment hypothesis as stated in hypothesis 2 or signalling hypothesis as stated in hypothesis 3 are can be supported.

In order to find the optimum CSR activities based on current financial performance, the below regression is done.

$$CSR_t = \beta_0 + \beta_1 ATO + \beta_2 PM + \beta_3 CASH + \beta_4 CFO + \beta_5 LEV + \beta_6 MTB + \beta_7 Size + \beta_8 R\&D + \beta_9 ADV + \beta_{10} LIT + \varepsilon_2 \dots\dots\dots (5)$$

Description:

- CSR_t* = company's CSR index
- ATO* = net sales divided by total assets, measured in the end of year t
- PM* = income before extraordinary items divided by net sales for the year t
- CASH* = cash and cash equivalent divided by total assets, measured in the end of year t
- CFO* = operating cash flow measured in the end of year t divided by total assets
- LEV* = sum of short and long-term obligation divided by total assets, measured in the end of year t
- MTB* = sum of market value of equity, liability, preferred stock liquidation value, deferred taxes, and investment credit divided by total assets, measured in the end of year t
- Size* = natural logarithm of total assets, measured in the end of year t
- R&D* = research and development expense divided by net sales for the year t
- ADV* = advertising expense divided by net sales for the year t
- LIT* = litigation expense divided by net sales for the year t



Regression Model (5) is used to obtain optimal CSR (\widehat{CSR}) and residual CSR ($\widehat{\varepsilon}_2$) value to distinguish between CSR activities for investment or signaling motives. According to Lys et al. (2015, p. 60), CSR expenditures are influenced by company and industry factors. Higher advertising and research and development expenses show higher company's investment in CSR activities. Lys et al. (2015) also include litigation expense as CSR expenditure that act as reputation insurance. The natural logarithm of total assets is used as a measurement for the company size. Company with bigger size tends to have more resources to do more CSR activities. Leverage level and Market to book value are used to show company risk level. Company with lower risk level will be more stable and do more CSR activities. The level of cash and cash equivalent, operating cash flow, and ROA show the company's financial performance.

Regression Model 6

$$\Delta ROA_{t+1} = \gamma_{0a} + \gamma_{1a}\widehat{CSR} + \gamma_{2a}\widehat{\varepsilon}_2 + \gamma_{3a}\Delta ROA_t + \gamma_{4a}ROA_{t-1} + \varepsilon_{3a} \dots\dots\dots (6)$$

Description:

ΔROA_{t+1} = change between income before extraordinary items measured in the end of year t+1 and year t divided by total assets

\widehat{CSR} = optimal CSR

$\widehat{\varepsilon}_2$ = residual CSR

ΔROA_t = change between income before extraordinary items measured in the end of year t and year t-1 divided by total assets

ROA_{t-1} = income before extraordinary items measured in the end of year t-1 divided by total assets

Regression Model 7

$$\Delta CFO_{t+1} = \gamma_{0b} + \gamma_{1b}\widehat{CSR} + \gamma_{2a}\widehat{\varepsilon}_2 + \gamma_{3b}\Delta CFO_t + \gamma_{4b}CFO_{t-1} + \varepsilon_{3b} \dots\dots\dots (7)$$

Description:

ΔCFO_{t+1} = change between operating cash flow measured in the end of year t+1 and year t divided by total assets

\widehat{CSR} = optimal CSR



$\hat{\varepsilon}_2$ = residual CSR

ΔCFO_t = change between operating cash flow measured in the end of year t and year t-1 divided by total assets

CFO_{t-1} = operating cash flow measured in the end of year t-1 divided by total assets

Regression Model 8

$$ASR_{t+1} = \gamma_{0c} + \gamma_{1c}\widehat{CSR} + \gamma_{2c}\hat{\varepsilon}_2 + \varepsilon_{3c} \dots \dots \dots (8)$$

Description:

ASR_{t+1} = average stock return for the 12 months beginning on the year t+1

\widehat{CSR} = optimal CSR

$\hat{\varepsilon}_2$ = residual CSR

Signalling hypothesis as stated in hypothesis 3 is supported if γ_{2a} in model (6), γ_{2b} in model (7), γ_{2c} in model (8) are not equal to zero at level of confidence 5%. On the other hand, investment hypothesis as stated in hypothesis 2 is supported if γ_{1a} in model (6), γ_{1b} in model (7), γ_{1c} in model (8) are not equal to zero at level of confidence 5%.

All regression models are tested with four classic assumption tests except regression model 5, because it is only used to obtain \widehat{CSR} and $\hat{\varepsilon}_2$ variable value from the multiple linear regression result. After classic assumption test, hypothesis testing is continued by multiple linear regression analysis, consists of determination coefficient, F-test, and t-test. In this research, hypothesis testing uses Microsoft Excel 2010 and PASW Statistic 18 (SPSS 18) software. For determining whether the research hypothesis is accepted or rejected, it is based on the result of multiple linear regression especially t-test.

RESULT AND DISCUSSION

The results in Table 2 show that independent variable which is the main focus of hypothesis 1, CSR_t , has no significant relationship to the dependent variable in all regression model used in hypothesis 1. The dependent variables stand for company's financial performance as measured by ΔROA_{t+1} , ΔCFO_{t+1} , and ASR_{t+1} . However, there are several control variables that have negative significant relationship to the dependent variables which



are ROA_{t-1} has significant relationship to ΔROA_{t+1} with 0.025 significance value in regression model 2 and ΔCFO_t and CFO_{t-1} have significant relationship to ΔCFO_{t+1} with 0 significance value in regression model 3. Based on the result of hypothesis testing, it can be concluded that hypothesis 1 is accepted.

Table 2. Result for H1, H2, and H3

Regression Model	Independent Variables	Coefficient	Sig.
Model 2	<i>Constant</i>	0	0.985
	CSR_t	-0.014	0.173
	ΔROA_t	-0.076	0.517
	ROA_{t-1}	-0.06	0.025*
Model 3	<i>Constant</i>	0.02	0.151
	CSR_t	0.006	0.857
	ΔCFO_t	-0.372	0*
	CFO_{t-1}	-0.221	0*
Model 4	<i>Constant</i>	0.006	0.423
	CSR_t	-0.008	0.566

*: Significance < 0.05

Table 3. Result for H2 and H3

Regression Model	Independent Variables	Coefficient	Sig.
Model 6	<i>Constant</i>	0.006	0.417
	\widehat{CSR}	-0.032	0.128
	$\widehat{\varepsilon}_2$	-0.009	0.404
	ΔROA_t	-0.074	0.528
	ROA_{t-1}	-0.043	0.162
Model 7	<i>Constant</i>	0.061	0.016*
	\widehat{CSR}	-0.108	0.099
	$\widehat{\varepsilon}_2$	0.037	0.285
	ΔCFO_t	-0.288	0.006*
	CFO_{t-1}	-0.138	0.055
Model 8	<i>Constant</i>	-0.001	0.963
	\widehat{CSR}	0.006	0.808
	$\widehat{\varepsilon}_2$	-0.016	0.387

*: Significance < 0.05

The results in Table 3 show that independent variables which are the main focus of hypothesis 2 and 3, \widehat{CSR} and $\widehat{\varepsilon}_2$, have no significant relationship to the dependent variable in all regression model used in hypothesis 2 and 3. The dependent variables stand for company's financial performance as measured by ΔROA_{t+1} , ΔCFO_{t+1} , and ASR_{t+1} . This also supports the result findings in hypothesis 1 testing. However, there is a control variable which is ΔCFO_t that has negative significant relationship to the dependent variable, ΔCFO_{t+1} , with 0.006 significance value in regression model 7. Based on the result of hypothesis testing, it can be concluded that hypothesis 2 and 3 are rejected.

From Pearson correlation testing for CSR_t variable, greater asset turnover, cash, operating cash flow, and market-to-book value lead to greater CSR index of the company. This indicates that company tends to do more CSR activities if it has good financial condition.



Furthermore, CSR aspect that we examined is only environmental and social categories. In Figure 1, it is shown that companies report more social criteria than environmental criteria, i.e. 54% from all of the reported criteria. This suggest that CSR activities doing by companies are intended for social purposes and do not expect any incentives for the companies. Thus, it supports the charity hypothesis.

Proportion of Environment and Social-under GRI G4

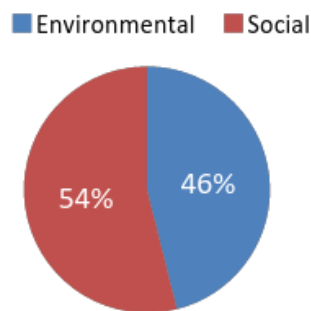

Figure 1

In Figure 2, we show each category more specifically into subcategories. It is shown that Labor (LA) subcategory about labor practices and decent work is the most subcategory that has been reported. This subcategory has several aspects including employment, labor/management relations, occupational health and safety, training and education, diversity and equal opportunity, equal remuneration for women and men, supplier assessment for labor practices, and labor practices grievance mechanisms (GRI, 2013). Thus, CSR activities reported by companies are more oriented towards internal data which are more easily obtained because they are directly related to the employee. Then, the next most reported subcategory is Product Responsibility (PR). This subcategory addresses the customer health and safety, product and service labeling, marketing communications, customer privacy, and compliance. This also denotes that companies reported more CSR activities based on internal data which is more easily obtained.

Reported GRI G4 Criteria Proportion

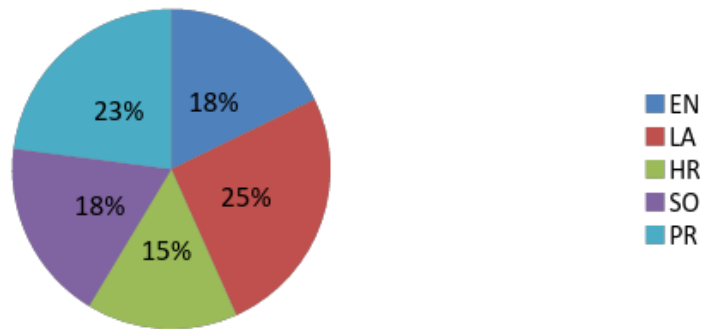

Figure 2

In addition, in Figure 3, the reported and unreported criteria from each subcategory are shown. It is noted that LA subcategory is the most reported criteria by 53% reported of all aspects that should be reported related to labor practices and decent work. In contrast, Human Rights (HR) subcategory is the least reported criteria that are only 32% of the total aspects that should be reported.

Reported GRI G4 Criteria

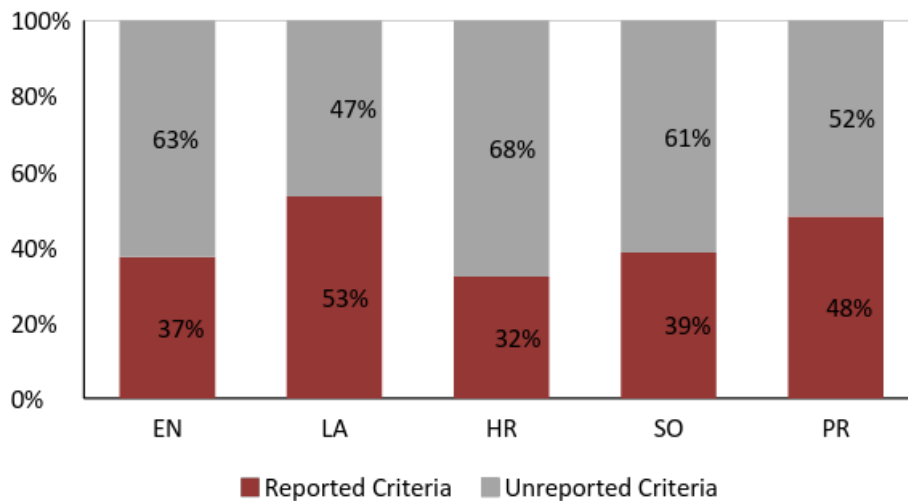

Figure 3

In Indonesia, reporting CSR activities is regulated in *UU No. 40 2007 about Corporation* article 66, which states every company shall submit the Annual Report



containing the implementation of Corporate Social Responsibility report. Also, article 74 is specifically regulated about Corporate Social Responsibility. Indonesia government also commits its concern about Corporate Social Responsibility (CSR) by issuing *Government Regulation (PP) RI No. 47 2012 about Social and Environment Responsibilities*. Most companies report their CSR activities only to meet its obligations under the applicable regulations which are limited in Annual Report. This fact also explains why only small numbers of listed companies in BEI disclose their CSR activities in stand-alone report called Sustainability Report.

This research finding is consistent to the research findings of Aras et al. (2008) that investigate the relationship between CSR and company's financial performance in listed companies in Istanbul Stock Exchange (ISE) 100 during 2005 to 2007. Measurement is based on company size, profitability, risk level, and CSR. Aras et al. (2008) finds that there is no significant correlation between CSR and company's financial performance in emerging countries. However, there is a relation between company size and CSR. Aras et al. (2008) also argue that the absence of this relationship is not due to the characteristics of emerging countries rather because CSR activities are still broad and many researches are still conducted in this topic. Thus, it is not surprising that there are some research findings are contradictory.

Apparently, research conducted by Aras et al. (2008) has similarity with this research which is also using companies in emerging country and has a limited number of samples, since not all of the companies reported their CSR activities. Moreover, reporting CSR activities in a stand-alone report called Sustainability Report is costly, even there is a separate audit for the report. Thus, there is a possibility that CSR activities' reporting has not become a major concern for companies that would affect their financial performance in emerging country.

A similar result is also found by Santis et al. (2016, p. 743) who do a research about the effect of CSR on company's financial performance that is listed on the Sao Paulo Stock Exchange Index during 2009 to 2013. Santis et al. (2016) find that more sustainable companies (having ability to generate profits, as well as concerning the environment and social) have no better financial performance. This fact suggests that there is no incentive generated for companies to adopt better sustainability strategies.



This research finding is not consistent with research conducted by Chen and Wang in 2011. Chen and Wang conduct a research to investigate the two-way relationship between CSR activities done by companies in Guangdong, China during 2007 – 2008 and the financial performance in the current or next period. The research is based on the theory that from strategic perspective, CSR activities can attract stakeholders' interest. Chen and Wang convey that CSR activities have a good impact to the company both in the current and even in the following period. In their arguments, they explain that this happens because the internal stakeholders are aware that CSR activities will bring positive effect for the parties around the companies. Thus, they would dedicate more to contribute in the community, so that the external stakeholders will also be interested to the company and the company has managed positive image in the community as well. This will bring good impact to the company's financial performance both in the current or following period.

This research finding is also not consistent with the research done by Lys et al. in 2015. Lys et al. (2015) conduct a research about CSR activities of companies listed in Russel 1000 during 2002 – 2010. In their research, they find that CSR reporting can be a signal for external parties which indicates a good financial future performance; although they do not distinguish the signal is active or passive. Financial performance measured by ΔROA_{t+1} and ΔCFO_{t+1} , while for ASR_{t+1} , Lys et al. (2015) also do not find any significant correlation between CSR activities and future stock return. These research findings are also relevant to the existence of some regulations for content and credibility of the company's accountability reporting. Meanwhile, there is still no regulation that requires companies in Indonesia to have a sustainability report to disclose CSR activities separately.

Regarding to stakeholder theory, CSR activities are only as a form of their social responsibility to stakeholders both internal and external which is needed to support company's sustainability. Although, these CSR activities are in contrast with the management's desires to maximize the profit because they have to set aside some funds for these.

Pearson correlation test is also performed and there is an indication that Indonesian companies have a weak prediction of their future financial performance through reported CSR activities. However, they tend to do more CSR activities if they have experienced a



good financial condition in the prior period, so that CSR activities are more as a form of feedback rather than a predictive tool for the company. It is shown from significant negative correlation between the change of ROA $t+1$ and t with CSR index, as well as a significant positive correlation between ROA $t-1$ and CSR index. This fact is also confirmed with significant negative correlation between CSR index and change of CFO t and $t-1$. This means that if companies do more CSR activities, the change between CFO in year t will be smaller. Furthermore, a positive correlation between CFO_{t-1} and CSR_t shows that when a company has a greater operating cash flow in prior year, the company tend to do more CSR activities in year t .

CONCLUSION AND RECOMMENDATION

Based on the research and analysis of the hypothesis testing, statistical test results show that CSR_t , the main focus of research, has no significant correlation with the dependent variable in all regression models. The dependent variables in this research stand for company's future financial performance. This proves that the Charity Hypothesis is accepted, whereas the Investment Hypothesis and Signaling Hypothesis is rejected. Adjusted R^2 value that describes the ability of the independent variables and the other factors affect the dependent variable are also considered low. From the Pearson test of CSR_t variable, CSR index has positive correlation with asset turnover, cash, operating cash flow, and market-to-book value.

CSR activities being researched only include environmental and social categories. Social criteria are reported more than the environmental criteria which is 54% that is shows that CSR activities is intended for social activities and do not expect any rewards for companies.

In Indonesia, which is also an emerging country, CSR reporting has not become a major concern for companies that would affect the financial performance and is only for regulations compliance. There is a weak tendency that companies undertake more CSR activities if they have experienced a good financial condition in prior year (measured by ROA and CFO $t-1$), so it is more as form of feedback. Thus, we concluded that the CSR activities



do not have significant correlation to the company's future financial performance and more likely due to charitable purposes (Charity Hypothesis).

Further research is expected to use another CSR activities measurement (other than content analysis), so that the number of samples will be greater and avoid too much biases. This will describe more real situation. The future research should cover a longer period of time, so that able to capture company motives indication in doing CSR activities more accurately. Further research can measure company's future financial performance using another proxy, besides ΔROA_{t+1} , ΔCFO_{t+1} , and ASR_{t+1} , and considering the industry condition, so that will improve the existed research.

REFERENCES

- Allen, F. and Michaely, R., (2003), Payout Policy, *Handbook of the Economics of Finance*, Elsevier.
- Aras, G. et al., (2010), "Managing corporate performance, Investigating the relationship between corporate social responsibility and financial performance in emerging markets", *International Journal of Productivity and Performance Management*, Vol. 59, pp. 229-254.
- Burritt, R., (2016), *Value of external assurance for sustainability reporting*, <https://rogerburritt.wordpress.com/category/sustainability/> (accessed October 25th, 2016).
- Campbell, J. L., (2007), "Why would corporations behave in socially responsible ways? An institutional theory of corporate social responsibility", *Academy of Management Review*, Vol 32, pp. 946-967.
- Chen, H. and Wang, X., (2011), "Corporate social responsibility and corporate financial performance in China: an empirical research from Chinese firms", *Corporate Governance: The international journal of business in society*, Vol. 11, pp. 361-370.
- Ferrell, O. C. and Geoffrey, H., (2000), *Business: A Changing World*, McGraw-Hill, New York.
- Freeman, R. E. et al., (2010), *Stakeholder Theory: The State of The Art*, Cambridge University Press, Cambridge.



- Gitman, L. J. and Zutter, C.J., (2015), *Principles of Managerial Finance* (14th Ed.), Pearson, London.
- Global Reporting Initiative, (2013), *G4: Pedoman Pelaporan Keberlanjutan, Prinsip – Prinsip Pelaporan dan Pengungkapan Standar*, Amsterdam.
- Gujarati, D. N., (2003), *Basic Econometrics* (4th Ed.), McGraw-Hill, New York.
- Hansen, D. R. and Mowen, M. M., (2007), *Managerial Accounting* (8th Ed.), Thomson Higher Education, USA.
- Hong, H., Kubik, J.D., and Scheinkmanx, J.A., (2012), “Financial Constraints on Corporate Goodness”, *Working Paper*, Princeton University, New Jersey.
- Kotler, P. and Lee, N., (2004), *Corporate social Responsibility: Doing the Most Good for Your Company and Your Cause*, John Wiley & Sons, Inc, New Jersey.
- KPMG, (2013), *The KPMG Survey of Corporate Responsibility Reporting 2013*, KPMG International Cooperative (“KPMG International”).
- Lussier, R. N., (2000), *Management fundamental*, Thomson Learning, Inc., New York.
- Lys, T., Naughton, J.P., and Wang, C., (2015), “Signaling through corporate accountability reporting”, *Journal of Accounting and Economics*, Vol. 60, pp. 56-72.
- Margolis, J. D., Elfenbein, H.A., and Walsh, J.P., (2007), Does it pay to be good?: a meta-analysis and redirection of research on the relationship between corporate social and financial performance, *Working Paper*, Harvard University.
- Miller, M. H. and Rock, K., (1985), “Dividend Policy under Asymmetric Information”, *The Journal of Finance*, Vol. 40, pp. 1031-1051.
- NCSR, (2016), *About NCSR*, <http://ncsr-id.org/about-ncsr/> (accessed October 17th, 2016).
- Nugroho, B. A., (2005), *Strategi Jitu Memilih Metode Statistik Penelitian dengan SPSS*, C.V. Andi Offset, Yogyakarta.
- Priyatno, D., (2009), *SPSS untuk Analisis Korelasi, Regresi, dan Multivariate*, Penerbit Gava Media, Yogyakarta.
- Samalanga, D., (2014), *Sustainability Reporting Award (SRA) 2014*, <http://sra.ncsr-id.org/sustainability-reporting-award-sra-2014/> (accessed November 12th, 2015).
- Santis, P., Albuquerque A., and Lizarelli, F., (2016), “Do sustainable companies have a better financial performance?”, *Journal of Cleaner Production*, Vol 133, pp. 735-745.



- Scott, W. R., (2015), *Financial Accounting Theory* (7th Ed.), Pearson, Toronto.
- Sloan, R. G., (1996), “Do stock prices fully reflect information in accruals and cash flows about future earnings?”, *The Accounting Review*, Vol 71, pp. 289-315.
- Suartana, I W., (2010), “Akuntansi Lingkungan dan *Triple Bottom Line Accounting*: Paradigma baru akuntansi bernilai tambah”, *Jurnal Bumi Lestari*, Vol. 10, pp. 105-112.
- Supranto, J., (1995), *Ekonometrik* (Buku Dua), Lembaga Penerbit Fakultas Ekonomi Universitas Indonesia, Jakarta.
- Wang, D. H. et al., (2015), “The effects of corporate social responsibility on brand equity and firm performance”, *Journal of Business Research*, Vol. 68, pp. 2232-2236.
- Waworuntu, S. R., Wantah M.D., and Rusmanto, T., (2014), “CSR and financial performance analysis: evidence from top ASEAN listed companies”, *Procedia-Social and Behavioral Sciences*, Vol 164, pp. 493-500.



**THE INFLUENCE OF LEADERSHIP STYLE AND ORGANIZATIONAL CULTURE
IN THE IMPLEMENTATION OF RISK MANAGEMENT**

Asty Khairi Inayah

Student Master in Science in Strategic Management
Faculty of Economics and Business
Universitas Indonesia

Tengku Ezni Balqiah

Senior lecturer
Faculty of Economics and Business
Universitas Indonesia

Abstract

The impact of the global financial crisis has highlighted the importance of risk management. The role of risk management was also associated with changes in the business environment. The strategy process is divided into two steps, namely the formulation and implementation. Risk management carried out in the strategy formulation process as a project to identify opportunities and risks in accordance with the company's strategy. Implementation of Enterprise Risk Management (ERM), which can effectively help the organization achieve its goals, and lead to the creation of value for the organization. Risk management is an activity which integrates recognition of risk, risk assessment, developing strategies to manage and mitigate risk using managerial resources. From previous research, organizational culture is identified as an important key in contextual factors for the success of the company's risk management. Identifying the individual leader's style is central to evaluating the quality of leadership and effectiveness, especially for organizational goals and manage the risk in the company. The purpose of this study is to propose a conceptual framework of leadership styles, organizational culture and risk management. This study will be discussed at one of the state-owned insurance company with quantitative methods conducted through a survey of middle management and employees. The results of this study will contribute to the company



to determine the influence of leadership style and organizational culture adopted by the company for the implementation of risk management.

Keyword: *leadership style, organizational culture, risk management.*

JEL Classifications: *M14, D80*

INTRODUCTION

The impact of the global financial crisis has highlighted the importance of risk management. Risk management is a systematic approach that develops a strategy, people, technology, processes and knowledge that has the objective to assess, evaluate and manage the risks faced by the organization. In particular, risk management is done in the process of strategy formulation as a project to identify opportunities and risks in accordance with the company's corporate strategy (Mintzberg, 2003). Most of the risk management approach is still evolving (Kaplan and Mikes, 2014). Enterprise Risk Management (ERM) is a systematic approach to risk management across the enterprise to identify, assess, respond and report on opportunities and threats affecting the company in achieving its goals. In Indonesia, the implementation of risk management in insurance companies must comply with the Financial Services Authority Regulation No. 1 / POJK.05 / 2015.

The quality of leader in making a decision can determine the effectiveness of risk management in the enterprise (Lowell, 2015). An effective leader knows how to improve employee motivation and make employees loyal to the organization (Alkahtani, 2015). Employee empowerment is largely dependent on management's ability to demonstrate leadership style that promotes the participation and the creation of a safe environment, where employees feel comfortable in expression (Huang *et al.*, 2010; Mantere and Vaara, 2008; Moeller, 2007). In addition, organizational culture is also one of the contextual factors that have an important role for the success of management in the organization in addition to leadership (Koompai, 2010). However, research on organizational culture and ERM are still very limited (Thomya and Saenchaiyahon, 2015). Making the culture of the organization became a significant factor in the implementation of ERM (Kimbrough and Componation, 2009). Therefore, the main issue in this study is whether an organization characteristic such



as leadership style and organizational culture may affect the implementation of risk management in one of the insurance companies in Indonesia.

The paper begins with a brief overview of the literature on leadership styles, organizational culture, and implementation of risk management. Followed by the discussion of the methodology used in this study and the presentation of the analysis and the results of the research of the submitted questionnaire that correlates the relationship between the two organizational characteristics of leadership style and organizational culture to the application of risk management. Thereafter, there are results suggesting that the relationship between leadership styles and the application of risk management is reinforced by organizational culture. At the end of this paper, the research conclusions are highlighted.

LITERATURE REVIEW

Leadership Style

Leadership is complex and influenced by a wide range of relationships, situations, personalities, and well as additional factors in its field of endeavor (DeCaro, 2005). Leadership is often defined as the process of direct and influence a group of people in an organization. Effective leadership is the leader who succeeded in implementing changes in the organization, especially during critical periods and unexpected changes in the external environment (Littrell and Nicolae Valentin, 2005). The influence of a leadership can lead to improved performance of the company can be viewed directly on the decisions taken and the actions taken by the leader (Cetin, 2012).

Organizational Culture

Culture is considered as the soft side of an organization (Smith, *et al.* 1993; Alvesson 2002). Culture is one of the most powerful influence on decision-making for an organization as well as in determining strategy (Schein, 2010). Organizational culture is the most effective factor in knowledge management and learning within the organization, but also can become a bottleneck in the transfer of knowledge (Rahgozar *et al.*, 2012). Based on the previous



description, organizational culture tends then affect both the business processes and decision-making, affecting both the perception and behavior of employees.

Implementation of Risk Management

Every activity in the company will inevitably face a variety of risks that may affect the achievement of corporate goals. Risks may hinder the achievement of corporate objectives (Djohanputro, 2013). Environmental changes that occur making the company uses proactive risk management techniques, namely the Enterprise Risk Management (ERM), which has become a major resource in developing a risk management system (Choi *et al.*, 2015; Kaplan and Mikes, 2014; Power, 2009). Definition of Enterprise Risk Management (ERM) by COSO (2004) is a process, influenced by the board of the entity of directors, management and other personnel, applied in setting strategy and across the enterprise, designed to identify potential events that may affect the entity, and manage risk are in risk appetite, to provide reasonable assurance of achieving the entity's objectives. ERM talk about integration in three ways. First, ERM requires an integrated risk structure of the organization. Second, ERM requires the integration of strategy in the aspect of risk transfer. Third, ERM requires the integration of risk management for the company's business processes. Compared with the pattern of the defensive approach or control-oriented in addressing the lower limit of risk and earnings volatility, ERM optimize business performance by supporting and influencing the price, resource allocation, and other business decisions. To summarize, ERM is a process associated with strategy and operations at all levels with the cooperation of all individuals throughout the organization, to identify and manage the uncertain events that may affect the organization, to guarantee sufficient to achieve organizational goals.

METHODOLOGY

Research Model

Based on the literature review, the theoretical framework to determine the influence of characteristics of organization in the implementation of risk management as follows



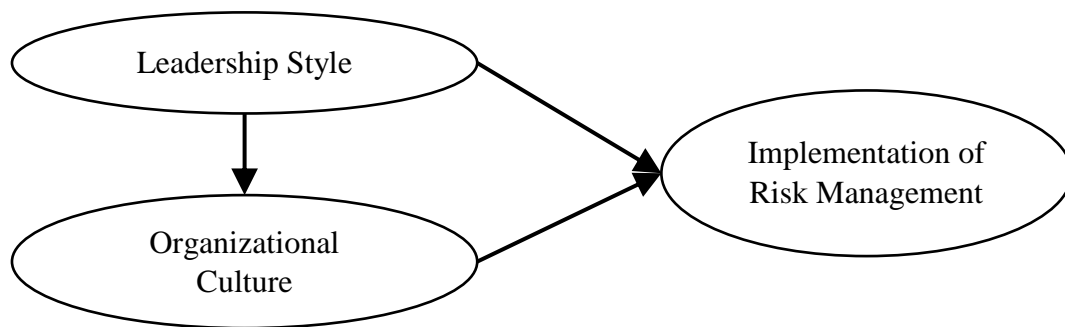

Figure 1. Theoretical Framework of the Study

Research Hypothesis

Leadership Style and Implementation of Risk Management

Research Campbell (2013) states that the effectiveness of risk management national government is largely driven by two factors latent variables that good leadership and governance. The process of risk management, can be a sign of leadership character by showing prudence, wisdom, integrity, honesty, and even the courage to recognize and take actions that have a high level of risk, namely the uncertainty. In the planning and development of strategies, the role of leader is very important (Yukl 2006; Praat, 2004). Strategy formulation is an important aspect in the effective management, this is because the right strategy will provide superior performance results. Effectiveness of risk management seen from the characteristics of leadership that is careful, thoughtful, integrity, honesty and the courage to recognize and take action on risks and uncertainties. This can help in shaping the characteristics of leadership, (Kane and Patapan, 2010).

Based on research conducted by previous researchers, this study will put forward a hypothesis that reflects a causal relationship as follows

H1: Leadership Style has a positive effect on the implementation of risk management.

Organizational Culture and Implementation of Risk Management

Overall, the literature on organizational culture is rich and diverse. Culture in each organization will influence decision-making within the company, including the investment

decisions that have risks and fraught with uncertainty (House *et al.*, 2004). The Company has a risk culture proves that the employees at the company to understand the orientation of the strategy and risk appetite in accordance with the applicable firms (Farrell and Hoon, 2009). Changes in risk perception and strategy is a dynamic process. Strong leadership, commitment and involvement of all elements of the organization can transform the way organizations behave and make decisions (Perrin, 2009). The ability of risk management practices in an organization depends on the extent to which it is embedded in the organizational culture and management decision-making (Cooper *et al.*, 2013).

Based on research conducted by previous researchers, this study will put forward a hypothesis that reflects a causal relationship as follows

H2: Organizational culture has a positive effect on the implementation of risk management.

Leadership Style and Organizational Culture

The influence of leadership on organizational culture showed a leader who can make a big change in culture, already has a different culture (Schein, 2010). An important component in the implementation of risk management is the leadership needed to create a culture of risk awareness, not in the application of strategic risk management of individual (mitigation plans, hedging, adapt, avoid, and so forth), but to provide transparency, communications and essential support consistent to create a culture of risk (Levy *et al.*, 2011).

Based on research conducted by previous researchers, this study will put forward a hypothesis that reflects a causal relationship as follows

H3: Leadership Style and Organizational Culture has a positive influence on the implementation of risk management.

Sample and Data Collection

The sample was drawn from participants who are currently working on insurance company which is the object of this study in Indonesia. The sampling technique employed is convenience based non-probability sampling. Subjects were asked to seal the completed



questionnaire in the envelopes provided and deposit them to the human resources division. The respondents were assured of confidentiality and anonymity.

Instrument

The primary tool used for data collection was questionnaires. The questionnaire has four sections. Section 1 consists of basic demographic data, including sex, age, the number of years in their present position and educational qualification.

Section 2 is the leadership style measurement. House (1971a) and House and Dessler (1974) measure of leadership style, which in turn was principally based on the earlier work of Fleishman (1957) and Stogdill (1963), was presented as reliable and valid by a number of respected authors and texts (for example, Teas, 1981; Kohli, 1989). This study will use the item the question of research Ogbonna and Harris (2000), which uses 12 questions on the three-dimensional items that participative leadership style, supportive leadership style and instrumental leadership style. A participative leader who provides an opportunity to subordinates to be involved in decision-making and provide ideas and recommendations for improving corporate performance. Supportive is the leader who can show sympathy, friendly and attentive to subordinates in circumstances that require the support of a leader who can provide motivation when in saturation jobs. While the instrumental is a leader who decisive procedures, objectives, and allocating tasks in accordance with the proportions. Subjects indicate their level of valuation with each of these aspects by responding on a five-points rating scale ranging from “strongly agree” (1) to “strongly disagree” (5).

Section 3 is the organizational culture measurement. The principal components analysis of measures of organizational culture adopted from the work of Deshpande *et al.* (1993), Campbell and Freeman (1991) and Quinn (1988). Based on the adjustments to the research to be conducted Organizational Culture Assessment Instrument (OCAI) consists of 24 items of questions with four typologies of organizational culture that clan, adhocracy, bureaucratic and market. In the clan culture, the working environment is open and friendly to enable more people to interact and share. Adhocracy culture focus on the external organization and differentiation that can survive, compete, and grow sustainably in creating creativity and innovation in taking risks. Bureaucratic culture prioritizes stability and control



as well as a focus on internal processes and integration. Market culture focused on working relationships and transactions. Subjects indicate their level of valuation with each of these aspects by responding on a five-point rating scale ranging from “strongly agree” (1) to “strongly disagree” (5).

Section 4 is the application of risk management measures. The lack of an ERM measurement instrument that meets these research criteria clearly, new instruments are developed. The questions are generally supported by the literature, reflecting the ERM components of other instruments. The instruments in this study are tailored to the application of risk management in Indonesia. Implementation of risk management in accordance with the regulation of the financial services authority number 1 / POJK.05 / 2015 on the implementation of risk management for non-bank financial services institutions. A key subset of questions based on five components of the financial services authority rules, namely the Internal Environment; objective setting; event identification, risk assessment, risk response, and control activities; information and communication; and monitoring. This measurement uses 20 items of questions. Subjects showed valuation levels with each of these aspects to respond to the five-point rating scale ranging from “strongly agree” (1) to “strongly disagree” (5).

Data Analyst

Following calculation of descriptive indexes of research variables, structural equations model was used for investigating causal relationships between variables. The hypotheses were tested in a structural equation model using SEM software in a two-stage procedure. The first stage involved estimation of the measurement model using confirmatory factor analysis to determine convergent and discriminant validity. The second stage compared the theoretical model with the measurement model. Based on the results of the test, the structural model was used to provide path coefficients for testing the different hypotheses. The equation is formulated to express the causality relationship with the various constructs forming a model of exogenous and endogenous latent construct measurement.

In the structural equation model, the indicator variable is used to form the latent construct. In this study, exogenous constructs are independent variables of leadership style,



while endogenous constructs include organizational culture and application of risk management. The parameters that describe the regression relationship between latent constructs are generally written in Latin characters, namely "Beta" (β) for exogenous construct regression to endogenous and "Gamma" (γ) constructs for latent variable constructs to their dimensions. While "Lambda" (λ) to show the value of the relationship between the dimension and its indicator. Additional fit measures, such as the Goodness of Fit Index (GFI) and the Root Mean Square Error of Approximation (RMSEA), were calculated to test the model fit (Gerbing and Anderson, 1992).

RESULT

All correlations between items representing different latent variables are well below 0.6, indicating no multicollinearity problems. In the factor analysis must meet the adequacy of the number of observations (data) for factor analysis with Kaiser Meyer Oikin (KMO) values greater than 0.5. Furthermore, to see the correlation value between multivariate variables, see the output on Anti Image Matrices where here we need to see the side of Measure of Sampling Adequacy (MSA) only that there is a letter "a" it on Anti Image Correlation. Experts suggest that the value of this MSA always ranged from 0 to 1. The χ^2 test of the measurement model was significant. Thus, relying on multiple fit indices rather than on the χ^2 test alone is recommended, and we proceeded to inspect a number of comparative GFIs that measure the proportional improvement of the model fit by comparing the hypothesized model with a restricted baseline model. The fit of the models was tested using the RMSEA and the global comparative fit index (CFI) in addition to the normed fit index (NFI) and the Tucker-Lewis index (TLI) (Hult *et al.*, 2006; Gerbing and Anderson, 1992). SEM does not test for causality and the direction of the effect, the assessed models must be based on theory.

A leadership style that has considerable influence in the current application of risk management is instrumental leadership rather than participative leadership and supportive leadership. This is seen from the value of gamma that is instrumental leadership has value 0.92 whereas participative leadership is 0.67 and supportive leadership is 0.71. In the application of risk management for the risk identification process, good communication from



a leader is required to explore the potential risk information of each process performed by the work unit. The type of organizational culture has a major impact on the implementation of risk management. Cultural clan has a great influence compared to the culture of adhocracy, bureaucratic culture and market culture. This can be seen from the value of gamma cultural clan of 0.97, higher than the other three organizational cultures. Variable culture is considered a critical variable for effective strategy making and influencing the various phases of the strategic decision process and consequently influencing the content of corporate strategies. The influence of a good leadership style if it is not supported by appropriate organizational culture will affect the effectiveness of risk management implementation. This is seen from the dominant beta value of leadership style of 0.60 and organizational culture of 0.55.

The CFI consideration sample size and values of 0.90 or better indicate a model with a good fit. The RMSEA is sensitive to the number of estimated parameters in the model, as it considers the error of approximation in the population; values below 0.08 indicate a good fit. The fit characteristics of the measurement model for direct effect of leadership style and organizational culture (NFI=0.92; TLI=0.95; CFI=0.94; RMSEA=0.01). While a focus on ERM presumably has a positive effect on a company's risk performance, Senge (1990) and Moeller (2007) have stressed the need for creating a culture of risk management at all levels in the organization (Senge, 1990, p. 4). The model that using organizational culture as moderating variable as suggested in *H3* the fit of model (NFI=0.94; TLI=0.92; CFI=0.94; RMSEA=0.04).

DISCUSSION

Hypothesis testing was done by looking at the critical value (CR) at the rate of 95% or 5% error, then the value of CR received is equal to 1 (Hair *et al.*, 2006). The results of hypothesis testing the effect of leadership style on implementation of risk management, organizational culture towards the implementation of risk management and leadership style on the organizational culture of risk management in this study was obtained based on the t-values data processing.



Influence leadership style to the application of risk management gain CR value of $3.21 > 1.96$, which means the first hypothesis which predicts relationship between leadership style and implementation of risk management is significant. Every leader has to make decisions, and such decisions affect the fortunes of every member of the group or the organization depending on the scale and context of the decision. Therefore, a leader is a risk taker. How well a leader assesses the risks involved and how well the decisions adopt the risk levels to execution will determine the payoffs of every member of the group and the effectiveness of the leader. The risks associated with the leadership decision is bound to generate criticism from subordinates as it may be deviating from their interests or what needed to be done in their perceptions.

The influence of organizational culture on the implementation of risk management gain CR value of $2.45 > 1.96$, which means the second hypothesis which predicts relationship between organizational culture and implementation of risk management is significant. As evidenced by the practitioner literature, risk is effectively embedded within organization processes and used in day-to-day decision making when a risk culture is established within an organization (Towers Perrin, 2009). Decisions of management and employees are influenced by risk culture, even when they do not consciously weigh risks and benefits (Farrell and Hoon, 2009). Without a strong risk culture, even a strong ERM program may not influence decision making; thus, it may be considered an important building block of effective risk management (Farrell & Hoon, 2009). If an organizational culture is a complex group learning process (Schein, 2010), then an organizational risk culture is increasingly more complex given the unpredictability and multiple risks faced by an organization. Undoubtedly, one of the most important elements of ERM is creating a risk culture (Lam, 2003).

The influence of leadership style on organizational culture gain CR value of $3.64 > 1.96$, which means the third hypothesis which predicts relationship between leadership style and implementation of risk management through organizational culture is significant. It shows that a good leadership style if not supported by appropriate organizational culture will affect the effectiveness of risk management. Implementation of risk management required leadership with characters that are not only concerned with the external factors in the direction of changing the organizational culture but also internal factors to give a subordinate



role in the decision. a leader who is able to communicate with either one of them dig up information on potential risks of each process conducted by his unit.

In summary, all the independent factors exert an effect upon performance, although the impact and form of the effect differ. The finding of indirect links between the three forms of leadership style and implementation of risk management supports the proposition developed earlier, leading to the suggestion that sufficient evidence is found to argue that the link between leadership style and implementation of risk management is mediated by organizational culture.

CONCLUSIONS

Perhaps it is not too surprising that a survey of executives in business would view risk management effectiveness from a leadership style and organizational culture. Over the last decade, corporations have been increasingly formalizing and elevating the management of risk from a management issue to a leadership level position. In a world of uncertainties, organizations should be implementing ERM as an approach to better manage risk. ERM is expected to be integrated within the organization so that risks are addressed systematically and consistently, not on an ad hoc basis.

Having a strong risk culture means that employees understand an organization's strategic orientation, and risk appetite; further they can freely discuss about prevailing risk and opportunities. Transforming the perception of risk with the change in strategy is a dynamic process. Strong leadership, commitment and engagement across the organization can change the way an organization behaves and makes decisions. Risk management should be successfully embedded into an organization when the beliefs and behaviors of employees of that organization reflect risk understanding, risk awareness, and the implementation of risk management framework.

Regarding this study's conclusion about the importance of strong leadership for successful ERM, managers should become engaged in fulfilling their risk management roles. This involves leading the way by institutionalizing systematic risk identification, assessment, and response initiatives, along with the supervisory and cultural elements that will support ERM activities. Attention to these aspects of managing risk should help managers not only to



prepare for threats to the organization and its assets, but also to take risks more intelligently and productively.

LIMITATION OF STUDY

Limitations in this study is to use only one insurance company owned by state-owned enterprises. In addition, this study only collects opinions from employees, both in middle and lower management who are headquartered. This is because the head office is the place where the policy or decision for the company as whole is made. In addition, this study uses only two measurements of the characteristics of the company to see its effect on the implementation of risk management with leadership style and organizational culture.

Further research that can sample only citizens and additional stakeholder groups could likely yield more insight into what influences a leader's ability to manage its risks. Although the factors maybe the same, it could be that, for example, non-executives would find the leadership style and organizational culture factors more important for perceptions of risk management effectiveness, which would be interesting to compare. Additional question or correlating the data with recent crises in a country might help tease this effect out.

REFERENCES

- Alkahtani, A. H. (2015). The Influence of Leadership Styles on Organizational Commitment: The Moderating Effect of Emotional Intelligence. *Business and Management Studies*, 2(1), 23-34.
- Alvesson, M. (2002). *Postmodernism and social research*. Open University.
- Campbell, J.P. and Freeman, S.J. (1991) 'Cultural Congruence, Strength and Type: Relationships to Effectiveness'. In Woodman, R.W. and Passmore, W.A. (eds) *Research in Organizational Change and Development*, Vol. 5. Greenwich, CT: JAI Press.
- Campbell, K. A. (2013). DOES NATIONAL RISK MANAGEMENT SIGNAL VIRTUE-BASED LEADERSHIP?
- Çetin, S. (2012). Leadership in public sector: A brief appraisal. *Journal of Social Sciences*, 2(32), 75-85.



- Choi, Y., Ye, X., Zhao, L., & Luo, A. C. (2016). Optimizing enterprise risk management: a literature review and critical analysis of the work of Wu and Olson. *Annals of Operations Research*, 237(1-2), 281-300.
- Committee of Sponsoring Organizations of the Treadway Commission. (2004). The (COSO). (2004). *Enterprise risk management—integrated framework*.
- Cooper, T., Faseruk, A., & Khan, S. (2013). Examining practitioner studies to explore ERM and organizational culture. *Journal of management policy and practice*, 14(1), 53.
- DeCaro, D. A. (2005). Facilitative Government and the Autonomy-Supportive Society. *Student Honors Theses*, 178.
- DeCaro, N. E. (2005). *An investigation of the relationship of initiating structure, consideration and gender perception: An examination of the path-goal theory* (Doctoral dissertation, Dissertation, William A. Reed, Ph. D. Faculty Mentor and Chair).
- Deshpandé, R., Farley, J. U., & Webster Jr, F. E. (1993). Corporate culture, customer orientation, and innovativeness in Japanese firms: a quadrad analysis. *The journal of Marketing*, 23-37.
- Djohanputro, Bramantyo. (2013). *Manajemen Risiko Korporat Terintegrasi: Panduan Penerapan dan Pengembangan*. Jakarta: PPM
- Farrell, J. M., & Hoon, A. (2009). What's your company's risk culture. *Bloomberg Businessweek*, 12.
- Fleishman, E. A. (1957). A leader behavior description for industry. *Leader behavior: Its description and measurement*, 103, 10-119.
- Gerbing, D. W., & Anderson, J. C. (1992). Monte Carlo evaluations of goodness of fit indices for structural equation models. *Sociological Methods & Research*, 21(2), 132-160.
- Gefen, D., Straub, D., & Boudreau, M. C. (2000). Structural equation modeling and regression: Guidelines for research practice. *Communications of the association for information systems*, 4(1), 7.
- Hair, J. F., Black, W. C., Babin, B. J., Anderson, R. E., & Tatham, R. L. (2006). Multivariate data analysis 6th Edition. *Pearson Prentice Hall. New Jersey. humans: Critique and reformulation. Journal of Abnormal Psychology*, 87, 49-74.



- House, R. J. (1996). Path-goal theory of leadership: Lessons, legacy, and a reformulated theory. *The Leadership Quarterly*, 7(3), 323-352.
- House, R. J., & Dessler, G. (1974). The path-goal theory of leadership: Some post-hoc and a priori tests. in J. G. Hunt & H. Larson (eds.), *Contingency approaches to leadership*. Carbondale: Southern Illinois University Press.
- House, R. J., Hanges, P. J., Javidan, M., Dorfman, P. W., & Gupta, V. (Eds.). (2004). *Culture, leadership, and organizations: The GLOBE study of 62 societies*. Sage publications.
- Huang, X., Iun, J., Liu, A., & Gong, Y. (2010). Does participative leadership enhance work performance by inducing empowerment or trust? The differential effects on managerial and non-managerial subordinates. *Journal of Organizational Behavior*, 31(1), 122-143.
- Hult, T., Ketchen, D., Cui, A., Prud'homme, A., Seggie, S., Stanko, M., Xu, A. and Cavusgil, S. (2006), An assessment of the use of structural equation modelling in international business research, *Research Methodology in Strategy and Management*, Vol.3, pp.385-415
- Kane, J., & Patapan, H. (2006). In search of prudence: The hidden problem of managerial reform. *Public Administration Review*, 66(5), 711-724.
- Kaplan, R. S., & Mikes, A. (2014). Towards a Contingency Theory of Enterprise Risk Management. *Harvard Business Review*.
- Kaplan, R. S., & Mikes, A. (2014). Towards a Contingency Theory of Enterprise Risk Management. *Harvard Business Review*.
- Kimbrough, R. L., & Compton, P. J. (2009). The relationship between organizational culture and enterprise risk management. *Engineering Management Journal*, 21(2), 18-26.
- Kohli, A. K. (1989). Effects of supervisory behavior: The role of individual differences among salespeople. *The Journal of Marketing*, 40-50.
- Koornpai, S. (2010). Comparison among organizational cultures affecting organizational effectiveness: A case study of Thailand's Public Enterprises. Doctor of Public Administration, National Institute of Development Administration.



- Lam, J. (2003). *Enterprise Risk Management: From Incentives to Controls*. San Francisco: John Wiley & Sons.
- Levy, C., Lamarre, E., & Twining, J. (2010). Taking control of organizational risk culture. *McKinsey & Company*.
- Littrell, R. F., & Nicolae Valentin, L. (2005). Preferred leadership behaviors: exploratory results from Romania, Germany, and the UK. *Journal of Management Development*, 24(5), 421-442.
- Lowell, L. (2015). Business Leadership and Risk Management. *International Journal of Innovation and Scientific Research*, 15(2), 361-363.
- Mantere, S., & Vaara, E. (2008). On the problem of participation in strategy: A critical discursive perspective. *Organization Science*, 19(2), 341-358.
- Mintzberg, H. (2003). *The strategy process: concepts, contexts, cases*. Pearson education.
- Moeller, R. R. (2007). *COSO enterprise risk management: understanding the new integrated ERM framework*. John Wiley & Sons.
- Ogbonna, E., & Harris, L. C. (2000). Leadership style, organizational culture and performance: empirical evidence from UK companies. *International Journal of Human Resource Management*, 11(4), 766-788.
- Perrin, T. (2009). *Risk Appetite: The Foundation of Enterprise Risk Management*. London, UK: Towers Perrin.
- Power, M. (2009). The risk management of nothing. *Accounting, organizations and society*, 34(6), 849-855.
- Quinn, R. E. (1988). *Beyond rational management: Mastering the paradoxes and competing demands of high performance*. Jossey-Bass.
- Senge, P. (1990). *The fifth discipline: Mastering the Five Practices of the Learning Organization*. New York.
- Schein, E. H. (2010). *Organizational culture and leadership* (Vol. 2). John Wiley & Sons.
- Smith, V., Alvesson, M., Berg, P. O., Martin, J., Trice, H. M., & Beyer, J. M. (1993). Approaching organizational culture versus cultural approaches to organizations: let's close the gap.



- Stogdill, R.M. (1948) 'Personal Factors Associated with Leadership', *Journal of Psychology*, 25: 35–71.
- Teas, R. K. (1981). An empirical test of models of salespersons, job expectancy and instrumentality perceptions. *Journal of Marketing Research*, 209-226.
- Thomya, W., & Saenchaiyathon, K. (2015). The effects of organizational culture and Enterprise Risk management on organizational performance: A conceptual framework. *International Business Management*, 9(2), 158-163.
- Rahgozar, H., Afshangian, F., & Zare Ehteshami, K. (2012). The Relationship between Organizational Culture and Knowledge Management. (A Case Study at the University of Shiraz). *Recuperado el, 1*, 3198-3207.
- Yukl, G. (2006). & (2002). *Leadership in Organizations*, (5th ed), Englewood Cliffs, NJ: Prentice Hall)
- Pratt, Z. L. (2004). An investigation of the relationships between external environment, mission and strategy, leadership, organizational culture, and performance. *Unpublished Ph. D., Michigan State University, United States--Michigan.*
- Kane, J., & Patapan, H. (2010). The artless art: Leadership and the limits of democratic rhetoric. *Australian Journal of Political Science*, 45(3), 371-389.



**PUBLIC GOVERNANCE AND CORPORATE ETHICS: A CROSS NATIONAL
ANALYSIS**

Sofik Handoyo

Faculty of Economics and Business, Universitas Padjadjaran

Sofik.handoyo@unpad.ac.id

ABSTRACT

This study aims to investigate the association of public governance and corporate ethics. Motive of the study was driven by numerous corporate scandals in various countries and practice of good governance both in private and public sector. The study was intended to reveal, whether the country that apply good practice of governance will also lead good practice of corporate ethics in that country.

The study adopted exploratory research design which are public governance and corporate ethics proxied as two independent variables. Public governance was represented by attributes namely public accountability, control of corruption, effectiveness government, regulatory quality, rule of law, regulatory quality and political stability. World Governance Index (WGI) was adopted to measure Public Governance. Meanwhile, data from component measurement of Global Competitiveness Index (CGI) was adopted to measure Corporate Ethics. The study applied bivariate correlation analysis and involved 140 countries member of World Bank Organization.

The results show that all public governance attributes are positively and significantly associated with corporate ethics. Pearson correlation coefficient indicates that all attributes of public governance have strong correlation (Pearson correlation (r) > 0.6), except for public accountability attribute. The result implies that the practice of good governance in governmental sector have potential impact on how private sector running their business organizations.

Keywords: *Public Governance; Corporate Ethics; Good Governance; Accountability; Bivariate Correlation*

JEL Classifications: *M14, G34*



INTRODUCTION

In today's hypercompetitive world, company operates in a complex global market and corporate governance becomes essential to regulate the economic and social relationships (Arrigo, 2006). Ethical issues are a major concern for businesses because they have significant impacts on various stakeholders including the company, customers, employees, shareholders, and society in general (Ekici and Onsel, 2013). Recent corporate scandals have led to public pressure to reform business practices and increase regulation (Coglianese et al, 2004). The collapse of corporate giants such as Enron and Worldcom due to corruption and mismanagement reminded the world of the importance of concepts like corporate governance, social responsibility and business ethics (Tasyir and Pasarcik, 2013). The recent scandals themselves demonstrate that lax regulatory institutions, standards, and enforcement can have huge implications for the economy and for the public (Coglianese et al, 2004)

The public is demanding accountability and responsibility in corporate behavior. The governance of corporations has become a central item on the public policy agenda (Coglianese et al, 2004). The government plays an important role in encouraging businesses to behave in an ethical manner, both by encouragement and coercion, as it cannot be assumed that all businesses will behave ethically without enforcement of regulations (Breslin, 2017). Hurst (2004) considers that continuing examples of questionable behavior by individual employees and executives have given rise to critical questions of how corporate ethics efforts can be improved and can address the underlying causes of misconduct, as well as the growing demands for proactive, socially responsible and sustainable business practices. It is widely believed that it will take more than just leadership by the corporate sector to restore public confidence in our capital markets and ensure their ongoing vitality. It will also take effective government action, in the form of reformed regulatory systems, improved auditing, and stepped up law enforcement (Coglianese et al, 2004).

Although government play an important role in ensuring that business operate in an ethical matter, ultimately, the responsibility to do so lies with the business. It would be impossible for government to oversee all operations to such an extent that they could force all businesses to behave ethically. Such strict supervision would most likely adversely affect the smooth operation of the market. Government agencies hold the duty to promote ethics as



much as possible without unduly restricting businesses (Breslin, 2017). Fundamental role for government to undertake the role of the analyst, seeking to identify the conditions under which to deploy different configurations of regulatory institutions, standards, and enforcement practices (Coglianese et al, 2004). Generally, it seems that corporations follow the lead of the government on equity, social and employment issues and primarily on compliance matters where there is no option (Welsh, 2012)

Public governance refers to the formal and informal arrangements that determine how public decisions are made and how public actions are carried out, from the perspective of maintaining a country's constitutional values when facing changing problems and environments. The principal elements of good governance consist of accountability, transparency, efficiency, effectiveness, responsiveness and rule of law (OECD, 2011). The greatest current challenge is to adapt public governance to social change in the global economy (OECD, 2011). There are clear links between good public governance, investment and development (OECD, 2011). The greatest current challenge is to adapt public governance to social change in the global economy. Thus, the evolving role of the State needs a flexible approach in the design and implementation of public governance (OECD, 2011).

Business ethics or corporate ethics is related to moral norms and values (Tasyir and Pasarcik, 2013) and unfortunately, companies do have moral duties in a secondary sense (Valquez, 2002). Factors influencing ethical behavior can be grouped into individual characteristics of the decision maker, organizational factors, situational and contextual factors, social and cultural environment, business/industry environment, and governmental and legal environments (Ekici and Onsel, 2013). The actual ethical performance of individuals and the companies they represent differs among and between countries, often significantly and these variations can in large part be explained by the differences in political, economic, and social institutions (Sullivan, 2009). Underlying the very roots of corporate governance, and providing its moral compass, is ethics (Sullivan, 2009).

Even though potential impacts of political and legal environments of business on ethical behavior of firms have been conceptually recognized, not much evidence has been produced to clarify their role (Ekici and Onsel, 2013). La Porta et al. (1999) have explored the determinants of the quality of government. They verified that rich countries have better



government than poor ones and that there is clear evidence that the historical circumstances (measured by ethnos linguistic, heterogeneity, legal origins and religion) affect government performance. Systems of corporate governance diverge significantly between different countries (Lashgari, 2004). Therefore, understanding public governance cross countries and analysis its association with practice of corporate ethics among private sector in that country will be valuable to answer the role of government in facilitating good business practice.

In general, this study investigates the relationship of good public governance practice and the good corporate governance practice. Specifically, the study tries to reveal the relationship of public governance attributes namely public accountability, control of corruption, effectiveness government, regulatory quality, rule of law, regulatory quality and political stability with corporate ethics. The study involves countries listed as member of world bank and adopts exploratory research approach. Empirical analysis using statistic correlation is applied in this study to justify the relationship of public governance attributes and corporate ethics.

LITERATURE REVIEWS AND HYPOTHESES DEVELOPMENT

Public Accountability and Corporate Ethics

Public accountability is the hallmark of modern democratic governance (Boven, 2003). Public accountability which measures capacity of government to ensure proper responsiveness to society and includes different aspects of the political process, civil liberties and political rights, measuring the extent to which citizens are able to take part in the selection of their governments (Bota-Avram, 2014). Public accountability captures perceptions of the extent to which a country's citizens are able to participate in selecting their government, as well as freedom of expression, freedom of association, and a free media (Kaufmann et al, 2010). Public accountability enables the citizen as stakeholder being part of the big organization called as a country. Every activity done by the countries on behalf of the citizen, it must be a subject government's accountability to public.

The public outcry over the recent scandals has made it clear that the status quo is no longer acceptable, the public is demanding accountability and responsibility in corporate



behavior. Business ethics can help a manager make his/her company more accountable and transparent (Tasyir and Pasarcik, 2013). The rise of worldwide democracy, accountability, and transparency has reduced the tolerance for corrupt behavior, and raised governance standards for both companies and nations as a whole (Sullivan, 2009). Good practice of public accountability by the government will create conducive environment both in public and private sector. Business entities will have tendency to adopt what that government already practiced in terms of implementation of good governance. Therefore, the hypothesis can be formulated as follows:

Hypothesis 1: Public accountability is positively and significantly associated with corporate ethics

Regulatory Quality and Corporate Ethics

Some degree of legislation is necessary to ensure that businesses comply with their ethical obligations and the public does not suffer as a result of dishonest business practices (Breslin, 2017). General understanding, regulatory quality is quality of state to manage the resources and the rules of the game for the general interest (Rhodes, 1997). Regulatory quality is designed to provide estimates over the effects of the policies which are perceived as market-unfriendly, such as price controls or inadequate bank supervisions, or excessive regulation which might affect business development (Bota Avram, 2014). Regulatory quality encourages the entry of foreign investors by eliminating market unfriendly policies such as price controls, government intervention, and restrictions on capital movement (Fazio and Talamo, 2008).

A sound regulatory environment for public and for the business sector economic activity, sound institutions, and government authority accountable to citizens are considered to be crucial to successful economic development (Bota Avram, 2014 and Kray and Tawara (2010). Good corporate governance practices cannot be imposed by fiat, even if promulgated by the highest levels of leadership. Similarly, companies will find it hard to comply with corporate governance regulations if there are no initiatives to improve the overall legal and regulatory climate in a country (Sullivan, 2009). Besides the legal characteristics of each



country, stakeholders also assume an important role in corporate governance (Vieira et al, 2010). Therefore, the hypothesis can be formulated as follows:

Hypothesis 2: Regulatory Quality is positively and significantly associated with Corporate ethics

Rule of Law and Corporate Ethics

Rule of law includes some indicators that estimate the extent to which public and citizens have confidence in and abide by the rules of society, including the effectiveness of the judiciary system and the security of property rights (Bota-Avram, 2014). It also measures the extent to which agents have confidence in and abide by the rules of the society, including the effectiveness and predictability of the judiciary, and the enforceability of contracts. Judicial independence is the driving force behind managers' perceptions of business ethics (Ekici and Onsel, 2013)

The government has a supervisory role in terms of building good practice of business ethics. Sustainable business depends much on the quality of institutions, such as contract enforcement, rule of law and property rights, as well as, business ethics (Sullivan, 2009). Anti-competitive behavior can occur when large organizations merge or are taken over, and when a large organization has a very substantial market share or a monopoly, there is always the temptation for it to act in an unethical manner, which will be detrimental to the public. The government must monitor and supervise such mergers, which are subject to antitrust law and to ensure that they are acting ethically and are not abusing a position of dominance (Breslin, 2017)

On the issue of regulatory design, decision makers need to understand better what makes different degrees of specificity and generality "right" for particular types of regulatory problems (Coglianese et al, 2004). Each business sector has different characteristic that lead different treatment of business ethics rules and regulation. However, the legal and regulatory framework within a national context sets the minimum standards of acceptable conduct in doing business, and reflects what society holds as fair and appropriate behavior by all types



and sizes of firms. Thus, compliance with national laws is the starting point for doing the right thing by private sector organizations (Sullivan, 2009).

Business ethics, in some sense, can be thought of as a means of ensuring that individuals working in organizations act in a positive way consistent with rule of law and other principles underpinning market economies and democratic governance (Sullivan, 2009). Laws and regulations of the countries in which companies operate constitute one of the values can values can be derived business ethics (Sullivan, 2009). In weak rule of law environments where a legal system to ensure ethical behavior cannot be relied on, there are few guarantees that other market players will behave transparently and fairly (Sullivan, 2009). Therefore, the hypothesis can be formulated as follows:

Hypothesis 3: Rule of Law is positively and significant associated with corporate ethics

Effectiveness Government and Corporate Ethics

Government effectiveness evaluates the perception over the inputs necessary for effective governance, such as the quality of public service provision, the competence of civil servants, the level of bureaucracy, the independence of the civil services from political influences and the credibility of government (Bota Avram, 2014). Government effectiveness facilitates foreign investors' activity through the reduction of heavy bureaucracy, procedures and the overall time it takes for any agent to complete them (Inter American Development Bank, 2001). The effectiveness of government activity is meant to serve the interest of the general population and the cooperation between public and private sectors is crucial for ensuring the good of the society (Bota Avram, 2014). Effective governance matters and, even more, it is a determinant factor for the effectiveness of the business environment.

Role of government in solving societal issues bases for ensuring a normative function of social and economic institutions (Kooiman, 1999). It refers the quality of public service provision, the quality of bureaucracy, and the credibility of the government's commitment to policies (Kaufmann, 2010). In other words, government effectiveness captures the capacity of the state to implement sound policies (Rammal and Zurbruegg, 2006). On the issue of enforcement, state and federal officials should analyze why some individuals and



organizations adhere responsibly to regulatory standards and why others do not. Such analysis would help enhance government's ability to pursue optimal enforcement, instead of under or over enforcement (Coglianese et al, 2004). It is obvious that concerns about the protection of property rights, ethics and corruption, undue influence, and government inefficiencies lead to an institutional environment that does not support a well-served economy (Ekici and Onsel, 2013). Government effectiveness can be also measured based on its successful to regulate good corporate governance proactive among business entities. It will be reflected on business ethic conduct practiced by private sector. Therefore, the hypothesis can be formulated as follows:

Hypothesis 4: Effectiveness government is positively and significantly associated with corporate ethics

Political Stability and Corporate Ethics

Political stability and absence of violence refers to the possibility of violent changes in government's structure and combines several indicators which express the potential likelihood that the government in power could be overthrown through unconstitutional or violent changes (Bota Avram, 2014). Investor keeps many factors while doing investment at any country and political stability is one of them. Whenever there are instable political conditions, industries get affected by many ways and one of them is quality due to employee behavioral changes. In instable political conditions, employee is affected with respect to society as well (Aslam and Sajid, 2008). Political stability may not directly influence the good practice of corporate governance of private sector, however, it facilitates at least with good atmosphere for business entities doing the right things. Conducive political situation enables the business entities applying corporate governance principles.

The close link between economy and the nation state constitutes one of the most prominent features of the industrial era, with political power significantly surpassing economic power (Coyle, 1999; Schwartz and Gibb, 1999). Into a global corporate code of conduct, tractates initiated by United Nations Universal Declaration of Human Rights (1948), the European Convention on Human Rights (1950), the Helsinki Final Act (1975), the OECD



Guidelines for Multinational Enterprises (1976), the International Labor Office Tripartite Declaration of Principles Concerning Multinational Enterprises and Social Policy (1977, and the United Nations Code of Conduct on Transnational Corporations (1972) showed how political aspect determining business practices. The tractate in general covers five major business areas: employee practices and policies; basic human rights and fundamental freedoms; consumer protection; environmental protection; and political involvements (Ferrell and Fraedrich, 1997). Therefore, the hypothesis can be formulated as follows:

Hypothesis 5: Political stability is positively and significantly associated with corporate ethics

Control of Corruption and Corporate Ethics

The government and business entities are two parties that are mutually benefits each other. Government's rules and regulation are aimed to regulate business practices of private sector. However, the private sector also has a contribution how the government must develop a rules and regulations. The private sector can be a force in developing solutions to the corruption problem, and companies around the world are taking charge. They are doing it in a multiplicity of ways. Some engage in collective action to reform the business climate to make it more transparent. Others push for ethical standards and fair practices in dealing with the government, as is the case with industry initiated integrity pacts (Sullivan, 2009). An important factor in dealing with corruption is the establishment of strong public and private regulating institutions (Sullivan, 2009)

Many researchers concluded that corruption whether in public or in private sector is not good for a business practice. Corruption will increase cost of transaction and at the end it will decrease competitiveness. The results of the research suggest that irregular payments and bribes are the most influential factors affecting managers' perceptions of business ethics in relatively more advanced economies, whereas intellectual property protection is the most influential factor affecting managers' perceptions of business ethics in less-advanced economies (Ekici and Onsel, 2013). To control corruption in the private sector context, a variety of legal and regulatory tools are often proposed (Sullivan, 2009). In that situation, role



of government in terms of combatting corruption practice is significant. Therefore, the hypothesis can be formulated as follows:

Hypothesis 6: Control of corruption is positively and significantly associated with corporate ethics

METHODOLOGY

Population and Sample

Population of this research is countries registered officially as member of world Bank. Until today (2017), total number of members in world bank is 214 countries (Population). Meanwhile, the sample was involved in this research is 140 countries of world bank members. Purposive sampling method was applied in this research. It refers to the purpose of availability the data in certain period of time of research investigation. The sample represents five continents namely Europe, America, Asia, Australia and Africa

Variable, Measurement and Data

This research involved two independent variables namely public governance and corporate ethics. Those variables were proxied as two independent variables due to the research's design is exploratory. Public governance attributes are represented by independent variable public accountability, government's regulatory quality, government's rule of law, effectiveness of government, country's political stability and government's control of corruption. Meanwhile, variable independent corporate ethics is attributes of countries' competitiveness. Attributes of public governance was measured using Corporate Governance Index (CGI) issued by World Bank. CGI is performance of public governance of countries around the world and globally adopted as international standard to measure public governance performance. Meanwhile, country's corporate ethics was measured using corporate ethics value as part of measurement countries' Global Competitiveness Index (CGI). CGI is published by World Economic Forum as performance indicator to measure countries' competitiveness. The data was used in this research is secondary data, which is



official publication of Worldwide Governance Index (WGI) and Global Competitiveness Index (GCI) from World Bank and World Economic Forum. The data was an open publication and downloaded directly from official websites of sources data. Time period of the data was used in this research is year 2015, which is the latest official publication available from the sources of data.

Analysis

Descriptive statistics analysis and bivariate correlation analysis were applied in this research. Descriptive statistics analysis was intended to describe the basic features of the data used in the study. They provide simple summaries about the sample and the measures. Meanwhile, bivariate correlation analysis in this study was used to test the degree of correlation between two independent variables. Furthermore, bivariate correlation analysis was used to justify the acceptance of proposed hypothesis. Pearson Correlation method was chosen in this research due to the data is categorized as interval scale.

RESULTS

Descriptive Statistic

World Bank Releases Worldwide Governance Indicator in interval value from minimum value of -2.5 (Weak governance performance) to +2.5 (strong governance Performance). Measurement of public governance is using six aggregate indicators are based on 31 underlying data sources reporting the perceptions of governance of a large number of survey respondents and expert assessments worldwide. As shown in Table 1, public governance attributes of 140 sample's countries show that the score is at moderate value (average value of Mean 0.10955). Standard deviation is also indicating that the sample's countries have homogeneity characteristics in terms of performance of public governance. It is supported by the statistic descriptive that the average value of standard deviation that shows relatively small in terms of the amount (0.929945). Even though there were always outliers with extreme performance (weak or strong), however in general we can conclude that



the samples are relatively have the same characteristic in terms of public its governance performance.

Table 1. Descriptive statistic of public governance

Variables	N	Minimu m	Maximu m	Mean	Std. Deviation
Government Accountability	14 0	-1.76	1.70	0.043 9	0.91321
Country's Political Stability	14 0	-2.54	1.49	0.041 7	0.84361
Government Effectiveness	14 0	-2.00	2.25	0.179 0	0.94776
Government Regulatory Quality	14 0	-1.86	2.26	0.192 9	0.92550
Government Control of Corruption	14 0	-1.33	2.29	0.076 6	0.98802
Government Rule of Law	14 0	-1.99	2.07	0.123 2	0.96157
AVERAGE				0.1095 5	0.929945

World Economic Forum developed countries' competitiveness index using interval scale from 1 (worst) to 7 (the best). One of the indicator of countries competitiveness index is corporate ethics value. Corporate ethic value is also measured using seven scale interval value (1 = worst and 7 = the best). Table 2 indicates that mean value of corporate ethics of 140 countries as sample is 4.1123 (Mean). With consideration 1 is the worst and 7 is the best, therefore, we can conclude that performance of country's corporate ethics is on moderate level. Information generated from Table 2 shows that standard deviation value is on low level mode (0.88333). It indicates that the variation value of the corporate ethics among samples is relatively low. Low standard deviation explains that the samples have relatively homogeneity



in terms of country's corporate ethics performance. The outliers were always present, however, the samples that have extreme value (worst or the best) are relatively small in terms of the number. Low value of standard deviation also indicates that the samples are in distribution normal mode.

Table 2. Descriptive statistic of corporate ethics

Variables	N	Minimum	Maximum	Mean	Std. Deviation
Country's Corporate Ethics	140	2.40	6.30	4.1123	0.88333

Correlation Analysis

Correlation is another way of assessing the relationship between variables. To be more precise, it measures the extent of correspondence between the ordering of two random variables. Correlation denotes the interdependency among the variables for correlating two phenomena. This research was developed to identify the relationships between two independent variables. Since the purpose of the research is investigating the relationship between two independent variables, bivariate correlation statistical analysis is believed as the right one. The results of the correlation analysis are presented in Table 3 bellow:

Table 3. Correlation Matrix

Pearson Correlation Matrix							
	Accountability	Political Stability	Government Effectiveness	Regulatory Quality	Control Corruption	Rule of Law	Corporate Ethics
Accountability	1						



Political Stability	0.649**	1					
Government Effectiveness	0.710**	0.730*	1				
Regulatory Quality	0.738**	0.701*	0.933**	1			
Control of Corruption	0.732**	0.762*	0.921**	0.884**	1		
Rule of Law	0.762**	0.759*	0.951**	0.938**	0.963**	1	
Corporate Ethics	0.481**	0.601*	0.801**	0.760**	0.872**	0.834**	1

** . Correlation is significant at the 0.01 level (1-tailed).

In this research, design of the correlation analysis is one way in term of the direction of correlation, which is a positive correlation. The argumentation of using one-way correlation analysis test is due to strong literature supporting the direction of the relationship between two variables. Pearson Correlation Matrix as presented in Table 3 indicates that among attributes of public governance (public accountability, government's regulatory quality, government's rule of law, effectiveness government, country's political stability and government's control of corruption) has strong correlation ($r > 0.6$). It implies that attributes of public governance constitute as integral indicator measurement and show linearity of association. Integrality and linearity have implication that performance of one attribute of public government will predict performance of other attributes of public governance. If one attribute get high score, it will also lead to high score the rest of public governance attributes.

Hypothesis Testing

In this research, there were six hypotheses proposed and the summary of the hypothesis is presented in Table 4. generally, the hypotheses predicted that public governance has positive and significant association with corporate ethics. specifically, the hypothesis proposes that attributes of public governance namely public accountability, government's regulatory quality, government's rule of law, effectiveness government, country's political stability and government' s control of corruption are positively and significantly associated with country's corporate ethics. The summary of the hypothesis testing is presented in Table 4 as follows:

Table 4. Summary of Hypothesis Testing

Hypothesis	Pearson Correlation Coefficient	Conclusion of Proposed Hypothesis
H1: Public accountability is positively and significantly associated with corporate ethics	0.481**	Supported
H2: Government's regulatory quality is positively and significantly associated with corporate ethics	0.760**	Supported
H3: Government's rule of law is positively and significantly associated with corporate ethics	0.834**	Supported
H4: Effectiveness government is positively and significantly associated with corporate ethics	0.801**	Supported
H5: Country's political stability is positively and significantly associated with corporate ethics	0.601**	Supported
H6: Government' s control of corruption is positively and significantly associated with corporate ethics	0.872**	Supported

** . Correlation is significant at the 0.01 level (1-tailed).

Based on information summarized in table 4, it concludes that all proposed hypotheses are supported. All public governance attributes show positive and significant correlation with corporate ethics. However, there is a note for correlation between public accountability and corporate ethics. Even though the correlation is positively and significantly, however the degree of correlation is moderate ($r = 0.481$). It means that public accountability as attribute of public governance has no convincing power to predict corporate ethics performance. However, in general we can still rely on public governance attribute overall to predict corporate ethic performance. The argumentation is supported by statistics results that the rest of public governance attributes show strong correlation with corporate ethics ($r > 0.6$).

Based correlation analysis as depicted in table 4, it implies that the country that has high score of public governance, therefore, corporate ethics score of that country will be also high. It means that good practice of public governance will have impact on good practice of corporate governance among private sectors in that country. Efforts of the government in terms of implementing principles of good public governance have contribution on how private sector organizations run their business based on good corporate governance principles. Therefore, the government has significant roles in creating good atmosphere that facilitates good practice of business among private sector organization.

CONCLUSION

The research concludes that public governance namely public accountability, government's regulatory quality, government's rule of law, effectiveness government, country's political stability and government's control of corruption are positively and significantly associated with country's corporate ethics. In general, the degree of correlation of public governance and corporate ethics is strong, even though there is attribute of public governance indicates moderate correlation. Referring to the result of the research, it implies that performance of the public governance correspondence with the performance of corporate ethics. It supports the theoretical framework that application of good government principles in governmental institution will affect to practice of good corporate governance in private sector.



Government plays important role in terms of conditioning infrastructure of business environment that practice good governance. Efforts of the countries in achieving good public governance will attract practice of business in private sector in the same direction. Private sector will follow the government actions in terms of implementing good practice of governance. Even though the linearity between public governance and corporate ethics was proven, however, motive of private sector adopting good governance practice is still questionable. Private sector may follow the government implementing good governance practice due to self-consideration. However, good practice of public governance also has possibility to forces the private sector to implement good corporate governance practice (not in private sector self-consideration mode) Therefore, it is suggested to do further research in order understand more detail the adoption of good practice of corporate ethics among private sector organization.

In order achieving good practice of corporate ethics, the state's must have commitment to combat corruption practice. By eradicating corruption behavior among state's officials, possibilities for in appropriate business practice that destruct and endanger the business environment can be minimized. Regulatory quality determines the achievement of the goal of regulation itself. By having law and regulations that truly consider business ethics and has power to force obedience among stakeholder, good practice of corporate ethics can be achieved. Domestic political stability enables the state to continue of national development program without any interferer. The state will have attention to develop the nation related good business practice if the domestic political condition is stable. Government effectiveness enables developing infrastructure of good business practice among private sector. Lastly, public accountability forces private sector behave positively in terms of responsibility toward stakeholder.

For further research, extension of time period of investigations is suggested. Longitudinal data panel with more countries involved is recommended. Furthermore, micro level analysis of adoption of corporate ethics is potential object of the research to be conducted. By conducting more details investigation of adoption good practice of corporate ethics among private sector, we will get more specific information about the role of public governance. since this research is explorative study, which is considered the association



among independent variables, in the future model of analysis using multiple regression analysis is recommended. using multiple regression analysis, the accumulative impact of public governance attributes toward corporate ethics will be discovered. Therefore, analysis impact of good public governance practice toward good corporate governance practice is relevance to be investigated.

REFERENCES

- Arrigo, Elisa. (2006). Code of Conduct and Corporate Governance. *Symphonya Emerging Issues in Management*.
- Aslam , M Shahzad., Ali Sajid., (2008). “Effect on Organizations and Quality due to Changed Employee Work Behaviors caused by Political Instability in Developing Countries”. 1th QMOD Conference. Quality Management and Organizational Development Attaining Sustainability From Organizational Excellence to Sustainable Excellence; 20-22 August; 2008 in Helsingborg.
- Bowen, Marks. (2003). Public Accountability. Paper for the EGPA annual conference, Oeiras Portugal September 3-6, 2003 to be presented in workshop 8 (Ethics and integrity of governance).
- Breslin, Connor. (2017). “Role of Government in Business Ethics” (<http://smallbusiness.chron.com/role-government-business-ethics-65128.html>, Accessed, 06 March, 2017).
- Bota-Avram, Christina. (2014). *Transylvanian Review of Administrative Science*.
- Coglianesi, Cary, Thomas J. Healey, Elizabeth K. Keating, and Michael L. Michael, “The Role of Government in Corporate Governance,” Regulatory Policy Program Report RPP-08 (2004), Cambridge, MA: Center for Business and Government, John F. Kennedy School of Government, Harvard University.
- Coyle, D. (1999). *The Weightless World: Strategies for Managing in the Digital Economy*. Oxford: Capstone Publishing Ltd.
- Ekici, Ahmet., Onsel, Sule. How Ethical Behavior of Firms is Influenced by the Legal and Political Environments: A Bayesian Causal Map Analysis Based on Stages of Development.



- Fazio, G., Talamo, G.M.C. (2008), “How Attractive is Good Governance for FDI?”, in J. Jay Choi, Sandra Dow (ed.) , “Institutional Approach to Global Corporate Governance: Business Systems and Beyond”, International Finance Review, Volume 9, Emerald Group Publishing Limited.
- Ferrell, O.C. & Fraedrich, J. (1997). Business Ethics. Boston: Houghton Mifflin.
- Hurst, N. E. (2004). Corporate Ethics, Governance and Social Responsibility: Comparing European Business Practices to those in the United States, pp. 1-68.
- Inter American Development Bank (2001), “Competitiveness: The Business of Growth: Economic and Social Progress in Latin America”, 2001 Report, Research Department, Inter American Development Bank, Washington D.C, USA.
- Kaufmann, Daniel., Kraay, Aart., Mastruzz. (2010). “The Worldwide Governance Indicators: Methodology and Analytical Issues. Draft Policy Research Working Paper. World Bank.
- Kooiman, J. (2003). *Governing as Governance*, London: Sage.
- Kraay, A. and Tawara, N. (2010). ‘Can Disaggregated Indicators Identify Governance Reform Priorities?’, World Bank Policy Research Working Paper No. 5254, The World Bank Development Research Group.
- La Porta, R., Lopez-de-Silanes, F., Shleifer, A., & Vishny, R. (1999). The Quality of Government. *Journal of Law, Economics, and Organization*, pp. 222-279.
- Lashgari, M. (2004). Corporate Governance: Theory and Practice. *The Journal of American Academy of Business*, pp. 46-51.
- OECD, (2011). “Policy framework for investment user’s toolkit”. A publication of the Investment Division of the OECD Directorate for Financial and Enterprise Affairs.
- Rhodes, R.A.W., *Understanding Governance. Policy Networks, Governance, Reflexivity and Accountability*, Buckingham: Open University Press, 1997.
- Rammal, H., & Zurbruegg, R. (2006). The Impact of Regulatory Quality on Intra-Foreign Direct Investment Laws in the ASIAN Markets. *International Business Review*, 15 (4), 401-414.
- Schwartz, P & Gibb, B. (1999). When Good Companies Do Bad Things: Responsibility and Risk in an Age of Globalization. N.Y.: John Wiley & Sons.



- Sullivan, John D. (2009). *The Moral Compass of Companies: Business Ethics and Corporate Governance as Anti-Corruption Tools*. International Finance Corporation. 2121 Pennsylvania Avenue, NW Washington.
- Tasyir, Eyup Aygun., Pazarcik, Yener. (2013). Business ethics, social responsibility and corporate governance: Does the strategic management field really care about these concepts? *Procedia - Social and Behavioral Sciences*.
- Valques, Manuel G. (2002). *Business ethics: concepts and cases*. (5rd ed.). Prentice Hall, USA.
- Vieira, Inês Silva., Jorge, Maria João., Canadas, Natália Maria Rafael Prudêncio. (2010). "Corporate Governance, Ethics and Social Responsibility: Comparing Continental European And Anglo-Saxon Firms". *Proceeding Conference on Environmental Management And Accounting*.
- Welsch, Ian. (2012). "How Important is Government Regulation of Business?". <http://hr.toolbox.com/blogs/search-for-mutual-success/how-important-is-government-regulation-of-business-50946> (Accessed, 06 March, 2017).



**SIMAKU[®]-SEKOLAH: THE IMPLEMENTATION OF MANAGEMENT
INFORMATION SYSTEMS AND ACCOUNTING FOR SCHOOL SOFTWARE
USING WEB-BASED APPLICATIONS TO ACHIEVE GOOD SCHOOL
GOVERNANCE**

Suryo Pratolo

Misbahulanwar

Bambang Jatmiko

University Muhammadiyah Yogyakarta

suryo@umy.ac.id

Abstract

To realized Indonesia as a leading country, the quality of human resources is the one of the key aspects. School becomes a vehicle to build and improve the quality of human resources. School is a forms of organization that can not be separated from the management aspect, a good school should be supported by good management including financial management. Good management should be guided by good governance. Without good governance, the management mechanism does not have a foothold in making decisions on it. To make good decisions in school financial affairs, management information and accounting system are needed to create the effectiveness and efficiency of the strategic and tactical decisions. For this reason, the application SIMAKU for school was built and applied. SIMAKU for school is a web-based application to support financial management and accounting aspects of the school that begins from planning and budgeting, financial administration and financial reporting in accordance with accounting standards in Indonesia, namely PSAK 45.

Keywords: *human resource, financial management, good governance, information system, SIMAKU for school, PSAK 45*

JEL Classification: *M15*



BACKGROUND

Human resources (HR) is one of the main supporters of the national development success where education has a strategic role. The study results Programme for International Student Assessment (PISA) in 2015 suggests that the quality of education in Indonesia was ranked 69 out of 76 countries (pikiran rakyat, 2016), while the results of the study by Trends in International Mathematics and Science Study (TIMSS) shows Indonesia students is ranked 36 out of 49 countries in terms of doing scientific procedures. The condition shows that the development of human resources in Indonesia faces many challenges.

In the Law on National Education System (Education) Article 1, paragraph 1 is said that education is a conscious effort to create an atmosphere of learning and the learning process so that learners are actively developing the potential for him to have the spiritual power of religion, self-control, personality, intelligence, character , as well as the skills needed him, society, nation and state (Republik Indondonsia, 2003). Education can not be separated from how far the quality of management education, which is a process of planning, organizing, implementation and oversight in managing resources such as people, money, material, method, machine, market, time and information to achieve the purpose of effective and efficient in the field of education.

Good management should be based on good governance. Governance is broader aspects of management, representing the interests of the organization that directs the management on all aspects of the organization and oversees the overall function of the organization. Governance is used to set appropriate policies and procedures to ensure that things are done in a proper manner while the management related to how to do things the right way (Suryo, 2014). Good governance means good referral to the management, so that if an organization has good governance, is expected to be realized a good management anyway.

In carrying out management based on good governance, the role of information technology (IT) is very helpful. Rapid technological developments today affect various areas of human life, especially the development of IT.



THEORY

Organization Theory

According to Lubis and Hussein (1987), the organization theory is a set of scientific knowledge that discuss the mechanism of cooperation of two or more systematically to achieve a predetermined goal, which includes classical organization theory, organizational theory neoclassical and modern organization theory. Based on organizational theory can be used to explain that the organization of the school in addition to realizing the internal management classic that includes roles and responsibilities, internal control and others, also have to make personnel to provide psychological support to the organization. Besides that, the organization also harur open to external conditions, especially the development of IT.

Agency and Steardship Theory

It is important in the theory of the Agency is the authority given to an agent to act in the interests of the owners. Agency theory produce an important way to explain the competing interests between managers and owners is an obstacle. While the stewardship theory, managers tend to try to provide maximum benefit to the organization with its own objectives rather than selfish.

Stewardship theory has a psychological and sociological roots designed to explain a situation where the manager as a steward and act in the interests of the owner (Donaldson & Davis, 1991). In theory stewardship manager will behave according to common interests. When the steward and owner's interests are not the same, the stewards will strive to work together rather than against it, because the stewards felt common interests and behave in accordance with the owner's behavior is rational consideration as steward rather look at efforts to achieve organizational goals. With this stewardship theory unexplained phenomena that in running the school organization must be based on community service.

Budget

A budget is a quantitative plan the activities of an organization to identify the resources and commitment needed to meet the objectives of the organization during the



budgeted period. Budgeting is the creation of an action plan expressed in financial size. Budgeting plays an important role in planning, control and decision-making. Budget also to improve coordination and communication.

Financial Management based on *Good Governance*

To perform financial management through budgeting and accounting, there are two concepts that need to be considered: concept Money Follow Function (MFF) and the concept of Value for Money (VfM). The concept is simple MFF explained that the budget allocations should be based on the function of each responsibility center responsible for the budget.

VfM is the management concept of public sector organizations which rely on three main elements, namely the economy, efficiency, and effectiveness (Mardiasmo, 2002). Economy, is the acquisition of inputs (input) with a certain quantity and quality at the lowest price. Economics is the ratio between the input (the case) with the input value (which it should).

Information Technology

IT, is a general term for any technology that helps people to create, modify, store, communicate and/or disseminate information. Developments in information technology affect the implementation of the company's financial management system that will generate information quickly and accurately in the context of planning, control and decision-making in the field of financial management and general management.

DEVELOPMENT SIMAKU FOR SCHOOL WEB BASED SOFTWARE

School SIMAKU web-based application developed using the programming language PHP with CodeIgniter framework as a back-end, using a MySQL database and Bootstrap, a front-end web framework that is open-source, as its design. The model used is a model development Agile, which prioritizes flexibility to changes that occur during development. Even alterations or additions during the last phase was resolved when using this model.

Principles of Agile Model, among others,

- Interaction and personnel is more important than processes and tools,



- Software that works is more important than a complete documentation,
- Collaboration with clients is more important than the contract negotiations,
- Responsiveness to change is more important than following the plan.

Agile models can also be interpreted group of models in software development that are based on the same principles or short-term systems development that require rapid adaptation of the developer to change in any form. Implementation is done periodically. Wherein each touring after the release, the team first analyzed the need for fi tour that will be developed next, then design it so that the fi tours can be made or developed in the system (method of iterative and incremental model).

OUTPUT of THE SIMAKU for SCHOOL

Main Menu

Output from the Main Menu of SIMAKU for School is showed on figure 1a, the menu settings.



Figure 1a.

No	Kode Unit	Nama Unit	Nama Pimpinan	NIP	Actions
1	01.00	Pengelola Yayasan	dr. Syaifq, PA	011	update hapus
2	01.01	Pengelola Yayasan (otorisator 2)	Widyatini Wijaya, SE, MM	002	update hapus
3	01.02	Keuangan Yayasan (otorisator 1)	Atik Damayanti	003	update hapus
4	02.00	SD Nusantara	Joko Suranto, S.Pd	001	update hapus
5	02.01	SD Nusantara	Joko Suranto, S.Pd	001	update hapus
6	03.00	SMP Nusantara	Sri Rullyanti A.Mik	006	update hapus
7	03.01	SMP Nusantara	Sri Rullyanti A.Mik	006	update hapus
8	04.00	SMA Nusantara	Drs. Suwanto, MM	007	update hapus
9	04.01	SMA Nusantara	Drs. Suwanto, MM	007	update hapus
10	05.00	SMK Nusantara	R. Didik Prasetyobudi, S.Pd., M.Pd	008	update hapus

Figure 1b.

“Unit Kerja” menu (figure 1b) is used to register the school entity that will replenish the budget. “Pagu” menu is used to set the budget ceiling for each school entity. How to set the budget sources ceiling and the amount of funds allocated from each source for each school entity shown figure 2a and figure 2b.

Kode Pagu (maks. 3 karakter):
Kode Pagu
Sumber Pagu (maks. 50 karakter):
Sumber Pagu
Besar Pagu:
Besar Pagu
Simpan

Figure 2a.

Kode Unit: 02.01
Nama Unit: SD Nusantara
Sumber Pagu SPP: 150000000
Sumber Pagu Uang Gedung: 500000000
Simpan

Figure 2b.

“Password” menu is used to set the user name and password for each school entity. Each school entity will be given access entry / login with user name and password given by the admin. Display menu password settings are as follows (figure 3):

Kode Unit:
Nama Unit:
Nama User:
Password :
Simpan

Figure 3.

To adjust the nomenclature of budget items and account activity, use menu Activity Nomenclature and Code (MAK) and Chart of Account (CoA).

Planning & Budgeting output

The settings menu for the work unit / sub-unit work begins by charging vision and mission, followed by determining the activities to be performed for each business process / field, designing school planning to use the menu shown in figure 4a and figure 4b:



Figure 4a.



Figure 4b.

For filling activities according to business process use the menu shown in figure 5a and figure 5b:

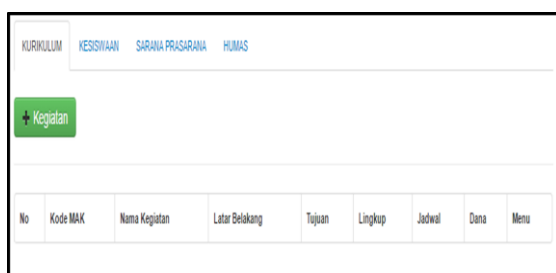

Figure 5a.

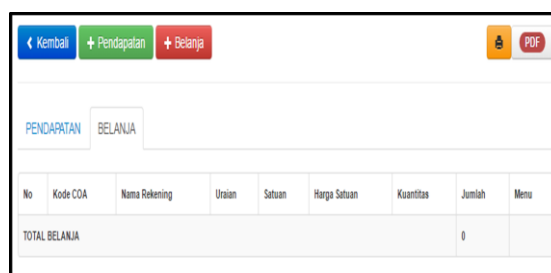

Figure 5b.

Click “Activity” menu to charging the activities to be carried out, defining the activities to be carried out, followed by a detailed charging on detailed income and expenditure.

Financial Administration

After login into financial administration menu in a particular school entity, there will be “penatausahaan” button, click it, then click the submission of the SPP (figure 6a). Next will be displayed the activity budget has been made as figure 6b.



Figure 6a.

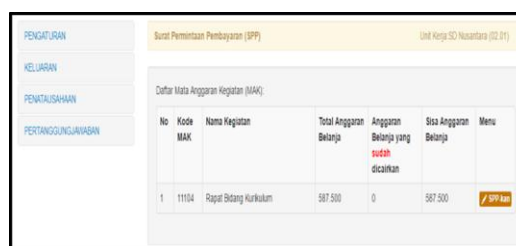

Figure 6b.

After click “SPP-kan”, it will display a list of activities that will be proposed (figure 7a). Furthermore, the content of submissions spp nominal rate and click process. To complete the submission process then click the “SPP Process” (figure 7b).

Kode MAK	Nama Kegiatan	Besar Anggaran	Anggaran yang SUDAH dicairkan	Sisa Anggaran
11104	Rapat Bidang Kurikulum	587.500	0	587.500

Jumlah Anggaran yang diajukan:

PROSES

Figure 7a.

No	Kode MAK	Nama Kegiatan	Anggaran yang diajukan	Menu
1	11104	Rapat Bidang Kurikulum	500.000	Rinci Ubah Batal
TOTAL			500.000	

PROSES SPP

Figure 7b.

Authorization “SPP” carried out by the unit (the unit code xx.00) by clicking on the button in the menu “penatausahaan” and “otorisasi SPP”

Sistem Informasi Manajemen Keuangan Selamat Datang 0200(SUB UNIT) , KELUAR

REKAPITULASI SUB UNIT **BERANDA**

PENATAUSAHAHAN Unit Kerja: SD Nusantara (02.00)

OTORISASI SPP Selamat datang di Sistem Informasi Manajemen dan Akuntansi Keuangan (SIMAKU)

PERTANGGUNGJAWABAN Awal Anggaran : 01 February 2017 - Akhir Anggaran : 31 March 2017.
Tinggal 42 hari lagi.

Figure 8.

“SPP” will be displayed list to do authorization. Authorization is done by clicking the “setuju” button. Once done click on the authorization of the table displays activities in “SPP-kan”. To approve the click of a “setuju” button to agree.

No	No. SPP	Tgl. Penyajian	Otorisasi Pimpinan	Status SPP	Menu
1	1/SPP/02.01/17/02/2017	17-02-2017	Belum di-otorisasi	Belum diverifikasi	Lihat rinci Otorisasi

Figure 9a.

SETUJU [BATAL](#)

Surat Permintaan Pembayaran (SPP)

Nomor: Tanggal Penajian: Tahun Anggaran: Unit Kerja:

1/SPP/02.01/17/02/2017 | 17-02-2017 | 2017 | SD Nusantara

No	Kode MAK	Nama Kegiatan	Anggaran	Anggaran yg pernah diterima	Anggaran yg tersedia	Anggaran yg diminta
1	11104	Rapat Bidang Kurikulum	587.500	0	587.500	500.000
TOTAL						500.000

Figure 9b.



After the click the “setuju” button to agree, entity should read the integrity pact and a password as a form of control, then click Authorize. After conducting further authorization shown List SPP with the status that has been authorized:

Figure 10a.

No	No. SPP	Tgl. Penyajian	Otorisasi Pimpinan	Status SPP	Menu
1	1/SPP/02.01/17/02/2017	17-02-2017	Sudah di-otorisasi	Belum diverifikasi	Tampilkan Lihat rinci

Figure 10b.

SPM filings made by the finance bureau operator by clicking on the button SPM Creation. After clicking on the numbers displayed SPP SPP and status has not been verified

No	No. SPP	Tgl. Penyajian	Otorisasi Pimpinan	Status SPP	Menu
1	1/SPP/02.01/17/02/2017	17-02-2017	Sudah di-otorisasi	Belum diverifikasi	Verifikasi

Figure 11.

To verify the SPP, click the button next verification shown a list of activities that are already in-spp right. To perform the verification click “setuju”:

Figure 12a.

No	No. SPM	No. SPP	Tgl. Penyajian	Status SPM	Status Approval	Menu
1	1/SPM/02.01/17/02/2017	1/SPP/02.01/17/02/2017	17-02-2017	Belum diproses	KEUANGAN YAYASAN PENGELOLA YAYASAN	

Figure 12b.

Once clicked agree then displayed listing the SPM otorisator not approve. To authorize the SPM log in using a password and will be given facilities otorisator following menu

Daftar SPP

No	No. SPM	No. SPP	Tgl. Penyajian	Status SPM	Status Approval		Menu
					KEUANGAN YAYASAN	PENGELOLA YAYASAN	
1	1/SPM/02.01/17/02/2017	1/SPP/02.01/17/02/2017	17-02-2017	Belum diproses	Disetujui		Otorisasi

Figure 13a.

SETUJU DITOLAK

Surat Permintaan Pembayaran (SPP)

Nomor	Tanggal Perbaikan	Tahun Anggaran	Link Kerja
1/SPP/02.01/17/02/2017	17-02-2017	2017	SD PUSANTARA

No	Kode MAK	Nama Kegiatan	Anggaran	Anggaran yg pernah diterima	Anggaran yg tersedia	Anggaran yg diminta	Sisa Anggaran
1	11034	Rapat Bilang Kerkuliah	500.000	0	500.000	500.000	0
TOTAL						500.000	

Kelnes 17-02-2017
SD NUSANTARA

Ajukan Surat Permintaan Pembayaran (SPP) kami buat sesuai dengan dokumen perencanaan dan anggaran. Setelah data kami terima, akan kami proses sesuai dengan persetujuan dan akan kami pertanggungjawabkan legal validasi sesuai dengan aturan yang berlaku.

Figure 13b.

Further shown SPP is ready to be authorized, to approve click the “Setuju” button. After clicking “setuju” button will display “SPM” which was authorized by otorisator, meaning that the budget disbursement process has been completed. When the disbursement has been completed it will produce a document that is already authorized “SPM” authorities as follows

Daftar SPM

No	No. SPM	No. SPP	Tgl. Penyajian	Status SPM	Status Approval		Proses
					KEUANGAN YAYASAN	PENGELOLA YAYASAN	
1	1/SPM/02.01/17/02/2017	1/SPP/02.01/17/02/2017	17-02-2017	Disetujui	Disetujui	Disetujui	Cetak

Figure 14a.

Surat Permintaan Pembayaran (SPP)

Nomor SPP	Tanggal Perbaikan	Tahun Anggaran	Link Kerja
1/SPM/02.01/17/02/2017	17-02-2017	2017	SD NUSANTARA

No	Kode MAK	Nama Kegiatan	Anggaran yg diminta
1	11034	Rapat Bilang Kerkuliah	500.000
TOTAL			500.000

Kelnes 17-02-2017
SD NUSANTARA

Ajukan Surat Permintaan Pembayaran (SPP) kami buat sesuai dengan dokumen perencanaan dan anggaran. Setelah data kami terima, akan kami proses sesuai dengan persetujuan dan akan kami pertanggungjawabkan legal validasi sesuai dengan aturan yang berlaku.

KEUANGAN YAYASAN: [Signature]
PENGELOLA YAYASAN: [Signature]

Figure 14b.

The next step is the transfer of funds by the treasurer / love school, in these applications has prepared the following menu. In the column menu there is a choice of cash, cash-click the selection, it will be prepared receipt (Receipt Cashier / STTK) like to see the following:



No	NO. SPM	Nama Unit Kerja	Tanggal SPM Disetujui	Jumlah Yang Dibayarkan (Rp)	Menu
1	1/SPM/02.01/17/02/2017	SD Nusantara	17 Feb 2017	500.000	Tonal Rekening Lihat

Figure 15a.

No	Mudah Sub Unit	Nama Sub Unit	Kode BSK	Nama Kegiatan	Anggaran yg diinput
1	02/01	SD Nusantara	1834	Rapat Bidang Kurikulum	500.000
TOTAL					500.000

Figure 15b.

Financial Accounting for School

The menu consists of budget based accounting and non-budget based accounting as shown below:

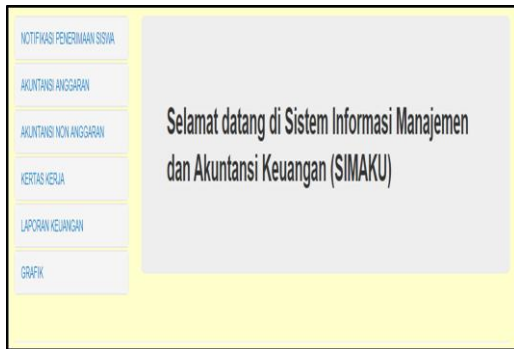

Figure 16a.

No	No. STTK	No. SPM	MAK	Nama Kegiatan	Realisasi SPM	Unit Kerja	Menu
1	1	1/SPM/02.01/17/02/2017	11104	Rapat Bidang Kurikulum	500.000	SD Nusantara	Jumlahkan

Figure 16b.

For the recording of cash receipts and actual realization of the budget we can use the facilities like in figure 17a and 17b below:

No	MAK	Nama Kegiatan	Unit Kerja														
1	1 1 1 01	Kegiatan Belajar Mengajar (KBM)	Pengelola Yayasan														
<table border="1"> <thead> <tr> <th>No</th> <th>Kode Rekening</th> <th>Nama Rekening</th> <th>Uraian</th> <th>Anggaran</th> <th>Realisasi</th> <th>Menu</th> </tr> </thead> <tbody> <tr> <td>1</td> <td>411101</td> <td>Penerimaan SPP</td> <td>sumber pendapatan</td> <td>1.000.000.000</td> <td>0</td> <td>Kas Unit Kas Yayasan</td> </tr> </tbody> </table>				No	Kode Rekening	Nama Rekening	Uraian	Anggaran	Realisasi	Menu	1	411101	Penerimaan SPP	sumber pendapatan	1.000.000.000	0	Kas Unit Kas Yayasan
No	Kode Rekening	Nama Rekening	Uraian	Anggaran	Realisasi	Menu											
1	411101	Penerimaan SPP	sumber pendapatan	1.000.000.000	0	Kas Unit Kas Yayasan											
2	1 1 1 01	Kegiatan Belajar Mengajar (KBM)	Pengelola Yayasan														
<table border="1"> <thead> <tr> <th>No</th> <th>Kode Rekening</th> <th>Nama Rekening</th> <th>Uraian</th> <th>Anggaran</th> <th>Realisasi</th> <th>Menu</th> </tr> </thead> <tbody> <tr> <td>1</td> <td>411101</td> <td>Penerimaan SPP</td> <td>sumber pendapatan</td> <td>500.000.000</td> <td>0</td> <td>Kas Unit Kas Yayasan</td> </tr> </tbody> </table>				No	Kode Rekening	Nama Rekening	Uraian	Anggaran	Realisasi	Menu	1	411101	Penerimaan SPP	sumber pendapatan	500.000.000	0	Kas Unit Kas Yayasan
No	Kode Rekening	Nama Rekening	Uraian	Anggaran	Realisasi	Menu											
1	411101	Penerimaan SPP	sumber pendapatan	500.000.000	0	Kas Unit Kas Yayasan											

Figure 17a.

No	No. SPM	MAK	Nama Kegiatan	Kode Rekening	Nama Rekening	Uraian	Anggaran	Realisasi	Unit Kerja	Menu
1	1/SPM/02.01/17/02/2017	11104	Rapat Bidang Kurikulum	5 2 8 1 1	makan/minum rapat	makan besar	262.500	0	SD Nusantara	Kas Unit Kas Yayasan
2	1/SPM/02.01/17/02/2017	11104	Rapat Bidang Kurikulum	5 2 1 1 0	Biaya ATK rapat	FC meteri	125.000	0	SD Nusantara	Kas Unit Kas Yayasan
3	1/SPM/02.01/17/02/2017	11104	Rapat Bidang Kurikulum	5 2 8 1 1	makan/minum rapat	snack	200.000	0	SD Nusantara	Kas Unit Kas Yayasan

Figure 17b.

For recording the non budget transactions, we can use the general journal as below:



INPUT JURNAL UMUM

Besar Nominal (dalam rupiah):

Uraian:

Nama Rekening yang di-DEBIT:

Nama Rekening yang di-KREDIT:

Tanggal Transaksi :

Unit Kerja:

JURNALKAN

Figure 18.

To check the ledger, click the “buku besar” button and to check the balance list, click the “neraca saldo” button, and the report can be shown as below:

To view budget realization report, click the “Realisasi Anggaran” button”, and the report can be shown:

LAPORAN REALISASI ANGGARAN BERBASIS FUNGSI									
GABUNGAN		UNIT							
BERBASIS SIFAT									
No	MAK	Nama Kegiatan	Unit Kerja	Anggaran		Realisasi		Selisih	
				Pendapatan	Belanja	Pendapatan	Belanja	Pendapatan	Belanja
1	11101	Kegiatan Belajar Mengajar (KEM)	Pengelola Yayasan	1.000.000.000	0	100.000.000	0	900.000.000	0
2	11101	Kegiatan Belajar Mengajar (KEM)	Pengelola Yayasan	500.000.000	0	200.000.000	0	300.000.000	0
3	11104	Rapat Bidang Kurikulum	SD Nusantara	0	587.500	0	100.000	0	487.500

Figure 20a.

LAPORAN REALISASI ANGGARAN BERBASIS SIFAT									
GABUNGAN		UNIT							
BERBASIS SIFAT vs. UNIT KERJA									
No	Kode Rekening	Nama Rekening	Unit Kerja	Anggaran		Realisasi		Selisih	
				Pendapatan	Belanja	Pendapatan	Belanja	Pendapatan	Belanja
1	411101	Penetnmaan SPP	Pengelola Yayasan	1.500.000.000	0	300.000.000	0	1.200.000.000	0
2	521101	Biaya ATK	SD Nusantara	0	125.000	0	0	0	125.000
3	528111	makan/minum rapat	SD Nusantara	0	462.500	0	100.000	0	362.500

Figure 20b.



Financial reports that can be generated from SIMAKU accordance with PSAK 45 is the Activity Report (figure 21a), Statement of Changes in Net Assets (figure 21b), and the balance sheet (figure 21c) as shown below:

LAPORAN AKTIVITAS TAHUN 2017

LAP AKTIVITAS vs. UNIT

PENERIMAAN

No	Kode Rekening	Nama Rekening	Saldo
1	41110	Penerimaan DPP	300.000.000
2	41210	Penerimaan Kerjasama Yayasan	0
3	41310	Penerimaan Transaksi Unit (yang Dianggarkan)	0
4	41320	Penerimaan Utasuda	0
5	41410	Penerimaan Dana Bos	0
6	42110	Penerimaan unit pelayanan yayasan	0
7	42210	Penerimaan kerjasama yayasan	0
8	42310	Penerimaan jasa bank	0
9	42320	Penerimaan Bagi-hasil	0
TOTAL PENERIMAAN			300.000.000

BELANJA

No	Kode Rekening	Nama Rekening	Saldo
1	51110	Gaji pegawai	0
2	51121	Tunjangan	0
3	51122	Tiuk	0
4	51130	Insentif dan bonus	0
5	51140	uang lembur	0

Figure 21a.

LAPORAN PERUBAHAN AKTIVA BERSIH TAHUN 2017

GABUNGAN UNIT

AWAL TAHUN ANGGARAN 2017/2018

No	Kode Rekening	Nama Rekening	SALDO
1	311	Aktiva Bersih Tidak Tertikat	0
2	321	Aktiva Bersih Tertikat Temporer	0
3	331	Aktiva Bersih Tertikat Permanen	0
EKUITAS AWAL			0
SURPLUS			297.900.000

AKHIR TAHUN ANGGARAN 2017/2018

No	Kode Rekening	Nama Rekening	SALDO
1	311	Aktiva Bersih Tidak Tertikat	297.900.000
2	321	Aktiva Bersih Tertikat Temporer	0
3	331	Aktiva Bersih Tertikat Permanen	0
EKUITAS AKHIR			297.900.000

Figure 21b.

simaku

REKAPITULASI TAHUN 2017

No	Kode Rekening	Nama Rekening	Saldo
1	1111	Kas dan setara kas	1.900.000
2	112	Piutang	0
3	113	Perdagangan/ATK	0
4	121	Tanah	0
5	122	Bangunan, sarana dan prasarana umum	0
6	123	Sarana ibadah	0
7	124	Peralatan kantor, pelayanan dan promosi	0
8	125	Kendaraan bermotor	0
9	131	Akumulasi penyusutan bangunan, sarana dan prasarana umum	0
10	132	Akumulasi penyusutan sarana ibadah	0
11	133	Akumulasi penyusutan peralatan kantor, pelayanan & promosi	0
12	134	Akumulasi penyusutan kendaraan bermotor	0
13	141	Utuk	0

Figure 21c.

CONCLUSION

There are two important aspects of the governance of the organization, namely the management concept and governance concept. Governance is value that must be embedded in the concept of management in order to create good management. Those values include transparency, accountability, responsibility, independence, and fairness. In managing educational organizations at this context is the school, good governance and good management must be realized properly. To support the achievement those two concept, IT becomes a key achievement of effectiveness and efficiency, transparency and accountability

in financial management. SIMAKU for school can be the IT alternative instrument in achieving good school governance.

REFERENCES

- Donaldson, L. & Davis, J.H., (1991). Stewardship Theory or Agency Theory: CEO Governance and Shareholder Returns. *Australian Journal of Management*, 16, 49
- Eko Raharjo, *Jurnal Ekonomi*, (1 Juni 2007). Teori agensi dan teori stewardship dalam perspektif akuntansi, vol 2, no 1
- [Http://www.pikiran-rakyat.com/pendidikan/2016/06/18/peringkat-pendidikan-indonesia-masih-rendah-372187](http://www.pikiran-rakyat.com/pendidikan/2016/06/18/peringkat-pendidikan-indonesia-masih-rendah-372187)
- James H. Davis, F. David Scoorman dan Lex Donalson. (1997). *“Toward a Stewardship Theory of Management.” Academy of Management Review* Vol. 22, No. 1, page 22-47, 1997
- Lubis, SM. Hari & Huseini, Martani (1987). *Teori Organisasi: Suatu Pendekatan Makro*, Jakarta: Pusat anrat Universitas Ilmu-ilmu Sosial
- Mardiasmo. (2002). *Akuntansi Sektor Publik*. Penerbit Andi. Yogyakarta
- Republik Indonesia, (2003). *Undang-Undang Republik Indonesia no 20 tahun 2003 tentang Sistem Pendidikan Nasional*
- Suryo, Pratolo. (2014). *Good Corporate Governance: Implementasi pada BUMN di Indonesia*, ISBN: 978-602-7577-459, Penerbit:LP3M UMY, Januari 2014



**THE ROLES OF GOOGLE GIFT CARD AND GOOGLE WALLET IN
ACCOUNTING AND BUSINESS**

Ilyas Fachrurazi

Wierdina Carmel Prasetyo

Aemilius Dyarma Satria

Accounting Department Undergraduate Students

Faculty of Economics Parahyangan Catholic University

Bandung - Indonesia

ilyas.fach@gmail.com

Abstract

The main purposes of this paper are to explain the business process that occurs in Google Gift Card and Google Wallet; the accounting treatment for the type of transactions, the issues that are related to the transaction in Google Play Store, in-app purchase and the use of Google Gift Card, and the effects of Google Gift Card and Google Wallet in business process. We do the library research in order to achieve the objective of this study. Google Gift Card is a Business-to-Consumer e-Commerce model based on online transaction process system. The balance of Google Gift Card itself is integrated with Google Wallet. Accounting treatment for Google's revenue from Google Gift Card refers to IFRS 15 according to Ernst & Young's and Deloitte guidelines; PSAK 23 according to Indonesia's statement of financial accounting standards. The issues that occur related the use of Google Gift Card are overbilling, age restriction, overpricing, tax, and accounting issues for seller. Besides of those issues, Google Gift Card is one of the new methods that provides convenience in making payment.

Keywords : Google Gift Card, Google Wallet, issues, accounting, IFRS, PSAK.

JEL Classification: M15, Q55



INTRODUCTION

Because of the development of technology, business will grow rapidly developed. In the present application of this developing industry, especially for smartphone platform, Android based on Open Source makes the application developers compete to make application compatible with Android because Android gives easiness to disseminate his application.

Since February 2014, in Indonesia officially Google has provided the services that developers application be able to sell his application in Playstore as well as sell goods in-app purchases. The developers application in Indonesia became more motivate to continue working, but also they could get income of the application they had made.

At the beginning of 2016, Google officially introduced Google Gift Card for the Indonesian region. This increased the developers and the communities motivation because it would be give the ease transaction and especially in Google Play Store and better income.

The writer are interested in this topic, especially for the young people who spend the money for purchasing virtual goods in game. It is interesting to know the process of the transaction between the buyers and Google, the accounting treatment as well. As they will be affected by this kind of business model.

LITERATURE STUDY

The Transaction Processing Cycle

Transaction processing system capture and process data describing business transactions, update organizational databases, and produce a variety of information products (O'Brien & Marakas, 2009).

1. Data Entry

The first step of the transaction processing cycle is the capture of business data. For example, transaction data may be collected by point-of-sale terminals using optical scanning of bar codes and credit card readers at a retail store or other business. Transaction data can be captured at an e-commerce Website on the Internet.



2. Transaction Processing

Transaction processing systems process data is divided into: (1) **batch processing**, where transaction data are accumulated over a period of time and are processed periodically, and (2) **real-time processing**, where data are processed immediately after a transaction occurs.

3. Database Maintenance

Organization's databases must be updated by its transaction processing systems so that they are always correct and up-to-date. Therefore, transaction processing systems serve to assist in maintaining the corporate databases of an organization and to reflect changes resulting from day-to-day business transactions.

4. Document and Report Generation

Transaction processing systems produce a variety of documents and reports. Transaction reports might take the form of a transaction listing such as a payroll register, or edit reports that describe errors detected during the processing.

5. Inquiry Processing

Many transaction processing systems allow to use the Internet, intranets, extranets, and Web browsers or database management query languages to make inquiries and receive responses concerning the results of transaction processing activity.

Business to Consumer (B2C)

Business to Consumer (B2C) is the kind of buying and selling of products involving companies the seller and the end of consumers taken all of a electronic (O'Brien & Marakas, 2009). Characteristic of B2C E-commerce is to open to the public, where information distributed to public. Service is generally given in nature (generic) with a mechanism that can be used by their common people. For example, because of Web systems common use and service given with Web-based, service is given based on the request (on demand). Consumers do the initiative and providers of services or goods should be ready to respond according to the request. Client or Server Approach is often used where taken the assumption client



(consumer) utilizes this system minimal (Web-based) and the processing (business procedure) is laid out at the sides server.

NFC Technology

As in modern computers and interfaces, increasing mobility of computing devices provided by mobile communications is also an important step in the development of NFC. Near-Field Communications (NFC) is a short-range high frequency wireless communication technology that enables the exchange of data between devices over about a 10 centimeters distance (Coskun, Ok, & Ozdenizci, 2013). The main vision of NFC is the integration of personal and private information, such as credit card or cash card data into the mobile phones. NFC is an upgrade of the existing proximity card standard (RFID) that combines the interface of a smartcard and a reader into a single device. It allows the users to seamlessly share content between digital devices, to pay bills wirelessly or even to use their cellphone as an electronic traveling ticket on existing contactless infrastructure which has been use for public transportation.

The significant advantage of NFC over Bluetooth is the shorter set-up time. Instead of performing manual configurations to identify Bluetooth devices, the connection between two NFC devices is established at once (under a 1/10 second). Due to its shorter range, NFC provides a higher degree of security than Bluetooth and makes NFC suitable for crowded areas where correlate a signal with its transmitting physical device (and by extension). Its user might otherwise prove impossibility. NFC can also work when one of the devices is not powered by a battery (e.g. on a phone that may be turned off, a contactless smart credit card, etc.).

Google Gift Card

Google Gift Card is one of a payment method used to purchase an application or services that is in Google Play Store. In Indonesia, before Google Gift Card comes and becomes one of alternatives payment method, purchases an application and in-app purchase can only be made with credit card and carrier mobile's balances. In Indonesia, Google Gift



Card officially introduced in early 2016 and it can be purchased in the local convenience store called Indomaret with the amount of Rp150.000, Rp300.000, and Rp500.000.

Google Wallet

Google Wallet is a peer-to-peer payments service developed by Google that allows people to send and to receive money from a mobile device or desktop computer at no cost to either a sender or a receiver (Handa, Maheshwari, & Saraf, 2011). The applications is available for devices running minimum Android 4.0 and for iOS devices running iOS 7.0. Google Wallet itself still developed by Google and has not been operated completely yet in whole world. In Indonesia, Google Wallet can be used as a tool to view detail of our previous transaction on Google Play Store and in-app purchases, and to transfer money to the bank.

RESEARCH METODOLOGY

Descriptive study is the purpose of the study that we used in this research. Descriptive study is often designed to collect data that describe characteristics of people, events, or situation (Sekaran & Bougie, 2013). We describe the advantages as well as the disadvantages of using Google Products generally. Google Products that will be discussed are Google Gift Card and Google Wallet. Those two products of Google are the object of our study. We will discuss more about the advantages of Google Gift Card and Google Wallet in accounting and business specifically.

In doing this research, we did library research as the data collection technique. The data that we used were secondary data. The data of this study were obtained from various sources that had already existed. We used scientific journals, textbooks, and websites that conducted to our current study.

DISCUSSION AND RESULT

Online Transaction Process System

Transaction of buying an app in Google Play Store or purchase virtual goods that exists within an application (in-app purchase) uses a real-time system to capture and to



processed transaction on the spot. Some basic activities related to the transaction processing cycles are Data Entry, Transaction Processing (in this case the real-time processing), Database Maintenance, Document and Report Generation, and Inquiry Processing.

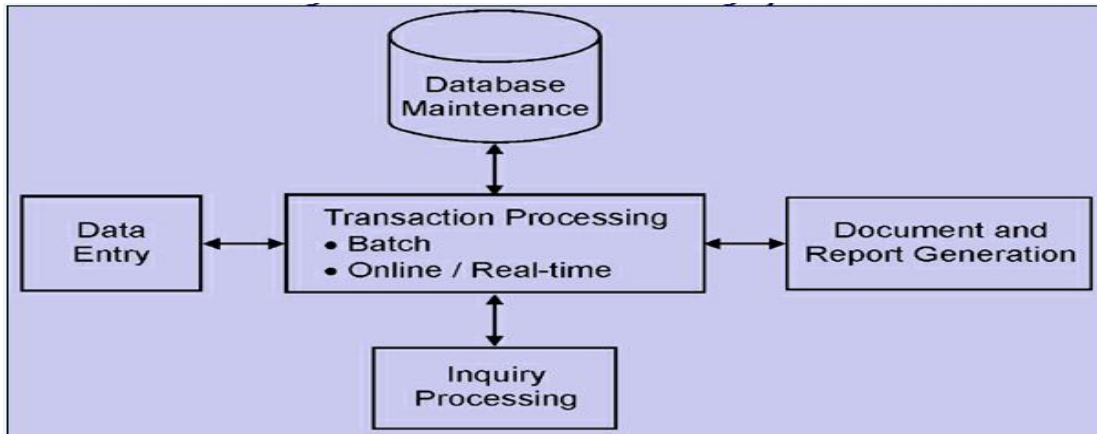

Figure 1. Transaction Processing Cycle

Source: <http://www.expertsmind.com/>

Business to Consumer (B2C) e-Commerce & Payment System

In this type of transaction, we can put Google Play Store in either of two sides of business process. One is when we buy an application in Google Play Store, Google Play Store provides a place to make the developer of the application and the buyer meet. The other one is when we buy virtual goods inside an application (in-app purchase), Google Play Store makes itself as third party payment service provider (in this case by using Google Gift Card).

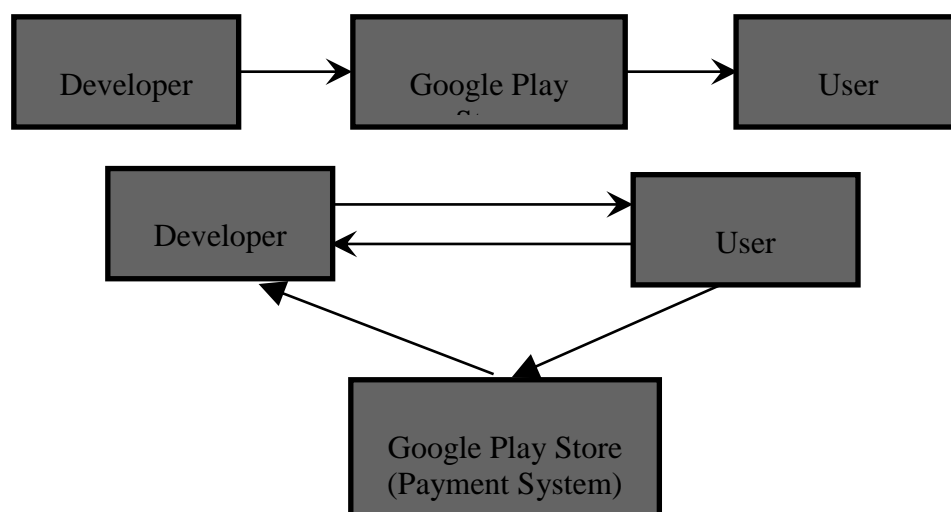

Figure 2. Difference Function of Google Play Store

Source: Writer

Business Process in Google Play Store

To be one of seller in Google Play Store, first step we should register as a developer in the Google Play Developer Console and should pay the registration fee of 25 USD via Credit Card. After this step actually we can publish our application but the application that we release only can be categorized as free application. We have to register as a merchant in Google Wallet in order to release the paid content. After that we can upload the apk. files and in Google Play Developer Console we can arrange all the prices about our application and products inside the application. Google Play Store sets a condition in determining the price. Google Play Store will take 30% of the price we set as a transaction and operational cost in each transaction we make.

Accounting Policy about Digital Payment

Based on the guidelines issued by Ernst & Young, accounting treatment of revenue related with the technology, was written in IFRS 15 on Revenue from Contracts with Customers. This standard is not specific to mobile application transaction. A customer here can focus more on business to business transaction, and the discussion about the contract, the implementation of the bonds in the contract, the determining the transaction price, the

allocation to the transaction price, the recognition of revenues, and the general things that applicable in all entities.

Meanwhile, Deloitte as one public accounting firm that audited several enterprise application developers issued guidelines based on IFRS 15 together with more detail explanation of the digital goods which explains the eligible criteria of goods or services as digital goods, and the debt instruments on the voucher as well. As for Indonesian Standards (PSAK), the closest one is PSAK 23 regarding revenues, but there is no specific section that explains the digital payment transaction activities.

Issues related Google Gift Card

This section are a few of issues that are related transaction in Google Play Store, in-app purchase and the use of Google Gift Card :

1. Overbilling

Before Google Gift Card came, payment which was related to Google Play Store had been made by Credit Card. This became a problem in society when consumption was not limited, this might increase billing of the credit card to become unpredictable amount and high for some people.

Then Google implements another payment method for purchasing application and other virtual goods with balance of mobile carrier. The overbilling problem with this new method for some people was solved, but for people who uses post-paid method for their carrier mobile billing the overbilling still become one of their issues. And then Google Gift Card launched easier and more secure method because it's integrated with Google itself and can solve the overbilling issues.

2. Age Restriction

The lack of Google Play Store is inappropriate for under-age because the content may contain violence. Previously, the control of age of the user who purchase, can be controlled because they must use credit card to make their own purchases. But when Google Gift Card was introduced to the user, this issue comes up because a lot of under-age can access the Google Gift Wallet easily in local convenience



store. Overbilling issue may be solved with Google Gift Card but this Age Restriction issue comes up.

3. Overpricing

For some people especially in Indonesia the price that set by Google Gift Card may be too high. Meanwhile, the price of the application is lower than the minimum amount offered by Google Gift Card and making a lot of balance remain worthless.

4. Tax

With this new method many people especially in Indonesia about the tax. When mobile carrier balance can be used as one of the payment method all of prices in Google Play Store and virtual goods, which are set before value-added tax, so at the end they charge more than the prices that are displayed.

After Google Gift Card become one of the payment method, value added tax has already applied when people buy the gift card from convenience store. So when people buy application or virtual goods, they will pay exactly the same amount which is displayed on their phones.

In few countries that apply tax sales, Google automatically takes the tax sales from the prices offered by developer. So at the end the developer will get 70% minus tax sales that is applied in each country.

Meanwhile, in Indonesia tax sales are not described full details. On Google's website, Indonesia is not one of the countries which is included in the automatic tax sales system.

5. Accounting Issue for Sales

There's no specific standard that describes about how accounting principles should be applied for this type of transaction. Lot of problems happen especially how to manage the cash flow, and how to measure the income and the profit because some aspects like overhead cost can't be measured easily.



Effect of Google Gift Card and Google Wallet in Business Process

This new method of business can motivate the developers and the business users. They should be creative and should participate in this business type. Terms and requirements are easily can be considered from so many applications in Google Play Store now.

Other than applications, Google Play Store now gives the access to people to subscribe magazines, to buy books and films. This is an opportunity for people to participate.

Applications of Google Gift Card are mainly to do transaction inside Google Play Store easier. In the future Google Wallet will affect business process significantly because it can be used to buy various goods in convenience store.

In America and Britain, using Google Wallet as a payment instrument need some requirements. One is a device. The device which can be used as a tool is a device that has NFC technology and is already integrated and approved by Google.

Until now, only Nexus 5 and Nexus 6 that can be used as means of payment google wallet, although some other devices have already had NFC technology, but Google has not verified it yet, so other devices will fail when they try to use Google Wallet.

On the other hand, the store must have a tool that can get the payment of authorized use google wallet. In America and Britain, not all stores have these devices, so that it is necessary to adapt and to adjust if the store wants to use this technology.

These things are the business challenges in the future, especially if Indonesia wants to implement it. Smartphone vendors will try to meet the requirements for technology (in this case the NFC) and to receive the approval from google so that the device they have made can be used for Google Wallet. On the other hand, the stores and other businesses must provide the tools whereby Google Wallet can be used in their shops.

However, the most difficult is to change Indonesian people's habits. Payment methods like this is a new thing. Although impressed by the high-tech, but if the people themselves are not ready to implement the method like this, it will not run properly and effectively in line with expectations of the company.

On the other hand for accountants, this field is a new field, there is no specific standard that describes the accounting treatment for these types of transactions like this.



Some websites provide accounting services for e-commerce and it is an opportunity for accountants to work in this field.

CONCLUSION

Conclusion

Use of Google Gift Card as one of the new methods of making payments makes people easy to make the payment. This is an opportunity for developers and businesses to take the plunge and sell its products in the Google Play Store. However, it must still be considered the issues that will arise after applying this method. Especially in the field of accounting because there is no specific standards about regulating this issue.

Recommendation

Google Gift Card and especially Google Wallet are believed in the future will be implemented in Indonesia even though according to the author, it is not in a short time. However, the businesses should be aware of this new payment technology quick adaptation and adjustment when the technology is finally implemented. Adequate preparation will be required when this kind of technology applies in Indonesia. So every people will be ready when it happens.

REFERENCES

- Coskun, V., Ok, K., & Ozdenizci, B. (2013). *Professional NFC Application Development for Android*. New Jersey: John Wiley & Sons.
- Deloitte. (2015). *IFRS 15 Revenue from Contracts with Customers YOUR QUESTIONS ANSWERED*. CPA Canada.
- Deloitte. (2015). *Media & Entertainment Spotlight Navigating the New Revenue Standard*. Deloitte.
- Ernst & Young. (2015). *The New Revenue Recognition Standard - Software and Cloud Services*. Ernst & Young.



Handa, R., Maheshwari, K., & Saraf, M. (2011). *Google Wallet - a Glimpse Into the Future of Mobile Payments*. Norderstedt: GRIN Verlag

O'Brien, J. A., & Marakas, G. M. (2009). *Management Information System*. McGraw Hill

Sekaran, U., & Bougie, R. (2013). *Research Methods for Business A Skill-Building Approach 6th Edition*. Southern Gate: John Wiley & Sons.



**THE ROLE OF XBRL USE TO THE QUALITY OF ELECTRONIC FINANCIAL
STATEMENTS AND COMPANIES RISK**

Teja Jatmika

Accounting Department Undergraduate Student
Faculty of Economics, Parahyangan Catholic University
teja.jatmika@gmail.com

Abstract

XBRL is now widely known by entities that are in Indonesia in particular that have been incorporated by the Indonesia Stock Exchange. The emergence of XBRL itself is based on the need for a language that can synergy financial statements that have been made by the company into a format that can be processed easily and can be understood by all aspects at the same time. Financial reporting becomes very important here because in the era of interconnecting these state borders in the economic barrier less visible, and this may be an opportunity for a country to attract foreign investors with financial reporting both reflecting the economic value of a company. It is expected also of good reporting and XBRL format companies in all area ready to respond to risks that may threat the company in achieving its goals.

Keywords: *eXtensible Business Reporting Language (XBRL), Financial Statements, Risk*

JEL Classifications: *M15, Q55, D80*

INTRODUCTION

Accounting is the systematic and comprehensive recording of financial transactions pertaining to a business, and it also refers to the process of summarizing, analyzing and reporting these transactions to oversight agencies and tax collection entities. Accounting is a factor that can be used in a business system to be able to determine a good decision to be implemented by the company in achieving its goals. Any business process in his transaction requires a transaction record which is the main ingredient for making a financial statement to be a reflection of the company's performance during a certain period. To support the



uniformity of the International Accounting Standards Board (IASB) published International Financial Reporting Standards (IFRS), which are international accounting standards that guide internationally. IFRS become a basis for accounting standards of a country that has a framework which is not dissimilar and had the same treatment.

The development of technology has brought almost all aspects of human life to computerized stages which are reflected by technology has been applied in the process of the company's operations with not the exception of accounting ie financial reporting. Developments in technology now become an obligation that must be followed by a company to remain competitive in the business, because almost all aspects of human life have been dominated by the use of technology. XML was originally used as the format for the language of the internet is considered not to facilitate the needs of the financial statements on the Internet which requires data to be processed further. For that reason, XML was developed with a focus on the financial statements and the business into a new programming language is eXtensible Business Reporting Language (XBRL).

The use of XBRL in the accounting area can help companies make electronic financial reporting, action plans and risk assessments that will be a decision of a work plan to support the company in achieving its goals. By implementing the use of XBRL in financial reporting company can cut the work which is manual data input. It can be an advantage because the company can allocate labor to the sector or the more important work and work effectively. Not only that, the use of XBRL in the company can become a cornerstone of the company to determine the company's risk coming period with predictions based on previous periods as well as a sharp analysis and share information more easily processed by a subsidiary of the company with more complexity.

LITERATURE REVIEWS AND RESEARCH QUESTION

Risk Assessment

Risk Assessment is a component of the COSO ERM identifying occurrences in several ways; possibilities, both positive and negative impact, is based on the individuals and categories, their effects on other units in the organization, and inherent or residual risk.



Inherent risk is the inherent hazards before implementing management control of the likelihood or impact of a risk. Residual risk is the risk that remains after management implementing internal control or a response will be to the risk. Of the existing risk assessment and then management can respond in four ways, that is (Romney & Steinbart, 2012):

1. Reduce. Reduce the likelihood and impact of a risk with the implementation of an effective system of internal control.
2. Accept. Receiving the likelihood and impact of risks.
3. Share. Share the risk or transfer risk to an entity such as buying insurance, outsource, or conduct transactions with the agreement.
4. Avoid. Avoiding the risk of not doing the activity that gives rise to the risk.

Risk Assessment has the following objectives (Romney & Steinbart, 2012):

1. Help accountants and systems designers create effective design of the control system to reduce inherent risk.
2. Evaluate the internal control system of controls to ensure that operations have been carried out effectively.
3. Assess and reduce the inherent risk using risk assessment and strategy to respond.

The main types of risks that may arise in a business which, despite being divided but such risks are still in contact, that is (Blackman, 2016):

1. Strategic Risk: The risk of where the company's strategy to be less effective and the company strive to achieve as a result.
2. Compliance Risk: The risk that refers to the applicable laws and regulations have been implemented company or not and also whether the company has always followed the developments and changes in laws and regulations.
3. Operational Risk: The risk of internal refers to an unexpected failure in the company's daily operations.
4. Financial Risk: The risk that refer specifically to the inflows and outflows of money in the company and will likely financial losses.
5. Reputational risk: Risk refers to the company's reputation, brand awareness of consumers for goods and services as well as the viewpoint of the public on the company as a whole.



Extensible Business Reporting Language (XBRL) Definition's

Extensible Business Reporting Language (hereinafter referred to XBRL) (Philips, Bahmanziari, & Colvard, 2016) is a reworking of how we deploy and use the data in the business. XBRL (Romney & Steinbart, 2012) is a programming language that is designed specifically to facilitate the communication of business information. According to the above two definitions can be defined as the XBRL reporting language based on XML that was developed with the aim of facilitating communication and procedures for the use of the data used in the business. XML (W3C, 2016) itself is a simple text-based format for representing structured information: documents, data, configuration, books, transactions, invoices, and more. XBRL can overcome the current financial reporting issues related to transparency, efficiency and accuracy are also facilitate the company's efforts to achieve legislative compliance cost. Without XBRL, an electronic document reporting only a digital version. Humans can read the data, but the computer will not be able to process unless the data manually inputted in a certain format. XBRL has four essential components to be able to understand the use of XBRL in the reporting process and produce a guarantee, that is (Venkatesh & Armitage, 2012):

1. XBRL specification: provides the framework and terms required for using XML technology to create XBRL taxonomies and XBRL instance document, the specification describes the technical details explaining how XBRL works and can not be edited by the user.
2. Taxonomy: a dictionary that describes the main data element (number or text) to create documents such as for certain types of financial reporting or business.
3. Instance document: computer-readable document that consists of a collection of command data in accordance with concepts found in the taxonomy used.
4. Style sheet: it is required to make the data in the raw XBRL instance document to be read by many people by word, pdf or spreadsheet format.

Benefits eXtensible Business Reporting Language (XBRL)

XBRL benefits are (Indonesia Stock Exchange Bursa Efek Indonesia, 2016):

1. Increase the usefulness of electronic reporting system for implementing:



- a. The format that has been standardized, so as to produce the information and data that can be compared and easy to analyze.
- b. Validation automatically, so as to minimize input errors.
2. Facilitate does publication of the report (including financial statements) for XBRL can be recycled into the desired format.
3. Improve the accessibility of financial information, particularly for international investors, because XBRL applying a standard of identification information.
4. The benefits seen on automation, cost savings, faster, more reliable and more accurate handling of data, analysis of improvement and a better quality of information and decision-making and accelerate business decision making for investors.
5. XBRL format that is useful to report the BEI to the development of Business Intelligence that will be used for the evaluation and monitoring of listed companies.

RESULT AND DISCUSSION

The Role of XBRL Use to The Quality of Electronic Financial Statements and Companies Risk

Financial reporting is a factor that became the benchmark for all stakeholders in the decision making of a company, can also be a reference for decision-makers in the company in determining the measures taken and will impact on the relevant market which is a subsystem of the operating process. The financial statements also represent the economic value of a company to investors, so that the reporting should be easily accessed and processed. Along with the technological developments in the area of the internet, financial reporting began venturing into the digital world. The need for reliable financial reporting, integrated and easily accessible to users, both internal and external, become an obligation that must be meet by a company to be competitive in the present. Financial reporting subsequently began to turn into electronic documents but only in the type of documents rather than components of financial reporting. This becomes an obstacle for such documents can only be read by



humans but can not be read and processed again by the computer components. The level of errors caused by humans is still quite high and takes a fairly long process of having to perform manual input each period. XBRL be the answer to the needs of an integrated financial reporting and back of each component can be processed by computers not only be read by a human. XBRL by definition that has been described in the foregoing discussion was the development of the programming language (XML), which focuses on the financial reporting which follow the development of the Internet as well as business processes. For companies with many subsidiaries and using different programs in its financial reporting, XBRL can be a communicator between document because it can be converted into a variety of formats without having done manually input the data again and instantly be able to meet the standards that have been set.

Prior to the implementation of XBRL in Indonesia, financial reporting refers to the PSAK and IFRS. Financial reporting with reference to PSAK and IFRS actually meet the applicable standards in both the national and international coverage. However, to a format that can be used universally for unmet financial reporting was published in format word, pdf, spreadsheets or other formats which are mapped to a particular program. XBRL does not produce accounting standards but promoting the use of the standard itself . With the XBRL, can help accountants work as contained in the XBRL taxonomy that has followed the applicable standards and set internationally. XBRL itself is built based on the accounting standards apply uniformly and become a benchmark of any country accounting standards such as International Financial Reporting Standards (IFRS). XBRL financial reporting becomes easy to access either by accountants, managerial and other stakeholders. XBRL also assist companies in making financial reports are reliable because automation contained in XBRL has defined a working method that will reduce the likelihood of human error, which is a potential risk when making financial statements and accountant no longer preoccupied with the data input continuously because it has provided the format is fixed. But in the process of implementation, required migration from the old program data format to format the data in XBRL. In this phase will require more accuracy because of the possibility of human error during manual data input process can be increased. This can lead to extra costs because of the need for during the data migration process is necessary supervision and escort by the parties



understand more about XBRL. In Indonesia, XBRL began obliged to issues that have been incorporated in accordance with the needs of IDX. Another reason is that Indonesia's membership in the G20, which has a program application of XBRL in order to have a common understanding in its financial statements. With the implementation of XBRL can help the Indonesian economy by encouraging foreign investors to invest with ease will provide assessment and analysis of the company's assets in Indonesia in a format and language that matches the investor's home country.

Quality financial statements have four characteristics, that is understandable, relevant, reliability, and comparability. With the implementation of XBRL in a company can support the company's financial reporting achieve quality financial statements because it supports all four aspects. The financial reports considered good quality can also reduce the risks that may occur with the analysis of the work of a company that later revealed to be the basis of a risk assessment of the company's strategic risk. In the early adoption of XBRL in a company very likely increase, the financial risk to the company gets for the company to invest in XBRL technology. When the data migration process will require extra cost to implement the technology and training employees to use the XBRL. But the investment process XBRL in a company can not guarantee after application of the company will get the results that deserved because XBRL is only disclosed financial statements are in accordance with the applicable standards and services to be accessed by stakeholders, does not regulate the operation of companies that impact the company's business processes. However, if the company has been able to meet the financial statements that are integrated with XBRL will be able to raise the confidence of the company's corporate compliance because the XBRL has been set the tag and taxonomy adopted from the IFRS. It becomes a bargain for the company because the company has been able to give stakeholders confidence in its financial reporting. It explains that with the adoption of XBRL companies can reduce compliance risk and reputational risk directly with the issuance of financial statements with XBRL format. Operational risk is not included in the discussion of the application of XBRL in a company due to the application of XBRL does not directly affect the company's operations but rather to standard reporting, this also and stressed on the objectives the creation of XBRL that facilitate financial reporting for the business process instead of the company's operations.



CONCLUSIONS

The financial statements have standardized also can assist the management company in data processing that has happened and determine an accounting plan and the relevant decisions to be applied in the next period. With the use of XBRL management companies are permitted to be able to process the financial statements which have been provided to create a work plan with several options further. With the financial statements easily processed also can perform trace management in order to conduct a risk assessment to avoid the significant risk that the company may encounter the next period. The decision taken by the management would have some consideration of the risk assessment has been done and will impact on how the company plays an active role in the market which also supports the business activities of the company's business lines. The use of XBRL system also supports a business because of XBRL financial reports more easily accessible both by stakeholders and support the information exchange process becomes more transparent so as to determine a decision at a relatively cheaper and faster time in which stakeholders are entities of a business system,

The development of technology to support the development in the field of accounting in terms of reporting. With the widespread use of the Internet, it takes a standard in financial reporting are not only in the form of changing the format of the document but includes components that can also be accessed and processed by a computer directly from the financial statements will be published on the internet. XBRL is the answer to the standard requirements. With the adoption of XBRL in financial reporting processes of the company, financial statements of components can be processed directly by the computer, this is in addition to support ease of access to the financial statements may also support the quality of the financial statements as they may be free of human error. With the implementation of XBRL business, there are also risks in a company can be minimized because the management can easily process the data and format that they can understand so that they can perform their own risk analysis. Objectives of the development of XBRL also has clearly stated that XBRL is an XML-focused financial reporting and business processes.



REFERENCES

- Andika Januario, D. T. (n.d.). Analisis Penerapan XBRL Pada Standarisasi Penyajian Laporan Keuangan Industri Perbankan di Indonesia. 1-13.
- Blackman, A. (2016, November 30). Business: Risk Analysis. Retrieved from Envatotuts+: <https://business.tutsplus.com/id/tutorials/the-main-types-of-business-risk--cms-22693>
- Indonesia Stock Exchange Bursa Efek Indonesia. (2016, September 16). Beranda: Perusahaan Tercatat: XBRL: Tentang XBRL. Retrieved from IDX Web site: <http://www.idx.co.id/id-id/beranda/perusahaantercatat/xbrl/tentangxbrl.aspx>
- Nugroho, J. (2016, November 29). Ekonomi; BEI: Penerapan XBRL untuk Emiten Masih Dikaji. Retrieved from Sumbar Antaranews Web site: <http://sumbar.antaranews.com//berita/15476/bei-penerapan-xbrl-untuk-emiten-masih-dikaji.html>
- Philips, M. E., Bahmanziari, T. E., & Colvard, R. G. (2016, September 7). Feature: Business & Industry: Technology. Retrieved from Journal of Accountancy Web site: <http://www.journalofaccountancy.com/Issues/2008/Feb/SixStepstoXBRL.htm>
- Romney, M. B., & Steinbart, P. J. (2012). Accounting Information System. Essex: Pearson.
- Venkatesh, R., & Armitage, J. (2012). Accountants' Awareness and Perceptions About Assurance on XBRL Financial Statements. *The Journal of Applied Business Research* - March/April 2012.
- W3C. (2016, September 8). Standards: Web Design and Applications: XML Technology: XML Essentials. Retrieved from W3C Web site: <https://www.w3.org/standards/xml/core>



**ANALYZE TO THE ROLE EXTENSIBLE BUSINESS REPORTING LANGUAGE
(XBRL) TO IMPROVE THE ACCURACY OF TAX REPORT**

Patrick Naomi Maysias Simanjuntak

Accounting Department Undergraduate Student

Faculty of Economics

Parahyangan Catholic Univesity Bandung

patricknaomi.1995@gmail.com

Abstract

XBRL (eXtensible the Business Reporting Language) is an XML-based open standard that supports the modeling of information and expression of semantic meaning which is usually required by business reporting. XBRL uses XML syntax and XML-based technologies to explain the semantics. XBRL in the world of taxation will be implemented at the beginning or end of the year 2017. This XBRL would be equal with XBRL system by the Indonesia Stock Exchange. XBRL taxation will also be implemented on the use of online SPT, which is where this online SPT been carried out first. Expected tax authorities may socialize XBRL to the Indonesian company. From the study it can be concluded that, XBRL will facilitate the taxation of tax authorities to track companies that missed or delayed pay taxes to the State.

Keywords: eXtensible the Business Reporting Language

JEL Classifications: M15, Q55, H25

INTRODUCTION

Rapid changes in technology have affected human life. Like an internet, a computer network that has no central control or organization, which can be used for communication, research needs and also buying and selling goods and services. Currently we met accounting software is highly diverse, including Zahir, myob, accurate etc. In recent times AICPA're constantly working to develop the eXtensible Bussiness Reporting Language (XBRL) to replace the formal use of HTML.



XBRL began to grow in early 1990, XBRL made since the discovery of the weakness of HTML that is not able to explain the contents of the data presented. XBRL is first used for the financial statements of commercial and industrial establishments were compiled based on United States GAAP. Before XBRL used at the company made eXtensible Markup Language (XML). XML is not enough to be a general purpose language in communicating financial information. Ability thing necessary is to not only identify each piece of data, but how the data is processed and how it relates to other data.

In the world of accounting and business, financial reports is one measure that describes the extent to which the performance of a business. The financial statements can also be communicated to investors, creditors, management, and all those who use the financial statements about how the condition of a business. In addition, the financial statements are also an aspect to be considered for taking a good decision by the investors, creditors, and management. Thus, reporting of a financial statement is very important in the business world because it can communicate with any aspect of the business performance. In addition to financial reports, taxes reports are also one important aspect in the world of business and accounting. So between the financial statements and tax records is integral to the world of Accounting and Business.

The purposes of this study are explain the role of XBRL in the world of accounting and business, explain the role of XBRL in generating accurate tax reporting, and mention the benefits and usage in XBRL.

LIST REVIEW AND RESEARCH

Questions

There are many problems in this research, such as What are the role of XBRL in the world of accounting and business? What is the role of XBRL in generating accurate tax reporting ?, and What is the benefit and use of the XBRL ?.



eXtensible Business Reporting Language (XBRL)

According to (Romney, 2012) in his book Accounting Information Systems XBRL is a system of financial reporting standards in accordance with the respective companies and are not out of the concept of General Accepted Accounting Principles (GAAP). XBRL is defined as an XML-based open standard that supports the modeling of information and expression of semantic meaning which is usually required by business reporting. Communication concept that is applied is arranged in the taxonomy metadata.

According to (Debreceeny & Farewell, 2010) in the journal, said that XBRL is an open international standard for digital business reporting are managed by non-profit groups, consisting of: 1) want to improve reporting (public interest), 2) updating paper-based reports the digital version of the more useful and effective, and accurate. 3) digital business reports (XBRL format) for ease of use, share, analysis, and additional value over the data.

Based on research (David Lee, et al. 2012) the influence of XBRL already begun, with multinational companies set up a branch company in Indonesia. This can be seen in companies that already use XBRL then outstanding shares are purchased and hunted by investors. This proves that investors helped with XBRL system implemented by the company

Bank Indonesia is the first state institution to use XBRL. That where support in making financial reports to be more effective and efficient. XBRL is located in the new Bank Indonesia implemented on Sharia Bank.

Indonesia Stock Exchange (IDX)

In the website (Indonesia Stock Exchange, Indonesia Stock Exchange, 2012) Since 2012, PT Indonesia Stock Exchange (BEI) has initiated the development of XBRL-based reporting. In the framework of the implementation of the reporting, the Stock Exchange shall prepare a taxonomy that represents a reporting. As the initial development step, BEI has completed taxonomy specifically for the company's financial statements. Furthermore, the taxonomy of these financial statements will be disseminated to all of the Listed Company. Information reporting XBRL-based financial statements of the plans to be implemented in 2015. The type taxonomy existing financial statements include the statements: 1) Statement



of Financial Position; 2) Statements of Income; 3) Statement of Changes in Equity; 4) Statements of Cash Flows.

The taxonomy will standardize the format of presentation of financial statements of companies from all types of sectors and subsectors that have been set by BEI. Detailed information relating to the taxonomy and presentation will be discussed in the taxonomy menu.

After the development of the taxonomy of the financial statements, BEI will continue its development to an area taxonomic Disclosure (Disclosure). Until now, the area of disclosure that will be developed is still under discussion. Disclosure of the area can be: 1) Notes to the financial statements Issuer; 2) The obligation of information disclosure of the Issuer; 3) Information on the aforementioned corporate actions, etc.

Briefly workflow associated with the development of XBRL-based reporting can be seen in Figure 1.



Figure 1. XBRL Development Workflow

According to news from (hukumonline.com, 2015) about the use of XBRL in overcoming tax revenue is not achieved in Indonesia, that the Directorate General of Taxation will use XBRL system to track companies that do not pay taxes or late. Own XBRL will facilitate staff Direktorat General of Taxes to enter the data. This XBRL will follow a system of BEI.

Tax Accounting

Taxation is the accounting aspects of the company that arise due to a regulation, which is required by external parties to the company and coercive. Conjunction with the accounting resulting from the main activity of the company is aiming to gain profits. That is,

there is a component of money or material that is subject to tax and must be deposited to the country where the company resides.

According to (Debreceny & Farewell, 2010) in the journal XBRL in Accounting Curriculum says that information to create tax reports from various sources (regulations). In addition, a series of functions to make use of XBRL financial reporting would be better if the company could integrate tax reporting that will generate tax reports are effective and efficient.

Business

Business literally is a company that produce goods and services which require financial statements which became one of the benchmarks that illustrate the extent to which the performance of a business. The financial statements can also be communicated to investors, creditors, management, and all those who use the financial statements about how the condition of a business. In addition, the financial statements are also an aspect to be considered for taking a good decision by the investors, creditors, and management. Thus, reporting of a financial statement is very important in the business world because it can communicate with any aspect of the business performance.

What about the taxes that exist in the company? It can be seen from how the company pays taxes regularly or not, and how the company reported a tax to the State. It can be seen from an XBRL

How it Works XBRL

(KPMG Siddharta advisory, 2013) explains, XBRL reporting system involves two main parties, the sender and receiver of information.

In implementation, the role of the recipient of the information is a standard set of information in the form of XBRL taxonomy. The receiving party information also process information in XBRL format received. On the other hand, the shipper information plays submit data reports in XBRL documents (XBRL instance document) based on predefined taxonomy.



In the XBRL document creation, software affix tags to the XBRL data items company based on predefined taxonomy, such as standard taxonomy, taxonomy extension, enterprise data, tagging process, document.

Benefits and Uses in XBRL

In this case the author want to tell you the benefits and usefulness of Business Company can be seen in Table 1.

Table 1. Benefits and Uses in XBRL

Number	Type	Benefits and Uses
1.	Business Companies	<p>to produce consolidated financial statements from</p> <p>1) all divisions and subsidiaries quickly and reliably.</p> <p>2) Improve the accuracy and reliability of financial data.</p> <p>3) Provide ease of analysis, forecasting, and decision making.</p> <p>And the ease in collecting, preparing, and storing data.</p> <p>Helping business decisions more quickly and</p> <p>4) efficiently.</p> <p>The financial data can be rendered more transparent</p> <p>5) and easier to use.</p> <p>6) Simplify the process and reduce costs in the tax reporting rules and other authorities.</p> <p>7) Can avoid software systems is difficult and paid</p>

But the benefits and usefulness of XBRL for IDX core can be seen from Figure 2.

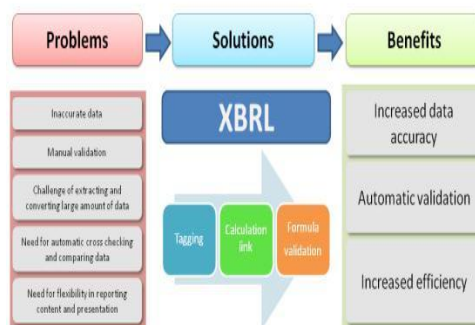

Figure 2. Benefits and Uses of XBRL For BEI

METHODOLOGY

The author uses the method of literature (literature study). First, the author seeks theories relating to the title of the paper to be the basis of the discussions that will be done. So, the author did not write an opinion that is not in order. These theories cited by author from literature sources such as books, journals, and other sources from the internet that is not a blog sites.

The author uses the technique of data collection by:

Literature Review

According to (Sekaran & Bougie, 2013, p. 49) in his book “Research Methods for Business: A Skill Building Approach, 6th Edition” the study of literature is read journals, conference proceedings, and other content that is published or not, related to the problems examined by the author to help authors understand the research and viewpoints that are used. The data can be obtained from the literature is secondary data that can be used as a theoretical basis and guidance in the discussion of the problems.

RESULT AND DISCUSSION

XBRL in Indonesia has been implemented by several state institutions in Indonesia, such as: Bank Indonesia, the Indonesia Stock Exchange and SKK Migas. The Directorate General of Taxation have a plan to use this XBRL system.

XBRL in the world of taxation has not been operated, but the plan of XBRL will be used in the world of taxation at the beginning or the end of the year 2017. The Directorate General of Taxation is already using online tax return to allow companies in Indonesia to pay taxes. XBRL will be connected to the SPT online which has been run by the Directorate General of Taxation because XBRL will be associated with the reporting of tax to be paid and reported to the State.

This XBRL will be more to the company rather than to individuals. Due to the Company in Indonesia has great risk in paying taxes. XBRL in the world of taxation would be helpful in tracking down tax authorities or companies that are not late in paying taxes. Besides being able to keep track of companies that missed or delayed paying taxes, XBRL also make it easier for the staff of Directorate General of Taxation to enter the data of the XBRL (eXtensible the Business Reporting Language) is an XML-based open standard that supports the modeling of information and company, which is the taxpayer. With the SPT online will make it easier for tax authorities to use this XBRL.

So, the use of XBRL in the world of taxation can go as desired later, the Tax Office should conduct socialization gradually into an existing company in Indonesia, providing training in the use of XBRL in taxation, as well as providing XBRL software free of charge to companies in Indonesia. It is expected to do things - things that have been mentioned above, XBRL will be run efficiently and will reduce the companies that missed or delayed in paying taxes.

CONCLUSION

Expression of semantic meaning which is usually required by business reporting. XBRL uses XML syntax and XML-based technologies to explain the semantics.

From the above discussion, it can be concluded using XBRL in the world of taxation will bring convenience to the Directorate General of Taxation and other state institutions.



That's because they can track companies that missed or delayed pay taxes to the State. XBRL will be implemented by the Directorate General of Taxation will be expected to go according to plan and XBRL are also expected will reduce companies that do not pay taxes or late.

XBRL can be used to prepare tax reports in a format that can be operated in a variety of applications reduces the need to prepare tax reports in different formats. XBRL will be used by the Directorate General of Taxation and companies in Indonesia will benefit both parties.

REFERENCES

- David Lee, S., & dkk. (2012). *Efektifitas Penggunaan Aplikasi Extensible Business Reporting Language (XBRL) dalam Pengambilan Keputusan Investasi di Indonesia*.
- Debreceeny, R., & Farewell, S. (2010). XBRL in Accounting Curriculum . *Issues in Accounting Education Vol.25 No.3*, 379-403.
- hukumonline.com. (2015, August 20). *Mengejar Pengemplang Pajak dengan Sistem XBRL*. Retrieved September 19, 2016, from hukumonline.com: <http://www.hukumonline.com/>
- Indonesia Stock Exchange Bursa Efek Indonesia. (2012). *Extensible Business Reporting Language (XBRL)*. Retrieved 2016, from Indonesia Stock Exchange Bursa Efek Indonesia: <http://www.idx.co.id/>
- KPMG Siddharta advisory. (2013). *XBRL A New Language*. Retrieved 2016, from KPMG : cutting through complexity: kpmg.com/id
- Plumlee, R. D., & Plumlee, M. A. (2008). Assurance on XBRL for Financial Reporting. *Accounting Horizons* , 22(3), 353-368.
- Romney, M. B. (2012). *Accounting Information Systems 12th Edition*. Global Edition, 12/E. Pearson.
- Samuel Olusola, F. (2011). *E-business Conflict Resolution : The Role of XBRL, The Next Generation Digital Language Of Business Reporting*. SRIMCA.
- Sekaran, U., & Bougie. (2013). *Research Method for Business : A Skill Building Approach Edisi 6*. New York: Wiley.



Sugalih Muliawirawan, Y., & Pahlisa, P. (2015). *CASE STUDY: XBRL IMPLEMENTATION FOR INDONESIA'S ISLAMIC BANKING REGULATORY REPORTING SYSTEM*. XBRL International, Inc. .

XBRL. (n.d.). *An Introduction to XBRL*. Retrieved 2016, from The Business Reporting Standard: <https://www.xbrl.org>



MEANING OF SENTIMENT ANALYSIS FOR COMPANIES

Menno van Zaanen

Department of Communication and Information Sciences School of Humanities
Tilburg University, The Netherlands
mvzaanen@tilburguniversity.edu

Lydia Mutiara Dewi

Department of Accounting, Faculty of Economics
Parahyangan Catholic University, Indonesia
l.m.d.abigail@gmail.com

Abstract

People often ask others for product advice. Once, word-of-mouth (WOM) was, due to practical limitations, shared locally. Nowadays, WOM is shared online (eWOM), which has a much larger reach. As eWOM is publicly accessible (unlike WOM), it can be used as information on brand attitude. eWOM can be aggregated and assessed using sentiment analysis (identifying positive/negative messages). The assumption is that sentiment analysis illustrates people's brand perception. We investigate the relationship between sentiment analysis and brand perception. We collected tweets with sentiment information of eight brands in Indonesia using Twitter's built-in sentiment analysis over a week. Using these tweets, aggregated sentiment scores were computed. The scores were correlated with brand perception collected using questionnaires. 206 participants attributed scores to seven properties: Complaint handling, Design, Friendliness, Information, Marketing, Service, and Overall score. Either insignificant or correlations close to zero were found, so online sentiment does not correspond to offline brand perception.

Keywords: word-of-mouth, artificial intelligence in business, sentiment analysis

JEL Classification: M29



INTRODUCTION

People often want to make an informed choice when buying products. In the past, people could ask other people in their direct surroundings for their experiences. Before buying a product, one would ask friends or family for their opinion. This type of information sharing is called word-of-mouth (WOM). Due to the physical transfer of information, only a small group of people has a major influence on the perception of products or brands.

Nowadays, with the availability of social media, sharing information has become very easy. One may write a message and share it with the entire world. Product or brand experiences can also be shared using social media and, in fact, people distribute their opinions online. Sharing this type of information corresponds to an electronic form of WOM, hence called eWOM.

An interesting side-effect of eWOM is that everybody can access this information. Not only do people use this information, companies may also access this information. In fact, many companies are active on social media in different ways. For example, they interact with customers, resolve complaints, answer questions, perform online marketing, and perhaps even influence eWOM by adding positive remarks or reduce the impact of negative messages.

Companies also collect the information that people share online about the company. The amount of information people post (especially) about the more well-known companies is huge. This means that opinions about the company will be present in this data, which may be extracted and aggregated. The idea is that there is a relationship between opinions found in eWOM and what people really think about the company. If true, collecting opinions from eWOM is a relatively cheap way to collect people's opinions of the company.

The idea that brand attitude information can be extracted from social media data, relies on the assumption that a relationship between the social media sentiment and the actual brand attitude exists. Here, we investigate what this relationship looks like. We will analyse eWOM sentiment and relate this to different properties of companies in order to answer our research question: What is the relationship between online sentiment and properties of companies?



BACKGROUND INFORMATION

Word-Of-Mouth and Electronic Word-Of-Mouth

By definition, word-of-mouth (WOM) is the process of delivering information from one individual to another. In a business context, WOM information may involve opinions, reactions, or details which consumers share concerning a product or a service (Jansen et al., 2009). WOM is primarily based on connections and trust within close social networks such as families and friends (Jansen et al., 2009). Kotler & Armstrong (2016) indicate that consumers feel more confident with what their families, friends and associates recommend about a product than what commercial sources inform by applying various modes of advertisements. Both authors even confirm that 92% of consumers take into account suggestions from families and friends more than that of any form of advertising. Hence, the WOM influence provides a major impact in consumer buying behavior. The WOM influence itself can be described as how the personal recommendations of families, friends, other consumers, and associates give a contribution to the consumer buying behavior (Kotler & Armstrong, 2016).

The development of social networks allows consumers to easily share and receive information in a large scope. They can exchange opinions about products, services, or companies on an online basis (Duan et al, 2008). This new type of word-of-mouth is known as online word-of-mouth (oWOM) or electronic word-of-mouth (eWOM) (Jansen et al., 2009).

eWOM, people collecting and sharing opinions through an online channel, has been on-going since the introduction of Web 2.0 (van de Kruis, 2013). Web 2.0, a term invented by Dale Dougherty (O'Reilly, 2007), also called a read-write web (Gillmor, 2004), allows people to interact with each other, to collaborate, to contribute to creating online material, to personalize a website for their personal use, or to express their opinion (Hew & Cheung, 2013). Several services are available, allowing people to easily and promptly share information.



Microblogging

An example of a Web 2.0 technology is microblogging (Grosseck & Holotescu, 2008). Microblogging is a type of communication that allows people to share their information in relatively short messages. Several websites provide microblogging services. Twitter is one of the most popular microblogging tools¹ (Java et al., 2007).

On Twitter, people can share messages known as tweets. The maximum length of each tweet is 140 characters (Go et al., 2009). Tweets have several specific attributes. It is possible to direct messages directly to other users, add hashtags, which allow for the categorising of tweets or simplifying search for topics, retweeting resends an existing tweet, which allows for, for example, forwarding the tweet to other users. Also, tweets often contain emoticons, which are used to indicate people's feelings. Examples of emoticons are ':)' and ':(', which represent positive and negative feelings respectively (van de Kruis, 2013; Aisopos et al., 2011).

Reviews on Twitter are different from posts on review websites such as Cnet² (van de Kruis, 2013). Due to the length limitations, people shorten words, e.g., 'great' is shortened to 'gr8' and 'congratulations' to 'congratz'. Additionally, many tweets do not follow standard spelling or grammar (Aisopos et al., 2011). These special attributes may influence the performance when analysing tweets.

To indicate the amount of information found on Twitter, 500 million tweets are sent on average every day by 317 million monthly active users in January 2017 (Aslam, 2017). In 2016, on average five businesses are followed by each Twitter user and 80% of the users mentioned a brand in their tweets. Between 2014 and 2016, the number of conversations between users and companies increased 2.5 times, and if the company gave a friendly service, 76% percent of the users are likely to recommend the brand (Smith, 2016).

A huge number of tweets contain opinions about products and brands and hence are interesting for companies. However, analysing each individual tweet manually is too time-consuming. Analysing huge amounts of tweets is possible sentiment analysis tools, such as

¹ <https://www.twitter.com/>

² <https://www.cnet.com/>



Engagor³, that automatically detect people's opinions. Relevant tweets are analysed to identify the users' opinions, which are aggregated providing information about the valence contained in the tweets. These results can be useful for the company, for example, for customer care or for deciding the next marketing strategies (van de Kruis, 2013).

Sentiment Analysis

Liu (2010) defines sentiment analysis or opinion mining as 'the computational study of people's opinions, appraisals, and emotions toward entities, events and their attributes' (p. 1). Sentiment analysis research can be applied to many internet platforms (van de Kruis, 2013), such as: blogs, social media sites (including Facebook, Youtube, Twitter, and Pinterest), virtual worlds (such as Second Life and Everquest) (Kotler & Armstrong, 2016), websites that feature reviews (Dave et al., 2003; Hu & Liu, 2004), chat rooms, news articles (Morinaga et al., 2002; Nasukawa & Yi, 2003), and message boards (Kotler & Armstrong, 2016; Das & Chen, 2007). These tools analyse the text provided by users and provide information on the valence, or the sentiment, of the users, often in the form of a value on the positive versus negative scale.

While sentiment analysis tools aim to detect people's opinions on social media sites and represent the opinions as sentiment scores, it is still not clear how well the tools perform and how they represent people's real opinion about a certain brand (van de Kruis, 2013). Moreover, Kotler and Armstrong (2016) mention that even though huge amounts of opinions can be collected on the Internet and specifically on social media, yet 90 percent of the opinions are shared in the traditional way: WOM (Kotler and Armstrong, 2016). Therefore, we need to compare the (online) sentiment scores with (offline) brand attitude to investigate how they relate to each other.

Brand Attitude

Brand attitude is the overall evaluation of a brand regarding its ability to meet the consumer's expectation (Percy and Rossiter, 1992). This evaluation can be either positive or negative (Mitchell and Olson, 1981), although there are many scales to measure brand

³ <http://cxsocial.clarabridge.com/>



attitude in the marketing literature. For example, Bruner (2012) uses nine-point Likert-type items to measure brand attitude (Bruner, 2012), whereas van de Kruis (2013) uses ten-point-Likert scales. Here, we rely on the definition of attitude by Krech et al. (1962): an ‘enduring system of positive or negative evaluations, emotional feelings, and pro or con action tendencies with respect to social objects’ (1962, p. 139). This definition can be converted into properties that, combined, measure brand attitude (van der Kruis, 2013).

1. Overall appreciation: evaluation of a certain brand or product.
2. Rating of the design: evaluation of the design of a product.
3. Rating of the service: general perception of how the company provides service (i.e., handling sales transactions properly, providing proper after sales service, and so forth).
4. Rating of customer friendliness: evaluation of the friendliness of the personnel.
5. Rating of complaint handling: evaluation of how complaints are handled.
6. Rating of information provision: evaluation of the product, service, or company procedure information provided by the company.
7. Rating of the marketing and communication: evaluation of how the company communicates and positions its products (i.e., an attractive advertisements, etc.).

METHODOLOGY

To investigate the relationship between the offline and online sentiment of companies, we ask people their opinion of certain properties of the companies under consideration and collect sentiment data about these companies from social media. The offline sentiment is collected through questionnaires, whereas the online sentiment comes from sentiment analysis of tweets.

As we do not know which properties people refer to when sharing the sentiment online, we asked people in the questionnaire to indicate their opinion on several properties: overall appreciation of the brand or product (overall), product design (design), service of the brand (service), customer friendliness (friendly), complaint treatment (complaint), provision of information (information), and marketing and communication (marketing). In total, 206 people participated in the questionnaire.



During the same period as collecting the offline sentiment information, we collected tweets of the same companies. Tweets that contain the name of the company were downloaded using the Twitter API (<https://dev.twitter.com/>). We separated these tweets into positive and negative categories based on the basic sentiment analysis tool of Twitter, which relies on the identification of positive and negative emoticons (':)') and ':('). Tweets that originated from the companies are not taken into account.

Based on the counts, we computed sentiment scores in six different ways. For the 'pos' and 'neg' metric, we only use the absolute counts of the positive and negative tweets, respectively. The 'sum' metric is the sum of the 'pos' and 'neg' metrics, whereas the 'diff' metric is the difference of the 'pos' and 'neg' metrics. These metrics denote absolute counts, but the number of tweets may be different per company, so we also compute two normalized metrics: 'pos_norm', which is the 'pos' metric divided the 'sum' metric, whereas 'diff_norm' is the 'diff' metric divided by the 'sum' metric.

Remember that we expect there to be a relationship between the sentiment score based on the tweets and the questionnaire results. To be able to compute correlations, we need several measurements, which are obtained by collecting sentiment values (offline and online) of several companies. We selected eight well-known companies that are active in Indonesia: Starbucks, JCo, Telkomsel, XL Axiata, TIKI, JNE, Honda, and Toyota. These companies were selected because most people know them and we expect there to be enough tweets to reach a reliable sentiment score.

RESULTS

The results of the questionnaires can be found in Table 1. The cells contain the mean and standard deviation values (between brackets) for each of the properties and brands. The values are in the range between one and ten, where ten is best and one is worst. We see that in general, the brands receive positive scores for all properties. Also, the standard deviations are low, indicating that people tend to agree on these values.



Table 1. The numbers denote averages and standard deviations (within brackets) for each of the properties for each of the brands. The numbers fall in the range between one and ten with ten being best.

Brand	Complaint	Design	Friendly	Information	Marketing	Service	Overall
Starbucks	7.26 (1.47)	7.79 (1.31)	7.96 (1.29)	7.49 (1.45)	8.04 (1.41)	7.92 (1.25)	8.00 (1.25)
JCo	6.92 (1.37)	7.92 (1.17)	7.37 (1.25)	7.06 (1.37)	7.17 (1.47)	7.44 (1.26)	7.79 (1.18)
Telkomsel	7.02 (1.75)	7.34 (1.44)	7.52 (1.45)	7.38 (1.58)	7.78 (1.36)	7.34 (1.69)	8.12 (1.16)
XL Axiata	6.76 (1.50)	7.29 (1.47)	7.02 (1.38)	7.05 (1.40)	7.41 (1.36)	7.06 (1.46)	7.25 (1.39)
TIKI	6.67 (1.34)	7.17 (1.15)	6.87 (1.21)	6.77 (1.39)	6.62 (1.58)	7.10 (1.29)	7.38 (1.15)
JNE	6.78 (1.58)	7.61 (1.27)	7.06 (1.37)	7.13 (1.40)	7.25 (1.45)	7.44 (1.30)	7.93 (1.17)
Honda	7.60 (1.27)	8.15 (1.17)	7.78 (1.16)	7.70 (1.27)	8.05 (1.20)	7.86 (1.19)	8.32 (1.07)
Toyota	7.62 (1.30)	8.03 (1.12)	7.82 (1.13)	7.76 (1.25)	8.05 (1.18)	7.96 (1.16)	8.22 (1.10)

The sentiment scores that are computed based on tweets for each of the brands can be found in Table 2. We collected tweets for one week. The numbers of tweets that contain sentiment are found in the columns ‘pos’ for positive and ‘neg’ for negative. The ‘sum’ and ‘diff’ columns contain the sum (total number of tweets containing sentiment) and difference (between the positive and negative sentiment) respectively. Additionally, normalized counts, found in the ‘pos_norm’ and ‘diff_norm’ columns, are presented. These two columns are investigated to make sure that the differences in absolute numbers do not have a major influence on the sentiment value.

Table 2. The numbers represent absolute counts of tweets per brand (in the pos, neg, sum, and diff columns) or normalized scores (in the norm_pos and norm_diff columns).

Brand	pos	neg	sum	diff	pos_norm	diff_norm
Starbucks	10	10	20	0	0.500	0.000
JCo	3	6	9	-3	0.333	-0.333
Telkomsel	4481	71	4552	4410	0.984	0.969
XL Axiata	3	1	4	2	0.750	0.500
TIKI	31	9	40	22	0.775	0.550
JNE	212	32	244	180	0.869	0.738
Honda	57	11	68	46	0.838	0.676
Toyota	20	1	21	19	0.952	0.905



Given that we expect there to be a correlation between the online and offline sentiment scores, we compute the Pearson's product moment correlation between the offline and online sentiment scores. This should result in significant positive correlations which means that if the online sentiment is high, the offline sentiment should also be high and vice versa for low sentiment.

Computing the correlations, we see that this only leads to significant correlations for some of the combinations. All significant correlations ($p < .05$) can be found in Table 3. We see that even when a significant correlation can be found, the correlation coefficient is very close to 0, meaning that no linear correlation between the variables can be found.

Table 3. Pearson's correlations between the online (columns) and offline (rows) sentiment results. Missing numbers indicate that no significant correlation was found.

Property	pos	neg	sum	diff	pos_norm	diff_norm
Complaint	-	-	-	-	-	-
Design	-.093	-.090	-.093	-.093	-.053	-.053
Friendly	-	-	-	-	-	-
Information	-	-	-	-	.068	.068
Marketing	.057	-	.057	.057	.072	.072
Service	-.049	-	-.049	-.049	-	-
Overall	.077	.091	.077	.077	.079	.079

DISCUSSION AND CONCLUSION

In this research, we investigate the relationship between sentiment collected from online, social media networks, like Twitter, and offline sentiment, which corresponds to the brand attitude of people 'in real life'. We collected sentiment values for a week from tweets for eight well-known brands in Indonesia and at the same time asked people for their brand attitudes of the same brands through questionnaires.

We expected there to be a correlation between the online and offline sentiment values, although the nature of this correlations was unknown. Therefore, we asked people to provide



their brand attitude for seven different properties of brands. This allowed us to investigate potential correlations between the online sentiment and each of the brand properties.

The results showed that no correlation between the online sentiment values and any of the seven offline sentiment values can be found. There may be several explanations for this. Firstly, the data collection may have introduced problems. The results of the questionnaire do not show much variation, so finding a correlation is difficult. Also, the results of the online sentiment may be problematic. For example, the identification of the sentiment of a tweet might have been unreliable and more advanced sentiment analysis tools for Indonesian may be required. Alternatively, one week might not have been enough time to collect reliable data.

Another problem may be that correlations do exist, but are not consistent over the brand properties between companies. In other words, it might be the case that for one company the online sentiment scores correlate with one property and for another brand they correlate with another. If we want to measure this, we will need to collect data for each of the different companies (both online and offline) over a longer period of time, allowing us to compute correlations over time. The fact that different types of companies are used in this research may have influenced this.

To summarize, companies use online sentiment analysis tools to measure brand attitude. However, we have shown that the interpretation of the sentiment scores is more complex than simply assuming that this is indicative of the overall brand attitude. Either more research into the reliability of the sentiment analysis tools needs to take place, or a more in depth analysis of what people write in tweets is required to link the results to specific brand properties. Online sentiment analysis may provide a useful tool, but care has to be taken when used.

REFERENCES

- Aisopos, F., Papadakis, G., and Varvarigou, T. (2011), Sentiment Analysis of Social Media Content using N-Gram Graphs. In Proceedings of the 3rd ACM SIGMM International Workshop on Social Media, ACM pp. 9-14
- Aslam, S. (2017, 1 24). Retrieved from Omnicore: <https://www.omnicoreagency.com/twitter-statistics/>



- Bruner, G.C. (2012), *Marketing Scales Handbook: A Compilation of Multi-item Measures for Consumer Behavior & Advertising Research*, Vol. 6, GCBII products, Carbondale.
- Das, S. R., & Chen, M. Y. (2007), Yahoo! for Amazon: Sentiment extraction from small talk on the web. *Management Science*, 53(9), pp. 1375-1388
- Dave, K., Lawrence, S., and Pennock, D. M. (2003), Mining The Peanut Gallery: Opinion Extraction and Semantic Classification of Product Reviews. In *Proceeding of the 12th International Conference on World Wide Web*, ACM, pp. 519-528
- Duan, W., Gu, B., and Whinston, A. B. (2008), Do Online Reviews Matter? - An Empirical Investigation of Panel Data. *Decision Support Systems*, 45(4), pp. 1007-1016
- Gillmor, D. (2004), *We the Media: Grassroots Journalism by the People, for the People*, O'Reilly Media, Sebastopol, California.
- Go, A., Bhayani, R., and Huang, L. (2009), Twitter Sentiment Classification using Distant Supervision. *CS224N Project Report*, Stanford, pp. 1-12
- Grossecq, G., and Holotescu, C. (2008), Can We Use Twitter for Educational Activities? In *4th International Scientific Conference, eLearning and Software for Education*, Bucharest, Romania.
- Hew, K. F., and Cheung, W. S. (2013), Use of Web 2.0 Technologies in K-12 and Higher Education: The Search for Evidence-Based Practice. *Educational Research Review*, 9, pp. 47-64
- Hu, M., and Liu, B. (2004), Mining and Summarizing Customer Reviews. In *Proceedings of the tenth ACM SIGKDD International Conference on Knowledge Discovery and Data Mining*, ACM, pp. 168-177
- Jansen, B. J., Zhang, M., Sobel, K., and Chowdury, A. (2009), Micro-blogging as Online Word of Mouth Branding. In *Proceeding of the 27th International Conference Extended Abstracts on Human Factors in Computing Systems*, ACM, pp. 3859-3864
- Java, A., Song, X., Finin, T., and Tseng, B. (2007), Why We Twitter: Understanding Microblogging Usage and Communities. In *Proceedings of the 9th WebKDD and 1st SNA-KDD 2007 Workshop on Web Mining and Social Network Analysis*, pp. 56-65
- Kotler, P., and Armstrong, G. (2016), *Principles of Marketing*, 16th ed., Pearson, Boston.



- Krech, D., Crutchfield, R. S., and Ballachey, E. L. (1962), *Individual in Society*, McGraw-Hill, New York.
- Kruis, S. van de. (2013), *Sentiment Analysis on Tweets Measuring the Correctness of Sentiment Analysis on Brand Attitude*. Master Thesis Communication and Information Sciences Tilburg University, pp. 1-58
- Liu, B. (2010), *Sentiment Analysis: A Multi-Faceted Problem*. *IEEE Intelligent Systems*, 25(3), pp. 76-80
- Mitchell, A. A., and Olson, J. C. (1981), *Are Product Attribute Beliefs the Only Mediator of Advertising Effects on Brand Attitude?* *Journal of Marketing Research*, pp. 318-332
- Morinaga, S., Yamanishi, K., Tateishi, K., And Fukushima, T. (2002), *Mining Product Reputations on The Web*. In *Proceedings of the eighth ACM SIGKDD International Conference on Knowledge Discovery and Data Mining*. ACM, pp. 341-349
- Nasukawa, T., and Yi, J. (2003), *Sentiment Analysis: Capturing Favorability using Natural Language Processing*. In *Proceeding of the 2nd International Conference on Knowledge Capture*. ACM, pp. 70-77
- O'Reilly, T. (2007), *What Is Web 2.0: Design Patterns and Business Models for the Next Generation of Software*. *COMMUNICATIONS & STRATEGIES*, 65(1), pp. 17-37
- Percy, L., and Rossiter, J. R. (1992), *A Model of Brand Awareness and Brand Attitude Advertising Strategies*. *Psychology & Marketing*, 9(4), pp. 263-274.
- Smith, K. (2016, 5 17). *Brandwatch*. Retrieved from *Brandwatch Blog*: <https://www.brandwatch.com/blog/44-twitter-stats-2016/>



**COMPETITIVE ANALYSIS MODEL IN GARMENTS INDUSTRY: CASE STUDY
OF PT. PAN BROTHERS, TBK**

Ginanjar Kurnia

Master of Management Science Program, Universitas Padjadjaran
ginanjar.kurnia@gmail.com

Popy Rufaidah

Faculty of Economics, and Business, Universitas Padjadjaran
popy.rufaidah@fe.unpad.ac.id

Syaifuddin

Economic Faculty, Quality Medan Indonesia University
drsyiaifuddin@gmail.com

Abstract

The purpose of this paper is to discuss the competitive analysis model in the garment industry in Indonesia through case study of PT Pan Brothers, Tbk. The paper provides results of analyzing forces in the company is known as a producer of Line of Products produced by the company are “Woven Garments” such as Padded and Light Weight Jackets, Pants, Shorts, Casual Pants and Dress Shirt, etc.

The research use case study method that aims to present information in structured, factual, and accurate information on the object studied. Case study method is used to examine the forces that pushed industry to evolve; and to identify other strategic strengths faced by the company. The findings of this study show that five forces in the industry that pushed the garment industry are evolving. This paper also shows the results of the analysis of the competitive environment consisting of bargaining power of suppliers, bargaining power of buyers, potential new entrants, substitute products and rivalry amongst existing firms in the industry. Additionally, this study resulted in the identification of a number of strengths and weaknesses of the company based on the areas of finance, marketing, human resource



management and operations of the company. The study also analyzed the value chain of the company to examine the linkage found amongst activities.

This study provides managerial impact to the company studied, namely: (1) the financial ratio analysis shows the company's financial performance is considered good and increased net income / net sales increased by 23.65% per year from 338.5 million USD in 2014 to 418 million USD in 2015; (2) marketing performance analysis shows the company's website has not empowered to maximum as e-commerce sales system is weak; (3) the production performance shows the procurement of raw materials are still imported from China and Guang Zhu; (4) human resources assessment and performance monitoring system still used a manual system.

This paper discusses a case study of the forces of the industry faced by PT Pan Brothers, Tbk. and displays the results of the analysis of the strengths and weaknesses of the company's financial functions, marketing, human resource management and operations of the company; as well as a number of opportunities that need to be captured companies and a number of threats that need to be avoided.

Keyword: *Competitive Analysis, SWOT Analysis, and Garment Industry*

JEL Classifications: *M29, L67*

RESEARCH BACKGROUND

The globalization era that grows rapidly invents the competition to be competitive. Much developing company with the various business ventures have been growing rapidly and the garment and textile industry is one of them. The development of garment industry in Indonesia has been growing broadly. The textile industry and production (TPT) contributes the highest foreign exchange for almost five years about 6 billion \$ per year. The growth of this industry has also produced a lot of vacancy jobs in 2011 about 1,4 million workers worked in this industry or increased 4,78% from the total workers last year which was 1,4 workers (Kemenperin:2016).

The development of this garment and textile industry and production (TPT) inflicts the industry competition in Indonesia. PT. Pan Brothers Tbk is one of the competitors in this industry. The company which is located in Tangerang established in 1980, moves in garment



and textile industry to generate various garment products. This company is the distributor orienting on export. The competitors of the company that has performed go public which are PT Sri Rejeki Isman Tbk. and Pt Indorama Synthetics Tbk. The businessman will produce competitive products with the purpose of appealing people's attention to use their products.

A company has surely a goal. The primary goal of a company is to escalate the shareholder's prosperity by increasing the company value (Salvatore, 2005). The company with a good performance keeps growing and can stand its industry then the company requires to analyze its financial or non-financial performance by evaluating its business. Another valuation that is usually performed is SWOT analyzing to evaluate internal or external factor that can persuade company's performance, besides that, to figure out the strategy, which is used by the company for being competitive in the business, also to develop the company. Business valuation of a company from the financial side can be asserted by analyzing the annual report of a company with financial ratio analyzing method.

From the above description of the problem formulation of the study, there should be a study to analyze the competitive analysis model in garments industry through Case Study of PT. Pan Brothers, Tbk. which would be benefited for the industry analyzed. This paper is organized as follows: Section 1 contains the profile of the company based on financial performance. Section 2 presents the reason for using case study method and the research design, the criteria used to interpret the findings of the results. Section 3 discusses the findings of the study. The paper concludes the results of the study in Section 4.

LITERATURE REVIEW

The *competitive analysis* approach can be used to help select the strategy, which has been developed before by Michael Porter (1985 in Rufaidah 2014). This approach assumes that by analyzing the strength that forms an industry can predict generally the industry profit and the possibility of success from every strategy in the business unit. According to Porter (1985), there are five primary strengths that shape an industry: *Power of Supplier, Power of Buyer, Availability of Substitutes, Barriers to Entry & Exit and Rivalry among Competitor*.

There are two opinions in this competitive analysis (Barnat, 2014): (1) the more strength that forms an industry, the lower returns in the industry; and (2) the main strength



influences business unit so that the profit for the unit is lower. The strength of competitive analysis gives a systematically way in evaluating the industry and providing the strategic option in business unit in encountering the industry. Whereas the weakness of competitive analysis is (1) difficult to recognize what has influenced the industry strength, and (2) the success key of a company is to collaborate not compete.

RESEARCH METHODS

This study used case study method to examine an issue deeply by analyzing the company strategy and viewing the strength and weakness, opportunity and threat so that the company can be heading in the industry competition to accomplish *competitive advantage*. The procedure of this case study is: *first*, selecting the case. By choosing the phenomenal case in a society with the aim of finding the solution to the issue that occurs; *second*, data collection. Data and information about the study issue are collected from the annual report of company and journals; *third*, data analysis. Data analysis and organizing are carried out to clarify previous data; *fourth*, correction. Data that has been collected is refined and strengthened with new data on the category which has been found; *fifth*, reporting. The report is written down communicatively and describing phenomena in the study.

RESEARCH RESULTS AND DISCUSSIONS

Strategic Posture of the Company

PT. Pan Brothers Tbk started operating commercially in 1981. The main activity of the company moves in apparel industry by producing various clothes. The company share was firstly offered to the people in 1990 and recorded in Indonesian Stock Exchange (ISE) since 1990. PT Pan Brothers Tbk is managing the industry from developer sector, distributor, garment producent and the subsidiary company produce various clothes such as the jacket, dress shirt, active wear dan polo shirt.

The market of PT Pan Brothers Tbk and its subsidiary company are The North Face, Adidas, Hugo Boss, Nike, Prada, Tigha and Yonex. The majority market of PT. Pan Brothers, Tbk is to export the products to United States, European Community, East Europe, Canada,



Asia, Australia and other countries. The company has some competitors which are: *first*, PT Indorama Synthetics Tbk (INDR). This company has recorded the highest sales about US\$ 682 million or 8,98 billion IDR (rate 13.170 IDR/US\$); *second*, PT Sri Rejeki Isman Tbk (SRIL) or is known as Sritex, by reaching the sales about US\$ 631,3 million in 2015 or 8,3 billion IDR (rate 13.170 IDR/US\$) or increasing 7,2% from 2014 about US\$ 589 million; *third*, PT Asia Pacific Fibers Tbk (POLY). This company resulted from the sales US\$ 390 million in 2015 or 5,13 billion IDR, decreased 21,5% than 2014 about US\$ 493,5 million. In this competition, PT Pan Brothers Tbk has been able to reach the sale about US\$ 418,6 million in 2015 or 5,5 billion IDR, increase 23,6% than 2014 about US\$ 338,5 million. The gross profit of this garment producent has grown significantly about US\$ 53,6 million in 2015 than 2014 about US\$39,6 million. But, the company net income has weakened into US\$ 8,6 million 2015 than last year which was US\$ 9,3 million.

Financial Performance

The company financial performance is analyzed for over two years which is from 2014 to 2015, some financial aspects have increased and decreased, more detail can be viewed from this table:

Table 1. Financial Performance

Ratio/Year	2015	2014
Liquidity Ratio		
Current ratio	359,845%	382,175%
Quick ratio (acid test ratio)	257,129%	291,496%
Cash ratio	85,296%	171,878%
Cash Turn Over	72027,683%	157639,496%
Inventory to net working capital	39,530%	32,135%
Leverage ratio		
Debt to asset ratio	51,526%	45,254%
Debt to equity ratio	105,155%	82,339%
Long-term debt to equity ratio	62,501%	41,173%
Times interest earned	258,044%	290,238%



Activity Ratio		
Receivable turn over	6,374	6,531
Average collection period	57,264	55,890
Inventory turn over	4,722	5,020
Working capital turn over	1,876	1,613
Fixed assets turn over	3,407	4,468
Total assets turn over	1,844	2,041
Profitability Ratio		
Gross profit margin	12,813%	11,685%
Return on investment	3,798%	5,623%
Return on equity	3,944%	4,630%
Earn per share	0,140%	0,150%
Net profit margin	2,060%	2,755%
Book market ratio		
Price earning ratio	400.000	336.667
Market book ratio	47.886	43,183
Market value added	0,102	0,089

It can shortly be known that the company *net sales* increased from US\$ 338,5 million to US\$ 418, 6 million. In *current ratio* aspect, the company decreases 22,33% in 2015, financial ratio evaluating is in the poor category. Money indicates the company ability in paying off the short-term debt by using the short-term asset. Even though decreasing, the company is able to pay off the short-term debt. It is because of the increasing of the company asset and the *current liabilities* company has also escalated. The implication of paying off the short-term debt impacts the *cash ratio* company. The decreasing of cash ratio in 2015 was about 85,296 which means that the company can pay 0,85296 IDR for every a rupiah debt. It indicates that the company is unable to maximize the cash and marketable security to pay off the short-term debt.

The increasing of the financial ratio company can be detected in *debt to asset ratio*, which escalates to 51,526% in 2015 or 6% from last year 45,254%. It means that the



company has utilized liability in costing the company asset. It is in a good category. But, *debt to equity ratio* (DER) is increasing. The total company debt with the capital is beyond 50% of the company capital which indicates that the company is not good enough. However, the company achievement is on target that has been agreed which is, maintaining equity ratio on debt about 250%.

The company financial performance in *activity ratio* has been decreasing. The company *receivable turnover* (RTO) decreased about 0,157 from last year, the implication on the company was that it rendered the decreasing of profit because the inability company in selling efficiently by utilizing *account receivable*. However, the company inventory turnover (ITO) escalates to 0,298 than last year. This increase signs a good for the company. The increasing of this ratio renders the increase of sales by utilizing the available stock.

The increasing of the company financial ratio cannot be viewed from *gross profit margin* which is, escalating from 0,0113 in 2015 to 12.813%. it means that the company has 12,813% margin that can be used to cover the burden and still result in a profit.

Competitive Analysis

The industry competition of textile industry and production in Indonesia is quite rapid and it invents PT Pan Brothers to be able to analyze the competition. Here is the competitive analysis by using the five force model approach by Porter (1985): (1) *Rivalry among Competitors*, the company should be more aggressive in competing by providing many kinds of products, competitive price, and on-time delivery. The company has to maximize utility and various systems and technology which can help and accelerate the production, workers development continually to keep competing in the global market and contributing to the Indonesia export market; (2) *Barriers to Entry & Exit*. The barriers in this textile industry and production is quite heavy, it can be detected from many companies with their familiar brand, through partner system as a supplier of garment products, they have been a united system and bounded to each other for a long time; (3) *Availability of Substitutes*. The competition is tight in this industry, it makes the company realize many substitute products which can replace the main product of the company so that they need to emphasize the high quality of products which are sold to the customer and provide them a competitive price; (4) *Power of Buyer*.



The company must enhance *new buyers* and empower the old buyers with a new product to escalate total order and improve the type of product. The company has a lot of buyers and always gain new buyers and maintain the dependency on the certain buyer. So that, the maximal portion of every buyer is determined on the limit about 30% of total sales; (5) *power of supplier*. The company needs to collaborate with the material supplier to obtain a beneficial synergy for the development of the company. The company needs to keep seeking and cooperating with a company which has an experience in producing another garment so that it invents them as the company vendor which works for the company.

External Environment Analysis

The condition of the external company brings some chances and threats on the company achievement to a goal. The opportunity and threat factors are summed up in the table *EFAS* (External Strategy Factor Conclusion):

Table 3. of EFAS PT. Pan Brothers, TBK

External Strategic Factor	Quality	Rating	Score
A. Oportunity of PT. Pan Brothers, TBK			
1. Indonesia is supported by the available of the workers, infrastructures, resources for industry based on rayon, nylon, and filament with or without the combination of cotton (O1)	0,15	4	0,60
2. The company asset is consistent per 31 December 2015 about US\$ 122.9 million, increasing about 46,54% (O2)	0,06	3	0,18
3. The company predicts Indonesia export will escalate and have the opportunity for the company which is able to compete in the global market (O3)	0,05	3	0,15
4. The lifestyle and the activity of urban customers change, it opens an opportunity for the garment industry (O4)	0,09	2	0,18

5. The Government of Indonesia by The regulation of Ministry of Industry Number 123/M-IND/PER/11/2010, supporting the textile industry and production (<i>TPT</i>), by subsidizing 10% of purchasing new machines to renew this sector, publishing economic packet regulation which is for intensive industry (tax intensive, electricity discount, tax cuts for the workers), launching Free Trade Agreement with Europe in 2017) (05)	0,15	4	0,60
B. Threat of PT. Pan Brothers, TBK			
6. The economy of destined export country is worse, the other possibilities that will influence the sales (T1)	0,12	4	0,48
7. The change of economic and politic in the regional or destined country will weakened the company performance (T2)	0,10	2	0,20
8. The entry logistic is canceled and it will obstruct on time delivery and reduce the customer trust on the company (T3)	0,15	3	0,25
9. The strength or weakness of rupiah is beyond the limit and the increasing of the domestic cost such as standard minimum wage; oil; electricity; cellular etc that will decrease the power of competition of a company (T4)	0,13	3	0,39
TOTAL	1,00		3,03

Business Performance Analysis

The strategic management is a whole plane that directs to the attempt of achieving the company goal. To figure out the business performance of PT Pan Brothers Tbk can use business performance analysis which is divided into internal and external company factors called as SWOT analysis, it is used to recognize the strength, weakness, opportunity, and threat of a company. Business performance analyzes is done by identifying the strengths and weaknesses of the company through business functions, namely, marketing, finance, operation and HRM. In the next paragraph, the result of the strength and weakness analysis is arranged into IFAS (Internal Factor Analysis Summary) Table.



Marketing Performance: the trusty garment product which is distributed to United States, European Community, East Europe, Canada, Asia, Australia etc. The company provides retail apparel to serve the regional market. The company has marketing resources that will contact one by one of a buyer to offer the product. If the deal is agreed then the marketing resources will keep in touch with the buyer.

Financial Performance: the decision in managing the company financially is about 10% of the profit will be used to increase the capital to support the company operational. About 30% of the stock is allocated to invest from up to down to strengthen the position in the industry, by Entitas Anak. Besides that, the company funds US\$ 40.000.000 for Committed Capex Term Loan Facility (TLF). The aim of this facility is for investment credit with the level of Libor interest + 3.5%.

Operation Performance: the company develops an alliance with the material supplier and garment manufacturer, which is possibly managed to become coordinated garment manufacturer with the company to escalate the production capacity. The company is also a supplier of the garment material and supplying to garment manufacturer so that the company becomes the synchronized company in supplying chain that is completed from up to bottom. With self-developing to up from garment manufacturer to all industries which are textile, spinning, and fiber. To keep the quality product, the company applies the quality international standard and adopt ISO 9001:2008 – Management Quality International Standard by bringing in the high-quality material and cheap which is from China and Guang Zhu.

Human Resources Management Performance. The total workers of the company at the end of 2015 were about 32.707 workers. It is a precious asset for the company that has to be maintained and developed. The development is carried out by implementing the training of operational technic and leadership to accomplish competitiveness and productivity of a company. Evaluation of human resources performance is carried out by evaluating all workers from *Assistant Supervisor level*, to detect potency and competency that can be developed and push on with education training.

Information System Management Performance. The system information management performance in PT Pan Brothers Tbk is divided into three management



functions, which are (1) Operational Level, the company utilizes a Turbocash software to help the accounting (recording the sale and purchase transactions), the company also uses the Microsoft outlook to make an email program; (2) Managerial Level, the company uses the integrated information system and user-friendly, so that it will not take a long time to log in; (3) Strategic Level, using portfolio apps to find out the contribution of the company's apps by grouping the apps into categories such as *high potential strategic, key operational, support*.

Table 4. IFAS PT. Pan Brothers, TBK

Internal Strategic Factor	Quality	Rating	Score
A. The Strength of PT. Pan Brothers, TBK			
1. Experiencing in running a unit business (S1)	0,20	4	0,80
2. The High quality product (S2)	0,10	4	0,40
3. Serving the regional market (S3)	0,10	4	0,40
4. Available cash to expand (S4)	0,10	3	0,30
B. The Weakness of PT. Pan Brothers, TBK			
1. The high dependency on materials from foreign country (W1)	0,15	4	0,60
2. The level debt in the future (W2)	0,10	2	0,20
3. The higher loan interest rate (W3)	0,10	2	0,20
4. The competitive market (W4)	0,15	3	0,45
TOTAL	1,00		3,35

Value Chain Analysis

The company has some activity chains that are carried out to generate the product or service which is called as the value chain. PT Pan Brothers Tbk has some subsidiary companies which produces and supplies the products based on the customer demand. The primary activity that is carried out by the company is (1) **Inbound Logistic**. Logistic consists of procuring textile materials such as *polyester, single jersey, pique, fleece in cotton*. The controlling management of quality is carried out in this step. The company has barriers to perform inbound logistic which is, purchasing additional material such as accessories, tailor



etc. PT Pan Brothers Tbk receives the materials from the supplier which is its own subsidiary company. For example, the company collects the materials for, PT. Pancaprima Eka Brothers, PT Hollit International, and PT Ocean Asia Industry; (2) **Operation**. This activity consists identifying the product. The selecting material process is adapted to the pattern and kind of product which has been ordered before, measuring the material, sewing and printing the motif. The company maximizes the utility, system, and technology that can help and accelerate the production. Nowadays, the company has been prepared to supply all kinds of garments and invent the company as one stop shopping for the buyer for every kind of garment. The production capacity of garment segment in 2015 was supported by 22.186 sewing machines, and in 2016 the production capacity target has increased to 96 million pieces; (3) **Outbound Logistic**. The management system in Outbound Logistic consists of packing, labeling, releasing and delivering the product. (4) **Marketing and Sales**. The majority products are the export products. The self-development from garment manufacturer to become the brand holder and garment retail. It is started with getting a license to sell in Indonesia and Asia from some garment brands. Entering retail and developing their own brand; (5) **Service**. The development is performed to enhance alliance with garment manufacture which is possible managed to be coordinated garment manufacture with the company to escalate production capacity for the best service to the customers.

The support activity that is performed by the company in the value chain is (1) **Company Infrastructure**. The infrastructure to support the company activity is the material and the support production material, sewing machine and wave machine, support service such as transportation, communication, tool, safety equipment. (2) **Human Resources Development**. With the commitment, the company has been training the workers in 2015. The training embraces operational technic or leadership to accomplish the company competitive and productive. To develop the worker's competency, the company has been evaluating the workers from assistant supervisor level, to see the potential that can be developed and implementing education training. (3) **Technology Development**. The company keeps trying to escalate and optimize the efficiency, productivity, the quality product, through modernization machine periodically; applying quality management system ISO 9001:2008 by consistently implementing the integrated information with all divisions in



the company such as *Supply Chain Management*, *Turbo cash*, *Quality Assurance System*, so that the company can set the right price for the buyer. (4) **Procurement**. The company hires HR based on qualification and competency that is required and purchasing the material, infrastructure, and other resources.

CONCLUSION

The *competitive model analysis* is used to help the management in making a strategic decision, by analyzing the competition industry, the company can predict the next step to achieve a goal. The company must have a competitive advantage to stand in the competition. The advantage is something that can make the company more competitive in appealing the customer interest and survive in the force of competition. By utilizing the advantages, the company can shape a competition strategy. The company that is able to compete, it will be able to stand the business and strengthen its position in the market industry.

The Competition among The Same Company: Many regional companies which move in the same industry which are PT Indorama Synthetics Tbk, PT Sri Rejeki Ismani, and, PT Asia Pacific Fibers also have a market in the outside Indonesia. The foreign competitor is from China, the advantage of this company is to set the cheap price with the good quality. Maintaining the quality product and also attempting to reduce the cost of material is one of the competition strategies that is performed by PT Pan Brothers Tbk.

The Entry of New Competitor: The new competitor with the advantage competitive has forced PT Pan Brothers Tbk. But, the capital factor that is required such as materials, workers, and infrastructure capacities to build a garment company particularly entering the foreign market needs a big cost. PT Pan Brothers Tbk is well known and has a loyal customer in outside Indonesia, it invents the company not to worry about the threat from the new comer in the garment industry.

The Development of Substitution Product: The substitution product gives a chance for the customer to switch old product to a substitute product. The substitution product of PT Pan Brothers Tbk is the products which are sold in the regional and those which are made by China company.



Power of Supplier: The company receives the primer material from the supplier. So that when the chips are down to find the material from other suppliers then it will give a chance the supplier to offer. The supplier of PT Pan Brothers Tbk is from China and Guang Zhu. On the other hand, the dependency of the materials from foreign country becomes a threat for the ongoing of the company if the exchange rate is unstable and fluctuating.

Bargaining power of Buyer: The strength of offering the buyer which gives an opportunity to the customer to offer the price so that it will persuade the competition intensity in the industry. PT Pan Brothers Tbk is keeping the good relation with the customer so that the company can use the strategy in negotiating the price or warranty.

RECOMMENDATION

Based on the strategic factors mentioned above, the recommendation that is required to do by the company in accomplishing the goal is: (1) **The strategic factor in short-term:** the company needs to monitor the fluctuation of rupiah to predict the sale and purchase materials so that the company is able to adapt with the consequence of the rupiah fluctuation. (2) **The strategic factor in medium-term:** Maintain the market that has been reached and targeting the new market such as medical industry. (3) **The strategic factor in long-term:** Utilize the new technology that can reach all markets such as medical industry so that the company can rule all markets.

REFERENCES

- Annual Report PT. Asia Pacific Fibers Tbk. Jakarta. 2015
- Annual Report PT. Indorama Synthetics Tbk. Jakarta 2015
- Annual Report PT. Pan Brother, Tbk. Tangerang 2014-2015
- Annual Report PT. Sri Rejeki Isman Tbk. Jakarta 2015
- Barnat, Ryszard. 2014. *Strategic Management: Formulation and Implementation*. (online). Tersedia: <http://www.introduction-to-management.24xls.com/en321> (diakses 25 maret 2017)
- Kementrian Perindustrian. 2016. *Prospek Industri TPT Cerah*. (online). Tersedia: <http://www.kemenperin.go.id/artikel/5314/Penyerapan-Tenaga-Kerja-Masih-Tinggi> (diakses pada 20 Maret 2017)



Porter, Michael. 1985. *Competitive Advantage Creating and Sustaining Superior Performance*. New York: The Free Press

Rufaidah, P. 2014. *Manajemen Strategik.*, Edisi Pertama, Cetakan Ketiga, Penerbit Humaniora, Bandung.

Salvatore, Dominic. 2005. *Managerial Economic*. Fith Edition. Singapore: Thomson Learning



**INDUCTIVE REASONING IN MARKETING RESEARCH TO RESPOND THE
FUTURE MARKET CHALLENGES**

Andhi Sukma

Universitas Widyatama

Harriman Saragih

Universitas Pelita Harapan

harriman.saragih@uph.edu

“An exciting and inspiring future awaits you beyond the noise in your mind, beyond the guilt, doubt, fear, shame, insecurity and heaviness of the past you carry around.” – Debbie Ford

Abstract

This paper aims to provide the definition of inductive reasoning and explain its importance in the field of business and management research to respond to the future market challenges. On this paper, we will first describe the basic understandings of two types of scientific reasoning concepts which are deductive and inductive, including the idea of positivism and interpretivism, as well as its relevance to natural and social sciences studies. Then, we will continue to explain that inductive reasoning, however, is rarely used in business and management research particularly in some of Indonesia's top higher education institutions. Furthermore, in order to show the importance of inductive reasoning, a case study of Starbucks and 7-Eleven in Indonesia will be presented with reflection to argument by Handy (1993). This paper will finally conclude by emphasizing the importance of inductive reasoning in business and management research and suggest future recommendations towards business and management research in Indonesia particularly on the higher education institutions.

Keywords: *inductive reasoning, future market challenges*

JEL Classification: *M31*



INTRODUCTION

There are basically two fundamental approaches in entailing a scientific conclusion which are known as deductive and inductive inferences. Okasha (2002) defined deductive reasoning as a process in which the premises entail the conclusion. However, inductive reasoning is defined as a process that begins with premises about objects that have been examined into conclusions about objects that have not been examined. Johnson (1996) provided some practical examples both in deductive and inductive reasoning. He provided deductive example as follows:

- P1 : All unmarried men are bachelors
P2 : Joe is an unmarried man
C : Therefore, Joe is a bachelor

The deductive reasoning mentioned above simply asserts that the given premises will entail the final conclusion. Whether the premises are true, it is of different issue and therefore does not reflect the status of the inference as deductive. Separately, Johnson (1996) mentioned that inductive reasoning is noticeably much richer and more complex. He asserted that inductive reasoning does not necessarily guarantee that the logical premises will finally form true conclusion. Take a look at the illustration given by Saunders and Lewis (2012):

- P1 : The first five eggs in the box were rotten
P2 : All the eggs have the same best-before date stamped on them
C : Therefore, the sixth egg will be rotten too

From the above illustration, the conclusion that is drawn from the set of logical premises seems plausible. Nonetheless, even though the first five eggs have been in such rotten conditions, it does not necessarily prove that the sixth egg will be rotten too; in fact, the sixth egg may possibly be in a perfect condition. Hence, by doing inductive reasoning, we can infer that even if the premises are true, the conclusion drawn may not be always true. Now, what is the relation between these scientific reasoning with the social and natural sciences? How is it linked with the philosophy of positivism and interpretivism?

Commonly, natural sciences use mainly the deductive approach – though it may begin with inductive observations – to look for causalities, in which the conclusion taken can be universally generalized. This is in line with the positivist philosophy which is highly



structured, measured – mostly quantitative – and mainly used in physical and natural sciences that can result in law-like generalizations (Saunders & Lewis, 2012). However, in social sciences, we cannot merely generalize and conclude human behavior as it indeed complex. Therefore, in studying social sciences, we argue that researchers shall be able to conduct the study based on interpretivism – commonly associated with inductive approach – rather than emphasizing on positivism approach, which is mostly associated with deductive testing. As a matter of fact, until the present time lecturers and researchers in some prominent universities in Indonesia – within the field of social sciences – has not yet appreciated and valued the importance of inductive reasoning (hypothesizing) in the business and management research, compared to studies with deductive (testing) method.

This paradigm is somehow supported by my personal observations and discussions carried out with several senior lecturers with more than 15 years of experiences in some higher education institutions in Indonesia. It is implied from the discussions that deductive approach is more common in business and management research compared to inductive method in these universities. Based on our study, many of the lecturers tend to assume that quantitative testing is easier to be understood than hypothesizing through qualitative studies. This widely spread understanding is in fact foolhardy.

To see why this is foolish, several supporting evidences will be presented. For example, inductive study from Handy (1993) that attempted to forecast the future of organizations have shown considerable impact in the way Starbucks has been operating lately (Schultz, 2011). A case study from Dieleman, Mahmood, and Darmawan (2015) regarding the inductive observation conducted in 7-Eleven Indonesia in the period of 2010 to 2013 will also be presented to support the argument.

Handy (1993) argued – by using inductive study – that there will be shifting in the way people look at organizations in the future. On this paper, we will focus on two paradigms stated by Handy. He wrote that the old paradigms, of which seeing organization as a property, and concentration plus specialization equals efficiency, will no more be relevant in the future. He also gave some sort of ‘clues’ to support his argument such as communication revolutions, ‘fees not wages’, ‘tools not machines’ and the economics of quality. Was his idea in 1993 relevant to the current management practices? In fact, as years passed by,



Handy's forecast is supported by Schultz (2011) as a CEO of Starbucks and Honoris as the CEO of 7-Eleven Indonesia (Dieleman et al., 2015).

In Schultz's book (2011) titled *Onward*, he simply explains that Starbucks – as an organization or business – does no longer sees its business some kind as a shareholders' property, but as a community which involves all stakeholders. These stakeholders involve the coffee bean farmers, baristas, customers, and their business partners. Schultz also clearly stated that Starbucks are at their best when they collaborate to provide a connection as well as a deep respect for the coffee and communities they serve (Koehn, McNamara, Khan, & Legris, 2014). Also on their website, currently Starbucks declares that they are living the value of “acting with courage ... to grow our company and each other” (Starbucks Corporation, 2016), which implies Starbucks' commitment to involve all stakeholders to grow together. Schultz continually listens to the customers, implemented generous employee benefits, and call their franchisees as ‘partners’. He also formed a Starbucks Open Forum for customers and employees of Starbucks to connect with each other.

In short, the above explanation has shown factual example of how Schultz as a CEO of Starbucks sees his organization. He does not rely mainly on the sole decision of shareholders to operate their business as a shareholders' property, but he has actively taken into account all stakeholders to contribute according their unique roles as a community to build common welfare in the society. Another sell-by-date paradigm which Handy argued is ‘concentration plus specialization equals efficiency’. This old paradigm declares that organizations must focus on the core capability and concentrate on specific product without having to take into account the idea of diversification towards markets' needs. The 7-Eleven case by Dieleman et al. (2015) will explain how this old paradigm may had been left behind and has shifted into a newer perspective.

Originally, 7-Eleven were first established as convenience stores in the United States in 1946 with original opening hours from 07:00 a.m. to 11.00 p.m. In Indonesia, 7-Eleven was first introduced in the 2009. The idea of convenience store at that particular time was just merely a small retail business that sells a variety of everyday items such as cigarettes, snacks, drinks, sweets, etc. Alfamart and Indomaret were recorded with the biggest shares in this particular industry with each 3.2 per cent and 3.1 per cent shares in 2013. Honoris, as the



CEO of 7-Eleven Indonesia at that time had some sort of difficulties in initiating his business since the local government of Jakarta had stopped issuing licenses for convenience stores as they feared that the traditional markets will be displaced. As an alternative, Honoris was told to focus on serving foods, tables, and chairs rather than regular concept of convenience store.

This challenge had become opportunity for Honoris as the CEO. Then, he tried to survey the customers to look for new insights and opportunities whether there are unfulfilled needs of the prospective target market. What he found based on his inductive market research was the lifestyle of ‘nongkrong’ among its potential target market. This ‘nongkrong’ can be loosely translated as a group of youth hanging outs to talk, use their phone, drink and eat (Dieleman et al., 2015). According to his findings, rather than concentrating and specializing on the regular concept of convenience store, he attempted to diversify the concept of an ordinary convenience store – that only sells daily items – to a store which combine convenience with free Wi-Fi, tables, chairs, and fresh foods to facilitate its target market’s unfulfilled behavior of ‘nongkrong’.

Joe Biedenharn as the business development manager of 7-Eleven Indonesia mentioned that compared to the average time of 7-Eleven customers spent in the United States – which maybe around 30 seconds – in Indonesia it can be almost one to two hours for a customer spent at a store. In addition to this, 7-Eleven Indonesia also developed what they called a central-kitchen that provided 60 to 70 per cent fresh food to their stores in Jakarta. Also, they introduce a new digital kiosk which enabled customers to purchase travel or entertainment tickets, taxi-calling service in partnership with Blue Bird, and even life and medical insurances. Within the period of 2010 to 2014, the sales of 7-Eleven Indonesia continued to increase with their distinctive strategies (Dieleman et al., 2015).

The above insights from Starbucks and 7-Eleven Indonesia have actually provided actual evidences that supported Handy’s inductive hypotheses (1993) regarding some of the sell-by-date paradigms in the way people see organizations. First, Starbucks have shown the management practices, in which Schultz applied, that organization is no longer seen as a property but a community of all stakeholders towards achieving common welfare. Secondly, 7-Eleven Indonesia case have provided contextual understanding of how the old paradigm – concentration plus specialization equals efficiency – does not apply in Indonesian market



environment. Nonetheless, 7-Eleven constantly adapt and diversify its business to fulfill its target market needs. Honoris also have shown his experience of how his inductive market research, surveyed towards the potential target market, can support his business to strive in the challenging times.

Based on the above explanations, it can be concluded that inductive reasoning can be defined as a research approach which involves the development of theory from a set of data or observations that were collected beforehand. Inductive reasoning is therefore highly important for business and management practices, particularly in marketing, as shown by two practical examples by Starbucks and 7-Eleven Indonesia delivered on previous paragraphs. Inductive reasoning can help businesses to gain new insights and opportunities both for the present time and in the future. Inductive reasoning can contribute to open new understandings, trends, and hypotheses in the business environment, compared to deductive approach which limits researchers to test only a set of given hypotheses.

The article of Evolving to a new dominant logic for marketing by Vargo and Lusch (2004), for instance, which has been cited for over 10.000 times is clearly an inductive study which attempted to gather and collect relevant and key information from the previous theories to make people aware regarding the outdated goods-dominant paradigm in the marketing studies. Their theoretically sound and grounded argument published in 2004 has in fact made scholars continue to discuss this service dominant logic until the present era.

Thus, it is recommended that higher education institutions in Indonesia need to shift their old paradigm by favoring and utilizing primarily more on deductive studies, compared to inductive studies which is arguably less popular in business and management research, that can actually help businesses to strive and respond in the future times. The old paradigm that relies heavily on deductive studies and statistical calculations in marketing studies must also be balanced with scholars who are able to analyze and build well-grounded arguments regarding the potential market changes and shifts in the future.



ACKNOWLEDGEMENT

The authors would like to extend sincerest gratitude towards Universitas Widyatama, Universitas Pelita Harapan and Professor Conrad William Watson for the support in the article creation process.

REFERENCES

- Dieleman, M., Mahmood, I. P., & Darmawan, P. (2015). 7-Eleven Indonesia: Innovating in Emerging Markets. Retrieved from Harvard Business School Publishing
- Ford, D. (1998). *The Dark Side of the Light Chaser: Reclaiming Your Power, Creativity, Brilliance, and Dreams*: New York: Riverhead Books.
- Handy, C. (1993). *Understanding organizations*: Penguin Uk.
- Johnson, C. F. (1996). Deductive versus inductive reasoning: A closer look at economics. *The Social Science Journal*, 33(3), 287-299. doi:[http://dx.doi.org/10.1016/S0362-3319\(96\)90024-5](http://dx.doi.org/10.1016/S0362-3319(96)90024-5)
- Koehn, N. F., McNamara, K., Khan, N., & Legris, E. (2014). Starbucks Coffee Company: Transformation and Renewal. Retrieved from <https://cb.hbsp.harvard.edu/cbmp/content/sample/314068-PDF-ENG>
- Okasha, S. (2002). *Philosophy of science: A very short introduction (Vol. 67)*: Oxford Paperbacks.
- Saunders, M. N., & Lewis, P. (2012). *Doing research in business and management: An essential guide to planning your project*: Pearson Higher Ed.
- Schultz, H. (2011). *Onward: How Starbucks fought for its life without losing its soul*: Rodale.
- Starbucks Corporation. (2016). *Our Starbucks Mission Statement*. Retrieved from <http://www.starbucks.com/about-us/company-information/mission-statement>. Retrieved from <http://www.starbucks.com/about-us/company-information/mission-statement>
- Vargo, S. L., & Lusch, R. F. (2004). Evolving to a new dominant logic for marketing. *Journal of marketing*, 68(1), 1-17.



**MARKETING STRATEGY ANALYSIS TO INCREASE THE GROWTH OF
OLAMITA RESTO**

Fadhil Fahmi

Master of Business Administration, Institut Teknologi Bandung

fadhil.fahmi@sbm-itb.ac.id

Abstract

Olamita resto is a unique restaurant that offers Gorontalo food to their customer. Olamita was founded by Mr. Ihsan Averoes Wumu, a young entrepreneur that was born in Gorontalo. Mr. Ihsan start his dream by opening Olamita resto in May 2015. Olamita resto is located at Jl. KH. Abdullah Syafi'ie No.51, Bukit Duri, Tebet, Central Jakarta.

Author start this research to analyse the growth of Olamita resto and give possible solution to the owner. The research method that is used by author is using both qualitative and quantitative method to get the best possible solution for Olamita resto. For the quantitative method, author go to the Olamita resto and analysing the current condition and interviewing the owner. For the qualitative method, author spread some questionnaire to Olamita resto customer in order to get their perspective.

This research have its conceptual framework to analyse Olamita resto from both internal and external aspects. Author use PEST analysis, Porter's 5 forces analysis, and competitor analysis to analyse the external factor. While for the internal factor, author use Marketing mix analysis, VRIO analysis, and Business model canvas.

The research result study of Olamita resto will be proposed to their owner as the strategy to increase the growth of Olamita resto.

Keywords: Marketing, Strategy, SWOT, Restaurant, Marketing Mix

JEL Classification: M31



INTRODUCTION

Background

Restaurant is one of the fastest growth in the Indonesian industry. In 2011 based on BPS statistic (BPS, 2012), there are 2.977 medium and big scale restaurant in Indonesia with average staff of 28 each. Restaurant that categorized with trade and hotel industry by BPS reach 8,11% growth in 2012 in gross domestic product without oil and gas industry. Restaurant, trade, and hotel industry growth is in the second fastest growth industry behind transportation and communication industry with 9,98% growth. In 2011 restaurant, trade, and hotel industry even get a faster growth with 9,17%.

The growth of restaurant business especially in Jakarta making lot of entrepreneurs making their own restaurant. The behaviour of Jakarta people that is very busy with their work making them got very few time on a day to do other things like cook their own meal. They prefer to eat in the restaurant so their time would not be wasted. But huge number of restaurant business in Jakarta also making a huge competition among the business. Restaurant business are now try to compete by offering a new experience in the service or with their food choice.

Olamita resto is a unique restaurant that offers Gorontalo food to their customer. Olamita was founded by Mr. Ihsan Averoes Wumu, a young entrepreneur that was born in Gorontalo. Mr. Ihsan seeing a huge prospect for Gorontalo food's market that has not been tapped especially in Jakarta. Born and raised as Gorontalo boy, Mr. Ihsan start his dream by opening Olamita resto in May 2015. With the help from both of his parents that are also born and raised in Gorontalo.

Gorontalo food is very famous with its Woku recipe that is spicy. Woku is by far the most favourite recipe of Gorontalo people. Most of Gorontalo's food is seafood that has lot varieties like Chicken and Fish Woku, Binte Biluhuta, Ilabulo, Milu Siram, Pilitode, Tili Aya, and many others. Gorontalo food share similarities with Manado's food, the difference is Gorontalo food are all halal while some Manado food is not halal. That factor is affected by the Gorontalo people that dominates by Muslim.



Olamita is now running its operation everyday from Monday to Sunday 09.00 until 21.00, except in Sunday Olamita started to open from 12.00 due to closed road for “pasar tumpah Tebet” in front of Jl. KH. Abdullah Syafi’ie in the morning. Mr. Ihsan have 9 employees to run Olamita with most of the employees are unskilled except the chef. The employees consist of 1 chef, 5 operational employees, 3 waitress, and 1 cashier. The chef of Olamita is Gorontalo’s born, he do almost all the cooking by himself while most of the operational employees are helping the chef to cook, also stocking the ingredients needed. The Olamita employees are work in daily shift to fit 7 days per week schedule.

Problem Formulation

Since the beginning of opening until now, Mr. Ihsan is satisfied with the overall business performance of his Olamita resto. The employees that led by the chef already able to perform their daily job automatically, even though some employees are resigned in the past months which still considered to be normal for unskilled worker to move from one work to another in short time and it still can be handled well by Mr. Ihsan. The satisfaction of the customer to the food also very good from the customer feedback and the repurchase retention they make, thanks to skilled chef from Gorontalo. However, Mr. Ihsan feels the customer growth of Olamita resto is too slow. Mr. Ihsan observing the number of Olamita resto visitor is still too low and fluctuative without a significant growth. After 5 months of running his business, Mr. Ihsan see the revenue data of Olamita resto and the revenue data confirm his observation.

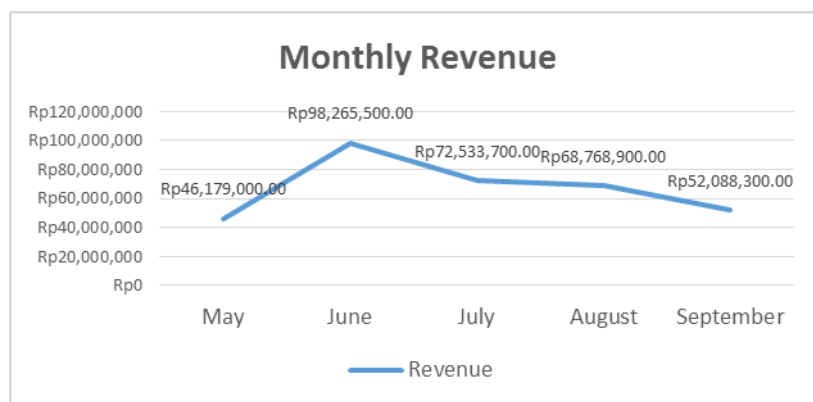

Figure 1. Olamita Resto Monthly Revenue



From data above we can see that the monthly revenue trends of Olamita resto are declining. The monthly revenue and daily average revenue of Olamita resto only enjoyed one incline during month of June. Olamita resto get a revenue of Rp. 94,265,500 and average of Rp. 3,275,517 on that month, because on June Mr. Ihsan inviting a lot of Gorontalo people to try Olamita resto by using word of mouth and direct invitation of his inner circle contacts. The promotion proven to be successful because most of the invited person are coming with their family or colleagues. However the effect of this promotion only last for one month. During July until August months Olamita resto revenue come back to normal value once more.

Mr. Ihsan is now in the brink to invest some money for marketing of his Olamita resto, but he cannot decide which kind of marketing strategy that he need to use to boost the customer of Olamita resto. The budget for the marketing expense is not much, so Mr. Ihsan must choose the most suitable one that can bring the biggest impact among other. He is now need help to find out what marketing strategy can make the more customer go to Olamita resto that has a unique and unfamiliar food where most of the people don't even know what Gorontalo food is.

A research to the market are needed to solve Mr. Ihsan dilemma in order to pick the correct marketing strategy and avoiding a potential failed promotion of Olamita resto. Writer are trying to help Mr. Ihsan by creating this research to grow Olamita resto. Writer hope the result of this research will give Mr. Ihsan a guideline of what marketing strategy to use and the implementation.

LITERATURE REVIEW

Conceptual Framework

Conceptual framework is created to get a good structure of analysis that will resulting on a business strategy formulation and implementation. The conceptual framework will help Olamita resto's research to be on track, analyse the right things, and getting the desired result.



First step of the conceptual framework would be defining a problem statement and then followed by creating a research objective. Both of the problem statement and research objective of Olamita resto's research is already discussed on previous chapter. Next step of the research would be business issue exploration that will be discussed on this chapter. Business issue exploration will analyse the business which is Olamita resto in this case by observing their internal and external factors using several tools and theories. Tools and theories for internal analysis are marketing mix, business model canvas, and VRIO analysis. While for the external analysis, author will use PEST, porter 5 forces, and competitor analysis.

After finished with business issue exploration, the research will continue with business strategy formulation which will use SWOT analysis to conclude the previous chapter analysis plus other data from the research. Last step of the conceptual framework would be giving conclusion and recommendation to the business in this case is Olamita resto. The implementation plan would be the final form of the conclusion and recommendation chapter.

This research will use and gather data for analysing all aspect of the business. Author will gather data using 3 methods in this research. First is data from Olamita resto's owner interview, second is questionnaire data, and last data is from author's analysis.

RESEARCH METHOD

Methodology

A questionnaire about Olamita resto with 19 questions are distributed to the customer to gather data about the every Olamita resto aspects especially in their marketing mix by either giving a score or filling multiple choice questions. The target of respondents are 100 person in order to get a reliable and precise data about Olamita resto. The sampling methodology is using random sampling method to Olamita resto visitor. All of the respondents must already try Olamita resto at least once, so the questionnaire were spread in Olamita resto to random visitors. Cronbach Alpha's method is used to determine the reliability of the data, the Cronbach Alpha's result for this questionnaire is 0.976 which is



very good. The questionnaire part can be categorized into 3 section which are demography, general restaurant question, and 7P's questions.

RESULT AND DISCUSSION

Demography Result

First part of the questionnaire is about the demographic of the respondents. There are 4 demographic questions to group the respondents based on each category. Those 4 categories are gender, age, expense per month, and domicile. Demographic question will also be useful to map the background data of Olamita resto customers.

Based on the gender, respondents are 57% male while 43% of them are female. The author try to make a balanced ratio of male and female respondents since Olamita resto is not specifically target one of the gender. This ratio is considered to be balanced with only small different in number between male and female respondents.

Respondents of the questionnaire age are divided into 3 age range. First is 17-24 years old respondents which is 41%, second is 25-34 years old respondents which is 45%, while the last one is 35-44 years old respondents which is 14%.

Expense per month of respondents are varied, majority of the respondent's expense per month ranging from 1,5 million to 3 million with consist 37% of total respondents. 22% respondents spend 3 million to 4,5 million per month. Both category expenses of 4,5 million to 6 million and more than 6 million have 19% respondents each. While the minority of 3% spend less than 1,5 million per month.

Last demography question is about domicile of the respondents. Most of the respondents is from Jakarta with 75% of total, this domination is because Olamita resto located in Tebet, Central Jakarta. While the rest 10% live in Tangerang, 6% in Bekasi, 5% from Depok, and 4% respondents live in Bogor.

General Restaurant Result

Second part of the questionnaire is about general restaurant question. This part have 8 questions about general restaurant aspects. The question of general restaurant part are consist



of restaurant visit per week, halal menu, reason try a new restaurant, social media, restaurant information source, preferred promo, Manado food, and Gorontalo food. General restaurant question will be useful to give an insight about how a customer behaviour toward restaurant in general.

Restaurant visit per week data is dominated with answer of 1-2 times visit per week with 52% respondents. While 36% respondents coming to restaurant 3-5 times a week. 7% of the respondents is coming to the restaurant 6-8 times per week. The minority of 5% respondents is coming to a restaurant more than 8 times a week.

Next question is about how important is a 100% halal menu towards customer preference over a restaurant. Majority of 73% respondents agree that 100% halal menu in a restaurant is become one of their concern on choosing a restaurant. While the other 27% of respondents choose the opposite answer.

Respondents are asked about their reason when try out a new restaurant. 32% respondents says that they try a new restaurant because friend recommendation, 17% because of food blogger review, 14% because of fancy restaurant design, 14% because of the promo, 17% because it is viral in social media, 4% because its flyer and banner, and 2% because of other reason.

Respondents have variety of most effective promotion media for a restaurant. 38% respondents choose social media, 3% choose flyer, 5% choose banner, 9% choose blog, and 1% choose other. But most of the respondent believe that word of mouth is the most effective promotion media for a restaurant with 44% of the answers.

Next question is about the media choice of respondents when looking for restaurant information. 14% respondents choose Qraved as their guidance. Both of Zomato and Instagram food account get 32% vote each. Respondents also choose food blog with 7%, Google directory with 13% and other media with 2% vote.

Next is about the respondent's preferred promo on a restaurant. 40% respondents choose 20% discount as the best promo a restaurant could offer. 11% choose get free drink, 33% choose combo set, 13% choose get free side dish, 2% choose free food after 5 times purchase, and 1% choose other promo.



Next, respondents is asked about their familiarity with Manado food. 60% of the respondents answer that they are familiar with Manado food, while the other 40% is not familiar with the Manado food.

Last, respondents are asked about their familiarity with Gorontalo food. The answer is 86% of the respondents are not familiar with Gorontalo food, while the rest of 14% respondent says that they are familiar with Gorontalo food. From this result we can understand that even people that have been visit Olamita resto, most of them are still not familiar with Gorontalo food.

Marketing Mix Result

The third part of the questionnaire is about 7P's of Olamita resto. This part have 7 questions with each of them will represent each of the P on marketing mix. The Promotion aspect will use multiple answers, while the other 6 P will use linear scale from 1 (very not satisfied) to 5 (very satisfied). The reason of promotion not using linear scale because Olamita resto have not start any promotion to the public before this research begin. Below is the marketing mix result.

First, respondents are asked to rate Olamita resto menu based on their recent visit. This aspect get mean of 4.65 which is the highest rank among others. Olamita resto get very satisfied score from 67% of the respondents. The 31% respondents answer satisfied with Olamita resto menu. While there are 2% of the respondents that rate Olamita resto menu on the neutral point. Respondents are very satisfied with the Olamita resto menu, taste and freshness which is a great job.

Next, respondent rate the pricing of Olamita resto. Pricing of Olamita resto get mean score of 4.3 which is the 4th highest among other aspects. The majority of 48% respondents says that they are very satisfied with the pricing of Olamita resto. Additional 35% respondents also says they are satisfied with the pricing. 16% respondents choose to rate neutral price and 1% respondent is not satisfied with the price. It can be concluded that Respondents are already satisfied with the price range that offered by Olamita resto.

Service aspect of Olamita resto also get positive feedback from the respondents. The service of Olamita resto get a mean score of 4.48 which is the second highest. Majority of



54% respondents are very satisfied with the service provided, while the other 41% respondents are also satisfied with the service. 4% respondents choose to rate neutral and 1% respondent not satisfied with the service.

Location aspect of Olamita resto however, get a bad rating from the respondent. Location only get the mean score of 3.3 from respondents which is the second lowest among other marketing mix aspects. Majority of 45% respondent choose neutral for the location of Olamita resto, but 29% believe Olamita resto location is not strategic followed by 1% that choose very not strategic. The rest 23% choose strategic location and only 2% respondents choose very strategic location. Respondent are very not satisfied with the location of the Olamita resto especially the access that pretty not strategic for customer with personal transportation.

Decoration and hygiene of Olamita resto also get unsatisfactory review from customer. Decoration and hygiene got the mean score of 3.3 which is the third lowest. Majority of 63% respondents rate neutral for Olamita decoration and hygiene, plus 5% respondents choose not satisfied. 29% respondents satisfied with decoration and hygiene and the rest 3% choose very satisfied. The respondents are not impressed with the decoration and hygiene of Olamita resto, respondents are demand something more in this aspect.

Next aspect of the questionnaire is the speed of service of Olamita resto. Speed of service got mean score of 4.33 which is the third highest. 40% respondents are very satisfied with Olamita resto speed of service. Majority of 53% respondents rate Olamita resto speed of service are satisfied. The rest of the respondent choose to be neutral in speed of service aspect with 7% vote of the total. Respondents are also giving a positive review for the speed of the service in Olamita resto when they ordering the menu.

Last Marketing mix's question is about the promotion of Olamita resto. For promotion aspect, the question will not use linear scale because the lack of promotional activity by Olamita resto before this research begin. Olamita resto only use signage, banner that located right outside the store and SMS for the regular customer. With that fact, author decided to not ask respondents giving score for this aspect. Respondents are asked about how they know Olamita resto and majority of 48% respondents said that they know Olamita resto from friend tips. Surprisingly, despite the lack of promotional activity 28% respondents know



Olamita resto from the social media this could be because some people posted Olamita resto on their personal social media. 17% respondents know Olamita resto when they pass by, 3% from Olamita resto banner, 2% from Olamita resto flyer, and the rest 2% know Olamita resto from other media. Since the lack of promotion activity by Olamita resto, author decided to put the promotion aspect in the lowest rank in the marketing mix and will develop a new strategy for promotion activity for the future based on above diagram.

After analyse the data about Olamita resto marketing mix above, we can now put two categories for all aspect. First category is for aspects with mean score more than 4.0 which means respondents already satisfied in this aspects. There are 4 aspects of Olamita resto's marketing mix that include on the first data category which are Menu, Service, Speed of Service, and Price. Olamita resto can keep up their work in these aspect or making some small changes to improve the aspects further.

While in the second data category which is Olamita resto's marketing mix that has mean score less than 4.0 which means respondents demand for some improvement in the future. There are 3 aspects of Olamita resto's marketing mix that fallen into this category which are Decoration & Hygiene, Location, and Promotion. These 3 aspects is rated non-satisfactory by the respondents, therefore Olamita resto must now focus to make a new or change the strategy of the aspects.

Business Solution

Based on the questionnaire data that already presented above, author will try to find out the best business solution that suited current condition of Olamita resto. Author will now decide what strategy that is the best and suited the condition of Olamita resto the most. Strategies developed in this chapter will be covered by using tools and theories. Some tool and theory already reviewed in the previous chapter, but in this chapter that tools and theories will be developed based on the questionnaire and research result to make a better strategy for Olamita resto. While there are also new tools and theories to be developed for Olamita resto strategy. The tools and theories that is used to develop business solution of Olamita resto are SWOT, marketing mix, STPD and business canvas.



SWOT

Strengths

According to Humphrey (1970) strength is the aspect that have most power in a company compared to the industrial they pursue. It is the characteristics of the business or project that give it an advantage over others. Based on research result, there are 5 aspects of Olamita resto strengths. First is the unique product of Olamita resto which is the Gorontalo food. Not only the product is unique, research result also states that the product of Olamita resto get a very good ratings from its customers. Second strengths of Olamita resto is they currently the only resto to offer Gorontalo food in Jakarta. Since Olamita resto is the only restaurant that offers Gorontalo food in Jakarta, they don't have to worry competing with similar product at least for now.

Third strength point of Olamita resto is the owner's connection with Gorontalo people. Since Mr. Ihsan is Gorontalo born and his parents is well known among Gorontalo people, he is able to invite Gorontalo people that live in and visiting Jakarta. The owner even relying in this connection strategy during the beginning of Olamita resto opening and it is proven to generate a good number of revenue in that period. Fourth advantage of Olamita resto is the chef that has a broad knowledge of Gorontalo food. Olamita resto relying on its food's uniqueness and quality for attracting customer. The impact of this strategy is the chef ability and skill would become very crucial for the resto operation. Luckily Olamita resto has a good chef that is also Gorontalo born and have speciality in Gorontalo food. Mr. Ihsan also get some tips from his mother for some kind of food that help Olamita resto offer and maintain good and tasty food to its customer. Last strength of Olamita resto is their price and service. From the research result it is found that customer is so satisfied with the price range of the menu and the service provided by Olamita resto. In previous chapter reviewed that Olamita resto price range is the lowest among their competitors. While the service aspect, the good ratings from customer could be achieved because of the proactive of owner to greet the customer every time he available on the Olamita resto.



Weaknesses

Humphrey (1970) said that weaknesses is the aspect that prevent a company to reach its maximum level of general business operation. It is the characteristics that place the team at a disadvantage relative to others. . Based on research result, there are 5 aspects of Olamita resto weaknesses. First and foremost is the non-strategic location of Olamita resto. Based on the research result, location get a bad rating from the customer because the difficulty to access Olamita resto. The customer of Olamita resto is forced to do double U turn from Kasablanka, while customer from the opposite road must do one U turn. This problem causes by the newly closed road for railroad just before the Olamita resto. The traffic after office hour also makes the trip to Olamita resto would be too tiring for some customer that makes some of them cancel their plan to visit.

Second weaknesses of Olamita resto is the product is not well-known. Olamita resto do offer a unique and tasty product to its customer, however based in research result most customer is not familiar with Gorontalo food. Since restaurant that offers Gorontalo food is almost none in Jakarta and any other cities, this problem is normal. Olamita also don't give any teaser for the customer in front of their store that make the matter worse. Third weaknesses of Olamita resto is the lack of promotion from the owner. The promotion strategy of Olamita resto is only by put banner and signage in front of their store, plus sending SMS to the regular customer. This strategy simply not enough for a restaurant that looking for a traction during their beginning period. The owner strategy of promotion only by inviting his inner circle of Gorontalo people to visit Olamita resto. This strategy is successfully give good revenue to Olamita resto for only two months of their opening.

Next weaknesses point of Olamita resto is the poor hygiene and decoration in their store. Research result says that the customer is unsatisfied with Olamita resto hygiene and decoration. The owner himself says that he is not very concern about Olamita resto hygiene except for the food material and processing. While for the decoration, Olamita resto only put many handwritten testimonial in a framed piece of paper in every side of the wall which is not very aesthetic. Last weaknesses of Olamita resto is the lack of SOP in the process. Mr. Ihsan relying on their worker to get things done without any standard. Most of the time, some



job like purchasing and food stocking is not done in neat process. The staff is waiting for owner or chef order to do things.

Opportunities

Opportunities is one out of two external factors in SWOT analysis. Humphrey (1970) says that opportunities is the possibility of a company to widen or strengthen their existence in the market by taking some strategic move, usually this move will make the company generate more profit. Based on research result, there are 4 opportunities for Olamita resto that can be explored. First opportunities for Olamita resto is looking for supply a meeting or event. Since the non-strategic location of Olamita resto, the owner could try to use this strategy for boosting the sales of Olamita resto. Last November, Olamita resto got a catering order for political event. Olamita resto could also try to aim for Gorontalo's event catering in the future that always held during Ramadhan.

Second opportunity for Olamita resto is to open new stores. Olamita resto can open Olamita resto in other location, however this plan is still too early at least for now since the current location of Olamita store is still non-strategic. However after figuring out all of their problem and growing a good revenue from current store, Olamita resto can start to think about opening a new store in other location. Next opportunity for Olamita resto is to do franchising. Olamita resto can open a new store by using franchising method to minimize the capital required. But same as the previous opportunity, this one is also more likely to be executed in the future with a clear SOP needs to be figured out first.

Lastly, the opportunity for Olamita resto is to offer more promotional campaign. To attract more customers, Olamita resto could try to start offer promotional campaign. The promo could be in form of discount, free food, or any other kind. Olamita resto also need to be more aware about upcoming event to create a suitable and attractive promotional campaign. By using a good and correct promotional campaign, Olamita resto could gain more revenue.



Threats

Threats are the second external factors of SWOT analysis. Humphrey (1970) was implied that threats is a condition when company has some factor that can bother and reduce their working performance. Threats are uncontrollable, it will affect the stability and survival of the company will be at stake. Based on research result, there are 4 threats for Olamita resto that owner must be aware of. First threat is the easily imitated product of Gorontalo food. Olamita resto offer a unique and good product to its customer and currently have no other restaurant offer the same food. However things could change if Olamita resto get successful. Because it is pretty easy for competitor to offer Gorontalo food, there are almost no difficulties for them to enter this business.

Next threat for Olamita resto is the possibility of hijacked chef. Since most of the Olamita resto's product is made by their chef that has broad knowledge of Gorontalo food, hence he become one of the key aspect. However, there is a possibility this chef could be hijacked by other restaurant or even open his own resto. Third threat of Olamita resto is high number of employee turnover. Most of the Olamita resto employee is unskilled worker and paid below the standard salary. The impact is the possibility of high turnover rate of the employee, once the underpaid employee found a better paid job there is no reason for them to be loyal to Olamita resto. Last threat of Olamita resto is new restaurant opening nearby. Just 5 building after Olamita resto, there is a brand new restaurant that offers chicken menu. The close location of this resto can make the market shares of Olamita resto reduced because of the competition with this new restaurant.

Marketing Mix

Product

Product of Olamita resto fall into first category in their marketing mix result with average score of 4.65 from the customer and become the highest rated aspect. As stated in the previous chapter, Olamita resto is offering Gorontalo food to the customer. Gorontalo food are mostly seafood with special flavour of Gorontalo spices. Gorontalo food is very similar with Manadonese food that already popular and spreaded throughout Jakarta with the main



difference being the halal label. Gorontalo menu offer 100% halal food, while not all of the Manadonese food are halal.

The things that can be improved by Olamita resto in terms of product is to make customer more familiar with it. Based on the research result, only 14% respondent are familiar with Gorontalo food. The menu of Olamita resto also has unfamiliar name like Fish Woku, Goropa Bilenthango, Pilitode Lobuyu, Ilulia Fish Oci, Ilahe, and many others. Olamita resto can help the customer by putting details of the ingredients right below the menu name to help customer choosing the food.

Place

Place aspect of Olamita resto fall into the second category in research result with average score of 2.96 which is the second lowest. Olamita resto are located in Jl. KH. Abdullah Syafi'ie No.51, Bukit Duri, Tebet, Central Jakarta. The location should be pretty strategic, however the road are recently closed for rail track only, car and motorcycle should use the bridge with exit located after Olamita resto, the consequences is customer that come from Kasablanka road must do double U-turn to get to Olamita resto.

Olamita resto is suggested to find a more strategic place after finishing 2 years contract on current location. For now, Olamita resto can try to resolve this problem by looking some opportunity from events. Olamita resto can offer for catering services for events to boost their sales. Olamita resto can also try to improve the demand from their delivery service by making a proper packaging like box for the delivery services. Olamita resto can try encourage their customer to try delivery service using their delivery partners Go-Jek, Uber Eats, and Grab Food.

Price

Price aspect of Olamita resto fall into first category in the research result with average score of 4.3 which stand in the fourth rank among other marketing mix. As stated in previous chapter, Olamita resto's food price range are offered from Rp. 20.000,- until Rp. 60.000,- for the most priciest one. Most of the menu in the Olamita resto are served for 2-3 person for group dine. The special seafood menu like Goropha Bilenthago and Cakalang Fufu Rica are



priced Rp. 50.000,- while the the regular seafood menu like Ilulia Fish Oci and Tilumiti Fish Oci are priced at Rp. 20.000,-.

For the price aspect, Olamita resto no need to do any improvement since their price is already lower than the competitors. Olamita resto competitors like Beautika and ROA set a more expensive price that ranging from Rp. 35.000,- to Rp. 65.000,-. Olamita resto can just put their focus on pricing strategy for the promotional activities to get more traction from their customers.

Promotions

Promotion aspect of Olamita resto fall into the second category that also need improvement. Promotion aspect is in the lowest ranking of all marketing mix because of the lack activities of it by the owner. Olamita resto currently only have very few promotion media like signage, banner, and SMS blast for promoting the business. The reason Olamita resto only have few promotions media is because Mr. Ihsan still don't know the best form of promotion for his restaurant.

Olamita resto need to improve their promotions activities to reach more customers. From the research result it is found that the top 3 reason to try a restaurant are friend recommendation, viral in social media, and food blogger review. Olamita resto must start do those things to improve their promotion. First, Olamita resto must start to do promotions in social media like Instagram, Twitter, and Google directory. Food blog like Qraved and Zomato is also a good promotional media based on the research result. Olamita resto is also suggested to do some promo like 20% discount, combo set, and get free side dish to attract more customers to visit Olamita resto.

Physical Evidence

Physical evidence aspect also fall into the second category in the research result with average score of 3.3 which is the third lowest aspect in their marketing mix. As stated before, Olamita resto have a traditional restaurant design. The interior of Olamita resto are very simple with 12 tables that can serve up to 25 peoples. The place are decorated with photos and testimonial from well-known Gorontalo people that already visit Olamita.



The problem with Olamita resto physical evidence is the design of the store itself. Store design of Olamita resto way too simple and not even aesthetic. Mr. Ihsan must try to improve the design of the store by asking for recommendation from an interior designer. Olamita resto also need to make sure about the hygiene of the store since customer is not impressed with the current condition of store hygiene.

People

People aspect of Olamita resto fall into first category in the research result with average score of 4.48 which stand in the second rank among other marketing mix. As the previous chapter has reviewed, Mr. Ihsan have 9 employees to run Olamita resto with most of the employee are unskilled worker except for the chef. The employees consist of 1 chef, 5 operational employees, 3 waitress, and 1 cashier. The chef of Olamita resto is Gorontalo's born, he do almost all the cooking by himself.

Things that can be improved for this aspect is by giving some uniform to the front desk staff in order to create a neater vibe in Olamita resto. By giving uniform to the front desk staff, customer can easily differ the employee from the fellow customer. The impact of giving uniform also bring a better image from customers of Olamita resto.

Process

Process aspect of Olamita resto fall into first category in the research result with average score of 4.33 which stand in the third rank among other marketing mix. Based on the previous chapter, daily operation of Olamita resto is still conventional and supervised directly by Mr. Ihsan. Customer will be gather with waitress or the owner when they first arrived. Food processing is located in closed kitchen traditionally with minimum level of quality control. The payment still using written bill however all the order are taken with tablet for the point-of-sales substitution.

Things that can be improved in process aspect of marketing mix by Olamita resto is creating a SOP for daily operation standard. By having SOP and make sure all of the employee follow it everyday, the operation in Olamita resto will always run smoothly even



without direct supervision of the owner. SOP will make every staff have a clear job desk and know what and when to do their job.

S, T, P & D

Segmenting

Segmenting is the process of defining and subdividing a large homogenous market into a clearly identifiable segments that having similar needs, wants, or demand characteristic. After that, the business must try see the potential of serving needs, wants, or demand of the chosen segment. This is the first step when defining S, T, P & D of a business.

Olamita resto segmentation could be defined using the expense criteria and visitor criteria. For the expense per month criteria, Olamita resto could choose to serve either low expenses customers, middle expenses customers, or high expenses customers. Olamita resto should also choose to target customers based on the visitor criteria. Olamita resto can choose to target either families, youth & teenagers, couples, employees group, or mixed between all. Those two are the segmentation of Olamita resto.

Targeting

Targeting is selection process of potential customers to whom a business would sell their product or services based from the segmentation of customers with similar needs, wants, or demand. A business can either choose one specific segment to target or serve each segment by offer a different product or service to each of the target. For Olamita resto, the most possible to do is choose one of the segment and focus to target that specific market. Targeting is the second step of defining a business S, T, P & D.

Based on the research, the majority of the Olamita resto customer come from middle to high expense that ranging from Rp 6.000.000 until more that Rp 1.500.000 per month. So Olamita resto is suggested to target medium to high expense per month customer. This target market also fit with the pricing strategy of Olamita resto that is cheaper compared with their competitors. Based on the visitor criteria, Olamita resto should target employees group combined with family dining. Based from the observation, most Olamita customers are



employee that visiting during break or after office hour. These customers also coming back during weekend to eat with their families.

Positioning and Differentiation

Last step of S, T, P & D is defining a business positioning and differentiation. Positioning itself is an effort to influence consumer perception of a brand or product relative to the perception of competing brands or products. While differentiation itself is a promotional method employed by a business to create an especially strong presence in a particular market. Positioning and differentiation is affecting each other, a good differentiation would help a business create its positioning on the market.

The best positioning statement of Olamita resto is “home of Gorontalo food”. These positioning statement make Olamita resto as the only restaurant to serve traditional Gorontalo food in Jakarta. Olamita resto’s differentiation help them to create a clear positioning statement than their competitors. The differentiation of Olamita resto is their product of Gorontalo food which currently is the only one available in Jakarta.

Business Canvas

Value Proportion

The previous chapter’s value proportion of Olamita resto and the first and only available Gorontalo resto in Jakarta and Olamita resto offer a fresh Gorontalo’s fish that has unique taste. However, the better suited value proportion of Olamita resto is home of Gorontalo food. Since Olamita resto is the only Gorontalo resto in Jakarta, they can claim as the home of Gorontalo food by bring the unique food of Gorontalo to the customers.

Customer Relationship

Current customer relationship of Olamita resto are by giving discount to the regular customers and having personal chat with the owner himself Mr. Ihsan. Owner also sometimes sending personalized message to regular customers. The proposed customer relationship of Olamita resto is by giving discount for social media post by customers. With customers



posting Olamita resto in their social media, Olamita will give discount but in the other hands get promotion from their customers. Olamita resto can also do social media promo to their followers for gain customer traction.

Channels

Previously, Olamita resto are using banner, signage, and SMS to reaches and promoting their value proportion to its customer. Those channels is not enough for Olamita resto to gain customers. They need to start use social media channels like Instagram, Twitter, and Google directory for reaching more customers. Olamita resto also need to put their resto information in Qraved and Zomato in order for customer can know more about their menu.

Customer Segments

Olamita resto are currently targeting family and group customers, specifically Gorontalo people that live in Jakarta. However research result shows that their customer segments is not family and Gorontalo people, because this two segment only represent small part of Olamita resto customer. Their customer segments are 17-45 years old people with most of them work as employees and live on Jabodetabek area. Customer segment of Olamita resto are having medium expense.

Key Partners

It is previously stated that the key partner of Olamita resto are local market for supplying all of the ingredients needed and Gorontalo's fish market for some kind of special fish menu. It is proposed that Olamita resto must add Go-Food, Uber Eats, and Grab Food as these three can contribute revenue to Olamita resto using their delivery services. Zomato and Qraved should also added to their key partners for giving information to their customers.

Key Activities

Olamita resto key activities are almost the same with other restaurant business like daily operation like cooking and serving, marketing activities like creating promotions, and



the latest one is doing quality control to the food. For key activities aspect, Olamita resto do not need any changes.

Key Resources

In the previous chapter, key resources of Olamita resto are likes unique recipes of Gorontalo food, location that considered pretty strategic, and also the Gorontalo connection that Mr. Ihsan have to approach Gorontalo customers. However, research result shows that the location can't considered as key resource as customers believe Olamita resto located in non-strategic location. Chef of Olamita resto should also be added to the key resource as he is one of the important element in this business.

Revenue Streams

Previously, revenue streams of Olamita resto is only generated from the daily sales of the restaurant. However Olamita should start generate revenue from other type of sales. First suggestion of additional revenue stream is from event sales. Olamita resto should try to sell their product on events outside the store because of the unstrategic location problem. Recently, Olamita resto successfully supply the catering for a political event. Second proposed new revenue stream is from delivery service. Olamita resto should also try to generate more revenue from the delivery service.

Cost Structure

Last aspect of marketing mix is Olamita resto's cost structure which comes from the operational cost of making the food and hiring the staff plus marketing cost of promoting the Olamita resto to the target market. This aspect also do not need to be changed since it is already suit well.



CONCLUSION AND IMPLEMENTATION

Conclusion

Olamita resto has huge potential to become a good and profitable business. They got a unique product that supported by a talented chef and hard work of Mr. Ihsan. However, things still have not going as their planned. Olamita resto still struggled to generate a healthy number of revenue.

Olamita resto have a good strategy from their owner. In spite of that, their current strategy still need some improvisation from the owner in order to generate more revenue. This research result already give some insight to the owner about what aspects that still require major improvements and what aspects that only need to be maintained or get some minor improvements.

This research divide each aspects based from Olamita resto's marketing mix. As a restaurant business that giving service to their customers, Olamita resto's marketing mix is having 7Ps instead of conventional 4Ps. From 7 of those Olamita resto marketing mix Ps, 4 of them which product, price, people, and process are fall into the first category that only need to be maintained. While the other 3 which place, promotions, and physical evidence are fall into the category that need major improvements.

Implementation

In order for Olamita resto to execute all of the recommendation from this research, an implementation plan must be developed. The implementation plan is useful to make sure all of the recommendation from the research can be implemented into a real strategy. Implementation strategy of Olamita resto will also give some list of to do things for the owner. Below are the implementation strategy for the Olamita resto to improve their business.

- Make social media account
- Manage Olamita resto online information
- Put food information details on the menu
- Start promo campaign to get traction
- Generate income from event sales
- Create delivery service package



- Re-decorate the store
- Ensure hygiene of the store and products
- Move the store to more strategic location

Implementation Timeline

The implementation strategy for Olamita resto need to be executed with a timeline order. The timeline window of this implementation strategy is from January 2017 until April 2018 when the contract of the Olamita resto location end. Each of the task on the implementation strategy are marked during the month it should begin the execution until the task can be executed regularly. Below is the implementation strategy timeline of Olamita resto.

Task	2017												2018				
	Ja n	Fe b	Ma r	Ap r	Ma y	Ju n	J ul	Au g	Se p	Oc t	No v	De c	Ja n	Fe b	Ma r	Ap r	
Make social media account																	
Manage online information																	
Menu information details																	
Start promo campaign																	
Event sales																	
Create delivery package																	
Re-decorate the store																	
Ensure Hygiene																	
Move to new location																	

Figure 2: Olamita resto Implementation Timeline



REFERENCES

- Cravens, David W., 1982, *Strategic marketing*. Homewood, Ill.: R.D. Irwin.
- Hitt, Michael A., R. Duane Ireland, and Robert E. Hoskisson., 1999, *Strategic management: competitiveness and globalization*. 3rd ed. Cincinnati: South-Western College Pub.
- Indonesia Investments, 2016, Corruption in Indonesia. Retrieved on October 13, 2016 from <http://www.indonesia-investments.com/business/risks/corruption/item235>
- Indonesia Investments, 2016, General Economic Outline of Indonesia. Retrieved on October 13, 2016 <http://www.indonesia-investments.com/culture/economy/general-economic-outline/item251>
- Kotler, P. & Keller, K.L., 2000, *Marketing Management*, Prentice Hall.
- Management Study Guide, 2008–2013, *Porter's Five Forces Model of Competition*. Retrieved on July 29, 2013 from <http://www.managementstudyguide.com/porters-model-of-competetion.html>
- Osterwalder, Alexander, Yves Pigneur, and Tim Clark., 2010, *Business model generation: a handbook for visionaries, game changers, and challengers*. Hoboken, NJ: Wiley.
- Porter, M.E., 1998, *Competitive Strategy: Techniques for Analyzing Industries and Competitors*, Free Press.
- QuickMBA, 1999-2010, Porter's Generic Strategies. Retrieved on November 29, 2016 from http://www.tutor2u.net/business/strategy/porter_five_forces.html
- Tutor2u, 2016, Porter's Five Forces Model: analysing industry structure. Retrieved on November 29, 2016 from http://www.tutor2u.net/business/strategy/porter_five_forces.html
- Wheelen, Thomas L. & Hunger, J. David, 2008, *Strategic Management and Business Policy*, New Jersey: Prentice Hall.



**PREMIUM FRESH PRODUCE MARKETING SUCCESS FACTORS THROUGH
PRODUCT QUALITY DIMENSIONS AS CUSTOMER DRIVING FORCES: A CASE
STUDY OF FRUIT SPECIALTY STORE PRODUCT DISPLAY OPTIMIZATION IN
BANDUNG**

Hesty Nurul Utami

Agriani Hermita Sadeli

Department of Agro Social Economics, Faculty of Agriculture, Padjadjaran University

hesty.nurul@unpad.ac.id

agriani.hermita@unpad.ac.id

Abstract

This study try to give a new insight of how fresh fruit specialty store utilize product quality as their business success strategy and drive the customer to give concern on premium product that offers at store.

The study apply qualitative method with case study research design. Since the study propose to elaborate and determine the existing phenomena, the application of descriptive research design used to describe comprehensive insight of fresh fruit product quality dimensions provision in specialty store and its distribution mapping along with marketing product strategy of premium apple fruit. Data obtained through direct interview to key informants from specialty store managements who have role to the provision and marketing of premium fresh apple in the store with judgmental sampling technique along with observation that used as primary data of the study.

The study found that product supply on premium fresh apple that imported from China to Indonesia and sold at fruit specialty store based on distribution and supply chain description can be seen as structured market format with horizontal supply chain type of short food supply chains (SFSCs).

Keywords: *premium fresh produce marketing, business success strategy, fruit specialty store product display optimization in Bandung*

JEL Classification: *M31*



INTRODUCTION

Fresh produce market retailing has shown dramatically change this recent years including in developing country such as Indonesia. The development of modern market retail show rapid growth that even beyond many retail industry insiders prediction since 1990s. New fresh produce distribution channel begin to gain pressure as demand on fresh items sales is higher than before. The increasing of consumer purchasing power and the awareness on health have brought the emerging of fruit specialty store numbers especially in big cities. Specialty food stores are different with traditional grocery stores due to the special products which are uncommon items offer by store and consumer possibly could not acquire in other stores (Wixson et al, 2011). Consumer might have different perspective on this new concept of grocery store and become a new marketing channel opportunity for fresh produce marketer to offer premium product.

Globalization has change shopping consumer behavior to have more practical shopping place and modern store become prominent choice for consumer. More consumer put interest to the existence of specialty food stores influence by external market environment development change such as economic, social and politic (Deller et al, 2009). Business sustainability and number of modern store growth that exist today can be achieve based on precise product choice provision (Kanjaya and Susilo, 2010). Specialty food stores could be generated to identify as successful marketing strategy and proposed understanding to retailers of whom represent their potential customer base searching to buy specific fresh produce (Wixson et al, 2011). This led to higher competition among modern grocery store and give more pressure for modern retail such as fresh fruit specialty stores to provide a better product quality offer for customer.

Food quality concept put as an important research topic and shows appreciation of a good overview in many distinct method to approach the concept. Although there is still a debatable issue to clarify food quality measurement that cover the concept (Acebron & Dopico, 2000; Bremner, 2000), the final of food quality that based on end consumer point of view show many proposed definition in the field and led to the development of user-oriented quality (Cardello, 1995; Brunsó et al, 2002).



In terms of fresh produce commodity, it is commonly prominent among consumers based on great flavors, nutrition content quality and product freshness (Lamikanra, 2002). Fresh produce quality used as consumer sensory properties consists of appearance, texture, aroma and taste (Abbott, 1999), while an obvious point of view of product quality suggest in more general term encompasses performance, features, reliability, conformance, durability, serviceability, aesthetic and perceived quality (Garvin, 1984). However, each fresh produce commodity has different characteristics, though it comes from distinct place or country of origin. Each fruit and vegetable are distinguished greatly from one to another in average of quality (Abbott, 1999). All mentioned fresh produce quality attributes, together with convenience additional attributes then become sales driver for each diverse fresh produce commodities (Lamikanra, 2002).

Apple as one of Indonesian consumer favorite fruit with shortage local production has caused the increasing of imported apple to fulfil consumer demand in Indonesia market. Most of imported apple sold at modern market such as grocery store and fruit specialty store with specific standard whereas provide premium product for business differentiation. Business competition facing by fresh produce businesses is the competition to provide better ability to give competitive price and product supply compare to local grown fresh produce price (Abdi et al, 2016). Moreover, different characteristics obtain by premium imported fresh such as apple fruit will need specific store marketing strategy to attract customer. Specialty food store that present the ability to identify their consumer target as their potential buyer can be utilized to construct an accurate success marketing strategy (Wixson et al, 2011). Meanwhile, fresh produce commodity has short display lifetime offer in store, then marketing strategy that employ product quality to optimize product shelf lifetime in urgently need.

This study try to give a new insight of how fresh fruit specialty store utilize product quality as their business success strategy and drive the customer to give concern on premium product that offers at store. The study include distribution structure elaboration to track product distribution and supply chain along marketing channel to describe how fruit quality treated along distribution. Product quality dimension interpret for customer on product display optimization as product physical prove directly sees by customer. In order to give clearer point of view, eight attributes proposed as general product quality attributes (Gravin,



1984) is adapt with specific fresh produce product quality characteristics of fresh fruit suggested by (Barrett et al, 2010) for a premium imported Sekai-Ichi apple fruit that supply for fresh fruit specialty store in Bandung City as vibrant metropolitan city in West Java Province of Indonesia with modern lifestyle running by its customer. A broader insight can be added to the limited studies on marketing product strategy of premium fresh fruit sold in specialty store in big city of a developing country.

LITERATURE REVIEW

Food Specialty Stores

The important driver of food market changes in developing country is drive by the development of modern retail (Minten & Reardon, 2008). However, the literature related to role of specialty store that sold food found to be limited available (Wixson et al, 2011). Though, several analysts stated that this type of store will vastly develop in order to benefit bigger opportunities while doing market segmentation, market target and product specialization (Sopiah & Syihabudhin, 2008). This based on specialty store is focus on specialty merchandisers and carefully choosing their market segment and providing product items with special requirements for targeted customer.

Specialty store can be classified as single-line store, which offer one specify product lines with numbers of product choice. Specialty store has product item with narrow product line and offer a lot of choices in the product line (Sopiah & Syihabudhin, 2008). Fruit specialty store that start to growth on early of year 2000 in Indonesia is able to provide unique products which are not available at supermarket. This type of store existence as modern fruit retail store is supported by qualified store employee who mastered fresh produce knowledge and used as company strength to increase customer convenience and satisfaction by giving better service and information related to fresh produce (Kanjaya & Susilo, 2010). Moreover, this type of store offer additional value based on convenient store location and enable customer to simply locate the place more comfortable.



Customer Driving Forces

Customer demand these days become more sensible than before, thus fulfilling customer requirements by ensuring their needs and wants with company capacity should be well adjusted (Hines, 2004). Rely business key success on market orientation become an essential question in the industry (Elg et al, 2012). Value driver that become key strategic at the store level is building the accurate combination of store format and other factors surrounding the retail environment (Grewal et al, 2010). Specialty store that focus on specific product for specific target market should adjust customer requirements and serve customer with the best product to sense customer change on demand. Driving forces for customer is relevant to sales force-driven to increase customer value toward product in business-to-business market (Balboni & Terho, 2016). Fresh produce that supply from foreign country through export-import trading activity involve various business actor across distribution chain, and each business actor and/or marketer is customer for the previous actor in the network chain.

Customer naturally do shop and purchase their needs in number of stores in many specialty stores. Thus, customer have the choice to buy the same product in different stores and it is customer privilege to be loyal to any store with no permanent means (Applebaum, 1951). Specialty grocery chain also driven by intends competition and fastidious customer that compete to offer product beyond quality and variety (Grewal et al, 2010). By offering different product to attract consumer curiosity is another opportunity to adapt consumer behavior changes and offer better product quality as retail business driving factor.

Fresh produce Product Quality

Quality is a modest with robust justification object and continue to identify by continues learning through events, thus it cannot be justified clearly (Parasuraman et al, 1985). Other define quality as attractiveness that simply realized subsequently any character of an object thrive to be exposed (Gravin, 1984) and perceived by customer as indicator of satisfaction relative of choices availability (Monroe & Krishnan, 1991). These indicate quality as total evaluation of product quality as prevalent references of product excellence



level and conformity that used as confirmation for standard preparation establishment (Monirul & Han, 2012).

It is important for each of distributor's and producer's to study what product items and how much of the items purchases by customer based on product brand, quality, weight, price, type of packaging and by season (Applebaum, 1951). This show that quality has become concern to all parties of product distributor and/or marketer in business network. The cues that could be used by consumers to conclude the expected and/or experience can define as product quality attributes and it is also called as product quality criteria (Grunert et al, 1996). Quality is the interpretation of all dimensions of the offered product that produce benefits for customer that include performance, durability, conformance to specifications, features, reliability, aesthetics, perceived quality and serviceability (Tjiptono, 2008).

Food quality defined as the compound characteristics that distinct single units of product with other, which determine significantly the acceptance degree for user of that particular unit (Kramer, 1965). The attributes of fresh produce quality such as fruit and vegetable may presented in four different attributes, there are color and appearance, flavor that include taste and aroma, texture, and nutritional value (Barrett, 2010).

RESEARCH METHOD

The study apply qualitative method with case study research design. Since the study propose to elaborate and determine the existing phenomena, the application of descriptive research design used to describe comprehensive insight of fresh fruit product quality dimensions provision in specialty store and its distribution mapping along with marketing product strategy of premium apple fruit. Data obtained through direct interview to key informants from specialty store managements who have role to the provision and marketing of premium fresh apple in the store with judgmental sampling technique along with observation that used as primary data of the study.

Mapping on product supply chain was employed to describe product movement and treatment along the way from the production origin place to end consumer. Product marketing strategy through product quality dimension analysis apply with Mean-end Analysis as a problem solving technique for product display optimization in store. The chosen fruit



specialty store has 21 outlets that spread in several main cities in Indonesia such as Jakarta, Bogor, Tangerang, Bekasi, Bandung and Surabaya. Store outlet that located in Bandung is one of the oldest branch of the company and well-known across consumer in Bandung City area. This type of fruit specialty store in Bandung City also found to be limited number, which mean facing less competition among the business. Thus the store outlet choose as representative case study to describe premium fresh fruit commodity is selling in big city such as Bandung.

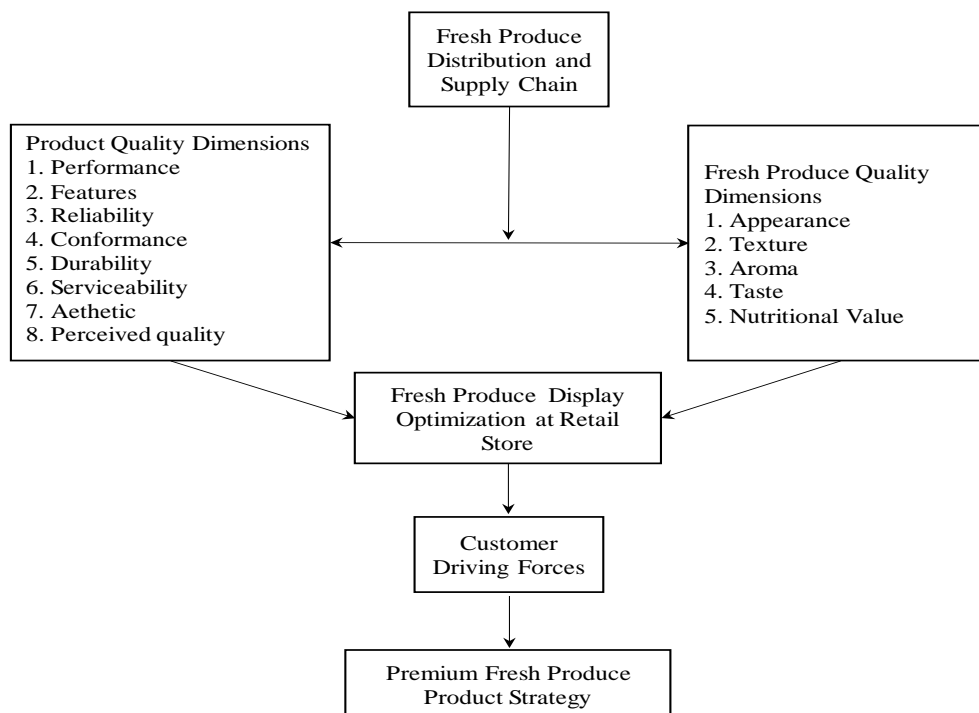

Figure 1. Research Framework

RESULT AND ANALYSIS

Sekai-Ichi Apple Fruit Distribution and Supply Chain

Distribution and mapping the product supply chain is strategic key to understand business actor activity and what is share among them also the product movement and characteristics. Supply chain map will help to assist opportunities identification each element of material, financial and information flow from one to another. In this map, it can be seen that the imported Sekai-Ichi apple product flow started from Qingdao Shijie Industria as



producer in China that offer their product within six months before harvest time. Buyer should approve the agreement via legal contact to proceed the product preparation to be exported abroad. The apple fruit is package in big Styrofoam box that consist of nine pieces of fresh Sekai-Ichi apple. Each box weighted for five kilograms of fresh apple, and the product sent in not yet ripe condition to manage and measure distribution time and length that require extensive term and condition from China to Indonesia. Distribute fresh cut commodity to numerous distribution area contain risks and retailers as the final marketing channel need to reduce the uncertainly environment and risks as business driver (Hogarth-Scoot, 1999).

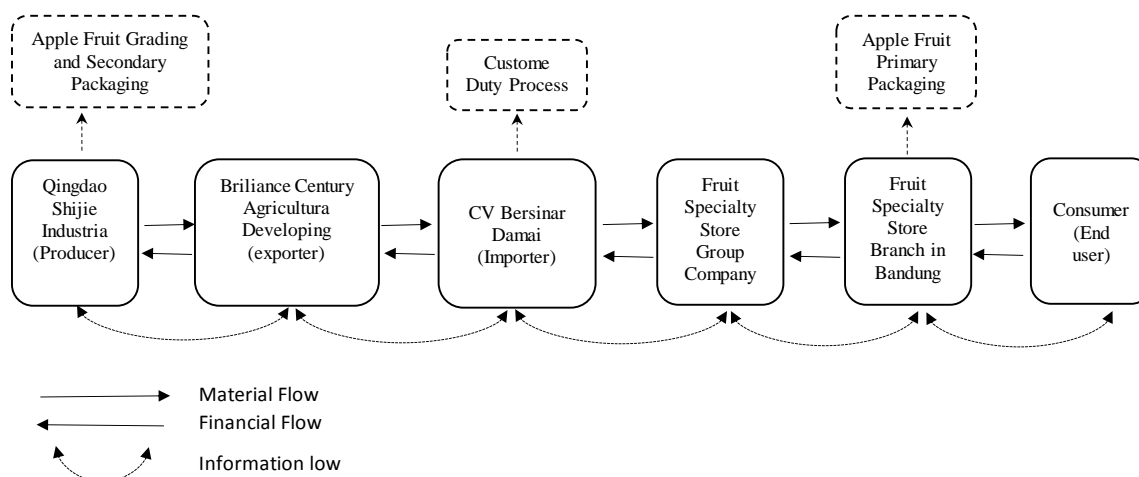

Figure 2. Sekai-Ichi Apple Product Distribution and Supply Chain

Sekai-Ichi apple producer distributed the product through Export Company and use trading harbor such as Tanjung Priok in Jakarta or Tanjung Perak in Surabaya as the first point of product distribution in Indonesia. Distribution track will depends on government regulation. Imported fresh product will pass the duty process and distributed to import company. Custom duty process will impact on time delay for product to be sent to local distributor company and once influence fresh apple condition and quality. Food specialty store as retailer rely business driver relating to risks and environment uncertainly is employ to improve the integrity of supply chain, to serve greater consistency, to improve quality of fresh cut commodity and to lower cost by achieving economics of scale (Hingley et al, 2005). Local Distributor Company sold the product to local buyer such as fruit specialty Store

Company and then distributed to each store branch in several area. Store branch receive fluctuate product quantity each time, ranging from three to five boxes. In order to maintain product freshness, primary packaging with individual packing made from small Styrofoam plate size and coated by transparent plastic. This product attribute strategy use to exposure product uniqueness of Sekai-Ichi apple that weighted unusual with bigger size compare to other fresh apple offer in the store. This made the product special and unique called as premium commodity.

Financial flow proceed different flow with material, which started from end consumer to producer. It involve payment from each actor of the business network and legal prove showed by end consumer receipt, buyer invoice along with term of payment. Meanwhile, information flow goes for both side of each business actor vice-versa. Information sharing consists of product capacity, delivery status and order information. Foreign marketing that involve export and import companies usually adapt more structured selling system with proper legal contract. This will ensure product quantity, quality and continuity in the market. Fair information sharing among marketer and supplier along the network chain is essential in today's business. Supplier supportive action along the supply chain is part of supportive action on market driving strategy ((Elg et al, 2012).

Sekai-Ichi Apple Product Quality Dimensions

Fresh fruit quality attributes show different characteristic compare to process or manufacturing product. The result show that basic product quality dimensions of imported fresh apple has generally fitted the quality standard that adjusted for premium fresh produce commodity. Special treatment interpreted through individual packaging and investing on cold storage facility directly impact on product quality related to freshness, texture and appearance. Freshness related to keeping the apple in a proper temperature, while texture related to the nature of fruit skin surface and appearance subjected to fruit maturity and ripeness. Fruit maturity is the most essential and significant factor to determine fresh produce storage life and final decision of fruit quality based on accurate harvest time (Lamikanra, 2002; Qi et al, 1999). However, the nature of Sekai-ichi apple has no specific aroma is identify reliability dimension become less reliable and can be replace with providing higher



product grade showed by its size and, color and texture. Meeting market requirements is urgently need to be succeed, by fulfilling product quality standards, providing cooling storage facilities, delivering a well-packed product and supplying minimum volume quantity (Burt et al, 2008). Meanwhile, feature dimensions represent fresh apple quality by applying individual packaging as product attractiveness and exclusive to present higher value through higher product benefit although with higher price to enjoy the premium fruit. It is common that most buyer prefer to receive fresh produce such as fruit with a particular type of packaging, due to its image to present superior-quality product (Burt et al, 2008). A better treatment on fresh fruit display in cold storage and the use of packaging will benefited to longer storage life of the product and leave less unsold items to be dissolved as product loss.

Table 1. Sekai-Ichi Apple Product Quality Dimensions

Product Quality Dimensions	Indicator(s)	Fresh Produce Quality Dimensions	Quality Dimensions Achievement
Performance	Basic operation characteristic of a product	nutritional value	Source of vitamin A and C with additional nutrition that able to prevent heart disease, cancer, help digestion system, body cleaner from chemicals and metal, and absorb fat
Durability	Product time length and endure before being replace or dissolve	freshness	3 to 7 days in cool storage store display after one month journey from its origin production
Conformance	Confirm to specific requirement characteristics	texture	Clean, smooth fruit skin surface without defect
Features	Product additional design for	packaging	Individual packaging using Styrofoam and transparent



	completeness		plastic to prevent physical contact with store employee and customer
Reliability	Probability of product satisfy for consumer	aroma, taste, grade	No specific aroma, sweet taste and sorting for grade picking
Aesthetic	Product appearance	appearance	Similar color with red domination and size of 400 to 600 grams per piece
Perceived quality	Indirect consumer measurement on product use	labeling	Less information of product knowledge on product label
Service ability	Additional service to serve customer	cold chain facility, waste product (unsold product) system	Cool storage provision with specific temperature, but less special individual treatment that leave unsold product dissolve as waste

Sekai-Ichi Apple Product Strategy at Fruit Specialty Store

The proposed product strategy for premium fresh apple fruit in Fig. 3 showed the most critical factors that identified as the problems need to be solved to optimize product display. As shown on the framework, Fruit specialty store goals are to provide the best fresh produce quality to fulfil customer needs and wants. Company weakness providing imported fresh apple is the product quantity fluctuation that effect supply continuity, which influence consumer satisfaction and loyalty toward shopping at fruit specialty store. The emerging of supermarket, grocery store, and other modern retail to provide consumer demand on fresh produce need to be addressed to maintain business profit and sustainability in the business.

Current situation of providing imported fresh fruit at specialty store that rely the business only on specific product line is threated by nature characteristics of fresh produce that has short storage lifetime and possibly produce low product quality in shelf display. Fresh apple that keep longer in the shelf will less attract customer as product physical



appearance has change to be wrinkled and poor. Thus, proposed product strategy for premium fresh apple based on product quality dimensions as market driven is creating product rolling system in storage shelf along with everyday product sorting. Company should give product knowledge training for store employees to improve employee knowledge toward producing high fresh apple quality especially regarding to higher product durability, increase product conformance and increase customer perceived quality. Customized fresh apple provision with current store management system can lowering cost and customize apple product provision and periodic order adjustment to lower transaction cost arising in supplier and cost hidden in customer's sphere. A lower cost perceived by customer assume to increase customer perceived value. A market driven approach can be succeed if there is an adaptations on modification functionally which away from supplier business model intervention (Elg et al, 2012).

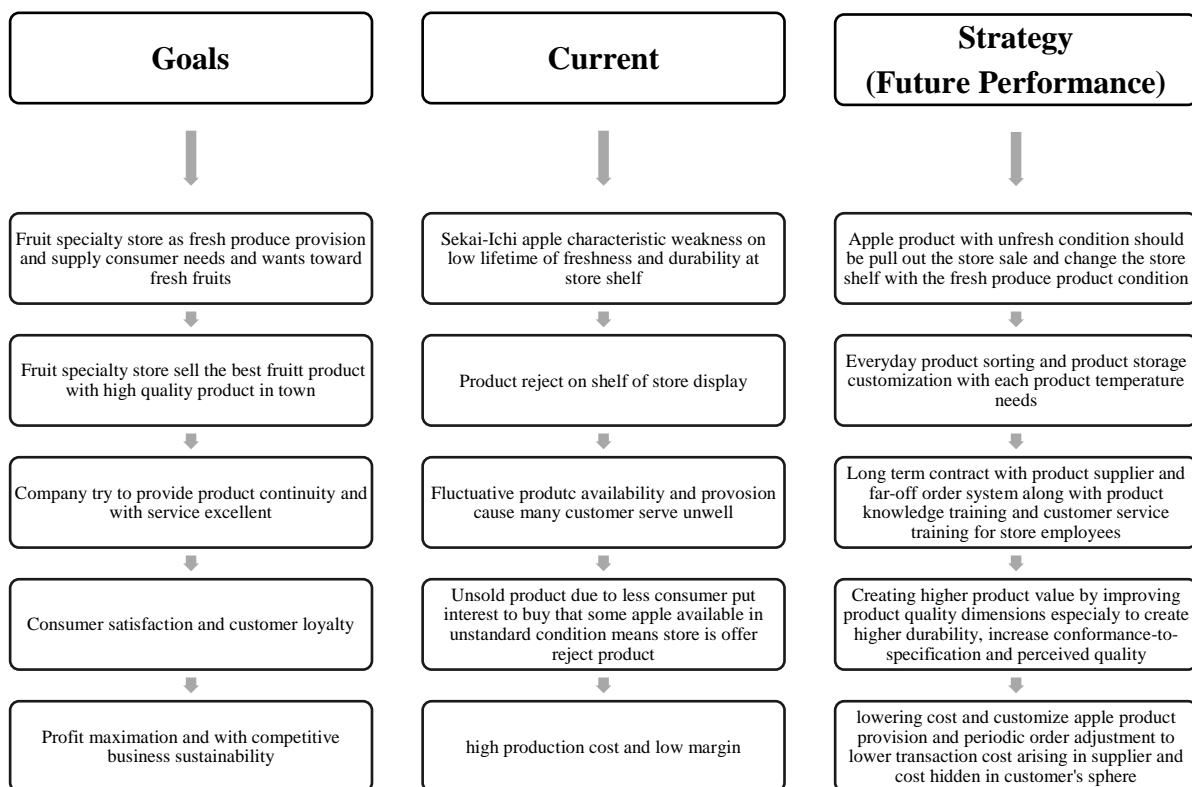

Figure 3. Mean-End Analysis of Product Marketing Strategy for Premium Fresh Apple Provision in Specialty Store



DISCUSSION AND CONCLUSION

The study found that product supply on premium fresh apple that imported from China to Indonesia and sold at fruit specialty store based on distribution and supply chain description can be seen as structured market format with horizontal supply chain type of short food supply chains (SFSCs). This is an alternative strategy to concentrate product distribution and supply based on inter-relations among supply chain actors start from producer on up-stream system to specialty store retail on down-stream system in order to gain lower cost and efficiency.

The conclusion suggested from Mean-end analysis result as problem solving toward premium fresh apple product quality dimensions proposed improvement on future performance through product value co-creation on product quality benefit on higher durability, increase conformance-to-specification and customer perceived quality and adjust cost with lowering cost arising in supplier and customer. This problem solving adjust between company objectives and company current condition related to premium fresh apple product quality that sold at specialty store as customer value driven and meeting customer behavioural changes on fresh fruit. Premium fresh produce should present superior-quality product to gain consumer attractiveness and compete with other fresh produce with various quality standard.

REFERENCES

- Abbott, J. A. (1999), "Quality Measurement of Fruits and Vegetables", *Postharvest Biology and Technology*, 15, pp.207-225.
- Abdi A., Rangkuti F. Y. and Wright, T. (2016), *Indonesia Retail Foods Update*, GAIN Report ID1638, USDA Foreign Agricultural Service.
- Barrett, D. M., Beaulieu, J. C. and Shewfelt, R. (2010), "Color, Flavor, Texture, and Nutritional Quality of Fresh Cut Fruits and Vegetables: Desirable Level, Instrumental and Sensory Measurement, and the Effects of Processing", *Critical Reviews in Food Science and Nutrition*, 50, pp.369-389.
- Burt, L., Moulton, C., County, S., and Kropf, J. (2008), *Marketing Alternatives for Fresh Produce*, Pacific Northwest Extension Publication PNW 241-E.



- Acebron, L. B. & Depico, D. C. (2000), "The Importance of Intrinsic and Extrinsic Cues to Expected and Experience Quality: An Empirical Application for Beed", *Food Quality and Preference*, 11, pp.229-238.
- Applebaum, William. (1951), "Studying Customer Behavior in Retail Stores", *Journal of Marketing*, 16, 2, pp.172-178.
- Balboni, B. and Terho, H. (2016), "Outward-looking and Future-Oriented Customer Value Potential Management: The Sales Force Value Appropriation Role", *Industrial Marketing Management*, 53, pp.181-193.
- Bremner, H. A. (2000), "Toward Practical Definition of Quality for Food Science", *Critical reviews in Design Issues Marketing and Research Today*, 40, pp.83-90.
- Brunsó, K., Fjord, T. A., Grunert, K. G. (2002). *Consumers' Food Choice and Quality Perception*, Working Paper No.77 ISSN 0907 2101: The Aarhus School of Business.
- Cardello, A. V. (1995), "Food Quality: Relativity, Context and Consumer Expectation", *Food Quality & Preference*, 6, pp.163-170.
- Elg, U., Deligonul, S. Z., Ghauri, P. N., Danis, W., and Tarnovskaya, V. (2011), "Market-driving Strategy Implementation through Global Supplier Relationship", *Industrial Marketing Management*, 41, pp.919-928.
- Garvin, D. A. (1984), "What Does Product Quality Really Mean?", *Sloan Management Review*, 25-43.
- Grewal, D., Krishnan, R., Levy, M. and Munger, J. (2010), "Retail Success and Key Drivers", *Retailing in the 21st Century Current and Future Trends*, XV, pp.1-30.
- Grunert, K. G., A. Baadsgaard, H. H. Larsen, and T. K. Madsen. (1996), *Market Orientation in Food and Agriculture*, Kluwer Academic Publishers: Boston.
- Hines, Tony. (2004), *Supply Chain Strategies: Customer-Driven and Customer-Focused*, Elsevier Butterworth-Heinemann: Oxford.
- Hingley, M. K., Lindgreen, A., and Caswell, B. (2005), "Supplier-retailer relationships in United Kingdom fresh produce supply chain", *Journal of International Food & Agribusiness Marketing*, 18,1/2, pp. 49-86.
- Hogarth-Scott, S. (1999), "Retailer-Supplier Partnerships: Hostages To Fortune Or The Way Forward For The Millennium", *British Food Journal*, 101, 9, pp. 668-682.



- Kanjaya, Meshvara and Susilo, Yongky. (2010), *Retail Rules*, Erlangga: Jakarta.
- Lamikanra, Olusola. (2002), *Fresh-Cut Fruits and Vegetables: Science, Technology and Market*, CRC Press, Florida.
- Minten, B. and Reardon, T. (2008). “Food Prices, Quality and Quality’s Pricing in Supermarkets Versus Traditional Markets in Developing Countries”. *Review of Agricultural Economics*, 30, 3, pp.480-490
- Monirul, I, M., and Han, J. H. (2012), “Perceived Quality and Attitude toward Tea & Coffee by Consumers”, *International Journal of Business Research and Management*, 3, pp. 100-112.
- Monroe, K. B., and Krishnan, R. (1985), “The Effect of Price on Subjective Product Evaluation” in *Perceived Quality*, J. Jacoby and J. Olson, eds., Lexington, M. A: Lexington Book, pp. 54-65.
- Parasuraman A., Zeithaml V. A., and Berry, L. L. (1985). “A Conceptual Model of Services Quality and Its Implications for Future Research”, *Journal of Marketing*, 49, pp. 41-50.
- Qi, L., Wu, T., and Watada, A. E. (1999), “Quality Changes of Fresh-cut Honeydew Melons During Controlled Atmosphere Storage”, *Journal Food Quality*, 22, pp.513-521.
- Sopiah and Syihabudhin. (2008), *Bisnis Ritel*, Andi: Yogyakarta.
- Tjiptono, Fandy. (2008), *Strategi Bisnis Pemasaran*, Andi: Yogyakarta.
- Wixson, S. E., Katchova, A. L., Woods, T. A., Hu W. (2011), “The Role of Specialty Food Stores And Farmers’ Markets in The Procurement of Local Foods”, *Proceeding on Southern Agricultural Economics Association Annual Meeting, Corpus Christi, TX, February 5-8*.



SHARIA MARKETING ANALYSIS IN NOOR HOTEL BANDUNG

Arianis Chan

Ratih Purbasari

Pratami Wulan Tresna

Business Administration Padjadjaran University

arianis.chan@unpad.ac.id

klik_ratih@yahoo.co.id

pratami@unpad.ac.id

Abstract

Currently sharia industry is showing growth fast enough due to Islam as guidelines of life has implemented on many sectors. This study aims to analyze the sharia marketing implementation of Noor Hotel. Noor Hotel was chosen because the hotel was the largest hotel with sharia concept in Bandung and obtained the positive responses from the guests.

The research was using qualitative method and explorative research approach. The data gathered from the observation, in-depth Interviews to leadership, marketing manager, employee and Noor's Hotel consumers, and marketing literature study.

The result shows that Noor Hotel has executed the elements of sharia marketing mix. The entire elements was used as tools such as product, price, place, promotion, process, people, physical evidence, promise and patience, has done well to realize the value of Islamic values.

The suggestion is that Noor Hotel can be more promotions in several medias and adds kind of services which develop the potential of sharia hotel in the future. It also holds the sharia principles, so that can be reach the wider markets.

Keywords: Sharia Marketing, Sharia Hotel, Noor Hotel

JEL Classification: M41



INTRODUCTION

The moslem market share is a very large market, especially in the ASEAN market with the largest moslem population today. Therefore, some companies have taken advantage of this concept in their business itself. Not only applied to Islamic banking, Islamic business has also spread in various types of businesses, from start Takaful, sharia pawn shops, salon sharia until sharia hotel. Problematic in using sharia label in the hotel business continues to be a source of confusion for owners, managers and hotel management as well as consumer sharia. There are still many doubts in the industry about what is called the 'sharia', especially the term ' sharia hotel '.

Hermawan Kartajaya and Syakir Sula give the sense that Islamic finance is a business-mannered, business togetherness and respect for the rights of each (Antonio, 2010). While sharia hotel is an accommodation service that operates and adheres to the guiding principles of Islamic teachings. In operation, services provided in sharia would almost resemble a conventional hotel / non-Sharia in general. But, the concept of this hotel balances the spiritual aspects of Islam that prevails in the management and operation. However, until now packaging sharia hotel still impressed as less classy accommodation and lack of supporting facilities. Until now, the hotel where sharia dominated by jasmine-class hotel and hotel to the level of no more than three stars level only. (Anwar Basalamah, 2011).

In order to broaden public awareness of the existence of sharia hotel, a marketing concept becomes absolutely necessary, particularly related to marketing ethics based on Islamic perspective. The implementation of marketing ethics in Islam uses two sources are the Qur'an and the Sunnah of Rasulullah saw. Quran explains theoretical ethics, whereas the Sunnah explains the ethics of the application in real life or in practical terms. This is certainly very different from the company which is based on the conventional system.

One of the hotels at the same time apply sharia business marketing from the perspective of Islamic ethics is Noor Hotel Bandung. Hotel Noor can be regarded as a pioneer of boutique sharia in the city of Bandung. Based on the results of preliminary interviews with some of the service user researchers hotel and the hotel management, information obtained as follows:

1. Consumers liked the theme of the hotel is Islamic (Turkey) and interior design,



good rooms and hotel surroundings are unique and attractive impression.

2. The process is very nuanced service provided Islam with a greeting and started by giving zam-zam water.
3. The promise of the low price can be accepted by consumers because the hotel Noor provides transparent prices.
4. Hotel Noor applies Islamic principles in their daily operations, such as halal food without alcohol one bit on each cuisine.
5. Hotel Noor only allows guests who stay are fellow unrelated to avoid defamation by ensuring consumers KTP

Thus it can be assumed that the hotel Noor has implemented marketing ethics that includes the marketing mix such as price, product, promotion, place, and people in accordance with the Islamic perspective, so it needs to be studied more deeply about the strategy applied by the company in support of the successful implementation of the marketing ethics.

Based on the phenomenon and the information described above regarding the application of marketing ethics based on the Islamic perspective on the hospitality industry, the writer interested to take the title of the study: "Analysis of Marketing Ethics based on Islamic Perspective at Noor Hotel Bandung".

LITERATURE REVIEW

Marketing Reviewed from the perspective of Sharia

Islamic marketing is a discipline that directs strategic business process creation, supply, and changes in values (value) than one initiator (initiator) to its stakeholders, which is in the overall process in accordance with the contract as well as the principles and muamalah in Islam. (Bukhari Alma and Donni June Priansa).

According to Ahmad Munzirin (2009), that the marketing strategy according to Islamic principles of sharia perspective, marketing activities must be based on the spirit of worship of God the Creator, as hard as possible for the common welfare, not for the sake of its own interests let alone group.



Hermawan and Sula (2006) also defines sharia marketing is a strategic business discipline that directs the process of creation, bidding, and change the value of a initiator to its stakeholders, which in the process in accordance with the contract and the muamalah principles (business) in Islam.

According to Sula and Hermawan (2008:28-42), there are 4 characteristics for a marketer to become a marketer in accordance with Sharia provisions, namely:

1. Teistis (Rabbaniyyah)

A marketer believes that any of his actions are always observed and recorded by God Almighty. So as much as possible marketers shy away from any kind of deplorable and which marketing activities are forbidden in Islam.

2. Ethical (Akhlaqiyyah)

Moral values is very taken care of in the marketing activities of Sharia because nature is closely related with the teistis or rabbaniyah because his behavior will be accounted for later in the hereafter, then a marketer trying to keep himself from dirty practices. Therefore, the creed, morality, and sharia is closely associated with the daily life of a marketer.

3. Realistic (Al-Waqi'iyah)

Islamic sharia is flexible and not rigid, and this makes a marketer free to do its marketing strategies but not out of Islamic rule.

4. Humanistic (Insaniyyah)

This view gives the sense that human life needs to be controlled, balanced, and does not act arbitrarily by obeying his Eve. Don't discriminate between people based on their identity. The treatment of all persons the same although different tribes, customs, and language.

According Abuznaid (2012: 1477) who defines marketing based Koran (4:29), the Hadith, Islamic literature, and a statement of some scholars of Islam, sharia marketing is a policy to meet the needs of consumers through good behavior in delivering products and services that are kosher, helpful, pure, good and lawful with the consent of sellers and buyers are aiming to achieve material and spiritual happiness in this world and hereafter and make consumers aware through good behavior of marketers and advertising ethics.



The Marketing Mix Reviewed From The Sharia Perspective

Islam teaches that in marketing activities, there are two principles proposed by Niazi in Abuznaid (2012: 1481) is the first, submission to the commands of Allah. and second, a sense of empathy and compassion for his creatures that indirectly refrain from doing evil to others, as well as to refrain from acts that are not ethical.

Abuznaid (2012) suggests the marketing mix (marketing mix) 9P viewed from the perspective of sharia, are: product, price, promotion, place, people, process, physical evidence, coupled with the promise and patience as a part of the element which is seen as an Islamic mix. The marketing mix outlined in the discussion below.

Product

The Shariah rules teach the concept of halal, haram, and syubhat. Halal is something that is possible and legitimate according to Islamic law, while haram is something that is not allowed or it can be said that haraam is the opposite of halal. Shuhaimi (2012:122) revealing an explanation firmly about something forbidden i.e. carcasses, pork, and alcoholic beverages. Shuhaimi added that Quran ever banned gambling and prostitution, in addition animal blood was not allowed to be consumed.

While syubhat is something doubtful whether lawful or unlawful and should be shunned. Even Al-Ukhuwa in Saeed, et. al. (2001: 131) adds that, the product must not be defiled. He has categorized the items 'unclean' into four types, the essence of which is unclean like dogs and pigs, something that made unclean by the merger (contamination), which is made unclean by contamination but its usefulness is not completely destroyed, for example, clothing unclean, something unclean by contamination that destroys all their usefulness, such as oil-contaminated. In other words, the production process must be kosher and pure (thayyib) and must be able to guarantee the material has been taken / extracted / obtained from a legitimate source, the free levels of harmful effect. Al-Faruqi in Saeed, et. al. (2001: 131) says that the principles of Islam ordered that production operations must be free of sin and holiness from beginning to end.



Price

Pricing in a sharia perspective, it's not too complicated, the basic pricing is concentrated on the magnitude of the value or price of a product that should not be defined by many times the amount, after deducting production costs (read: *riba*). (Ita Nurcholifah, 2014)

Abuznaid (2012) states that the price is the most flexible element in the marketing mix. Creepage and Hamdani (2011: 72) also state that the pricing strategy (pricing) is very significant in providing value to consumers and affect the image of the product, as well as the consumer's decision to buy. Pricing is also related to income and also influenced the bidding or marketing channel.

There are some Islamic principles that limit the pricing so that marketing activities do not cause any harm to consumers and marketers. One of them, according Abuznaid (2012) to avoid predatory pricing in order to win the competition. Hoarding to make huge profits is not allowed.

Promotion

Al-Ukhuwa in Saeed, et. al. (2001: 133) states, in marketing ethics of Islam, it is not ethical people overestimate product excellence and quality attributes to consumers that do not exist in the product. Saeed Ahmad in, et. al. (2001: 133) adds, if both parties to tell the truth and explain the defects and quality (which is on the product), then they will be blessed in their transaction, and if they are lying or hiding something, then the blessings of transactions they will disappear.

Place

Abuznaid (2012: 1487) states, in the provisions of sharia, distribution channel does not create a burden to the end consumer. In the ethical framework of Islam, however, the main purpose of distribution channels is to create value and improvement of living standards by providing satisfying services are ethical. In the perspective of Sharia, marketing channels or company location can be anywhere as long as it is not a place where the disputed existence. However implied, Islam is more emphasis on companies with market proximity. This is to avoid the interception action stuff before it gets to market. (Ita Nurcholifah. 2014).



People

Saeed, et. al. (2001: 139) states that the seller must provide all the information you need to know about a product or service to enable customers to make informed decisions. In fact, access to such information is a customer right under Islamic law. Every transaction is concluded under the constraint or coercion is forbidden because of the ability to think rationally when making any decisions is a prerequisite legitimate under Islamic law.

Abuznaid (2012: 1490) mentions several sharia regulations related to employee uniforms, especially for women employees should be dressed decently and tidy, wearing the veil and do not use make-up is excessive, and do not wear tight clothes that show the curves, that is adapted to a traditional Muslim dress.

Process

Abuznaid (2012:1491) declaring the elements of the process include the procedures, mechanisms, and Groove activity correspond to the services offered. Process also means how the product will be up to the end user, it is also very crucial towards customer satisfaction. Problems such as waiting time, the information given to consumers, the alertness of employees, efficiency in the provision of services, the interaction of employees with the right style, it all is vital to keep customers happy. Consumers are not interested in the details of how the business is run, they want to know is the job system is still running.

Physical Evidence

Physical evidence can be in the form of tangible goods that help to communicate and provide services, and intangible experiences to consumers and businesses the ability to deliver customer satisfaction to potential customers (Abuznaid, 2012). Quality of service can not be felt before the services are distributed to consumers, in addition to the quality of services is difficult to evaluate objectively by consumers so that they often judge of tangible evidence around services. Physical evidence by Abuznaid (2012) includes the Facility Exterior, interior amenities and assets other tangible assets.

Each room also needs to be equipped with a manual towards the Qibla and put a Koran and prayer tool in every room. RJ (2011) also states sharia hotel also need to be



equipped with a separate mosque between men and women is by using the limiting prayer area. In addition, should not be held smoking area and ashtray, although the law has not forbidden, but cigarette smoking is considered more good's *madharat*.

Promise

Abuznaid (2012: 1494) states the promise of management that shifts the marketing mix to build relationships with customers. A company can attract new customers with various promises and as an initial effort to build customer relationships.

Fulfill promises made to be vital to ensuring customer satisfaction, customer retention of the company, and profit in the long term. Abuznaid (2012) adds a marketer need to underline that the pledges are met and maintained for marketers shall not give false promises to its customers.

Patience

Patience is another element in the marketing mix of sharia. Abuznaid (2012: 1495) states the importance of patience element in the service industry. Islam encourages marketers to possess patience in conducting marketing activities with customers, because patience is a key characteristic in good communication efforts



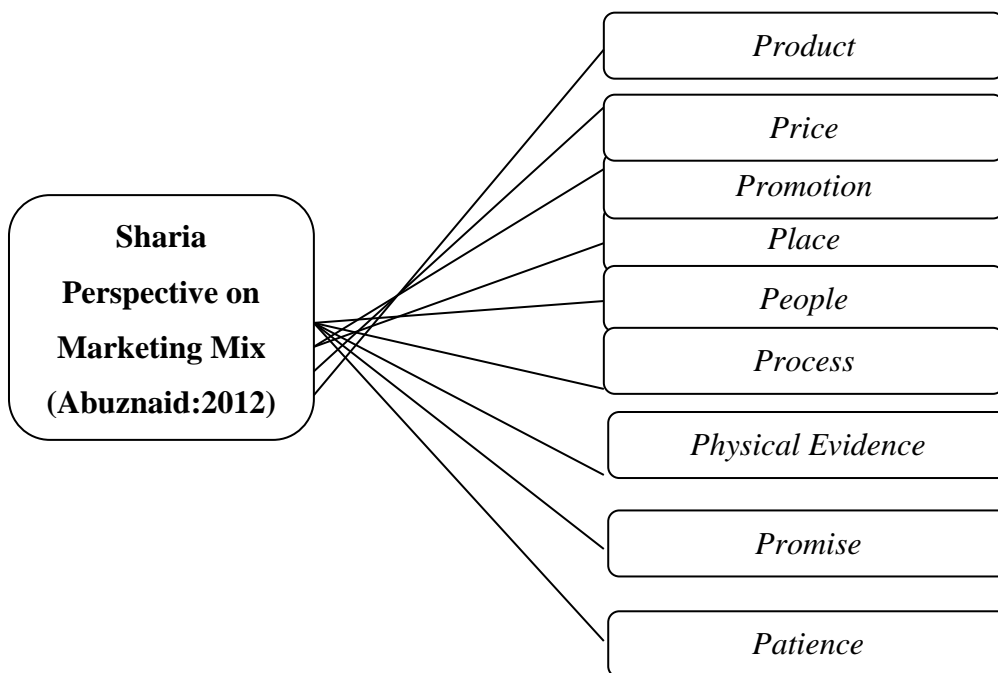

Figure 1. Conceptual Framework

RESEARCH METHODS

This research used a qualitative research method. Sugiyono (2009: 3) found in qualitative research, data collection was not guided by theory, but is guided by the facts found during research in the field. The object of research is taken from the marketing mix in terms of Sharia perspective on Noor Hotel Bandung consisting of product, price, promotion, place, people, process, physical evidence, promise, and patience. This type of research used by the writer is descriptive research.

Sources of data used of primary data and secondary data sources. Sources of primary data obtained from interviews with the Marketing Manager of Hotel Noor and several consumers who've been to Hotel Noor. Secondary data sources include documents from Hotel Noor, Website and Internet-related data from the Hotel Noor, advertising in social media, photos and video.

Validity or credibility of data examined through the completeness of the data obtained from various sources. The author uses triangulation techniques to test the validity of the data

obtained. Sugiyono (2009: 125) argues that in testing the credibility of this triangulation is defined as checking data from various sources in various ways and at various times.

Data Analysis Techniques

In this study, the data analysis done since before entering the field against some of the results of preliminary studies or secondary data in order to determine the focus of research. However, the focus of research can develop when the author conducts research activities in the field. Data analysis was performed when data collection takes place. At the interview, the authors conducted an analysis of the answers to the informant, if deemed unsatisfactory, the author went on to question the data is considered satisfactory.

The process begins with a data analysis that summarizes the data reduction, choose things that are the principal focus on the things that are important so it is easy to be interpreted. Then examined the validity of data by comparing data from other sources with a variety of data collection techniques. Furthermore, the conclusion stated and supported with some evidence of a valid order stated conclusion can be said to be credible.

RESULTS AND DISCUSSION

Product

Noor Hotel comes from the light. Noor has a tagline: Friendly Boutique Moslem. Noor Hotel owned by PT. Sekawan which is a family company. Noor Hotel provides a variety of services to meet the needs of his guests in the form of tangible products (tangible) and intangible (intangible). Products that fall into the category of tangible at the hotel is the food and beverage, whereas intangible product that is, services meeting package, social event packages, table manner packages, honeymoon packages, engagement and marriage ceremony package, wedding package, pre wedding package, muhasabah package and rituals of the package as well as room service and laundry.

Based on observations made by the author, Noor Hotel has 33 rooms consisting of Executive and Deluxe rooms. Each room is equipped with air conditioning, satellite TV, bathroom with hot water and cold water, as well as wi-fi facilities. In every room are



provided the Qur'an, Sejadah, mukena and beads are packed pretty. There is also the facility of free bicycles that can be used to travel around Bandung

The products offered by a company if it refers to the laws of sharia in foods and beverages is lawful and good or thoyyib, besides avoiding anything unlawful, also should avoid anything questionable or syubhat. A marketer needs to ensure that the products offered to consumers are lawful, both on the type of food or drink itself or in the manufacturing process are not mixed with anything unlawful. Application of Noor Islamic system in the hotel is also available on the use of kosher foods.

Price

The price is determined by the company will describe the image of the products it sells, the price applied by Hotel Noor is about 860,000 up to 1,650,000 and will be cheaper to publish rate. The price is inclusive of dining facilities in the morning (breakfast) for two people. Prices are applied according to interviews with several customers is in accordance with the services provided by the hotel.

If seeing elements of the implementation of Islamic system in the price of the Hotel Noor had to apply where there is no cheating in the price, the price has been published with an honest and fair means consumers get services that are comparable, not to apply predatory pricing that is applying a very low price which is the main objective to get rid of competitors and prevent competitors into the same business.

Prices usually change when faced with a certain time period such as the high season is during the long holiday, major holidays in Islam such as Idul Fitri and Idul Adha, or the New Year. The increase in price is usually around 20-30% of the normal price. When commodity price changes are usually rare and setting price ceilings to control opportunistic tendency among traders are also allowed in Islam mechanisms of price adjustments and fair competition is strongly encouraged. (Samir Abuznaid, 2012: 1485).

Place

Hotel Noor is located at Jalan Madura No. 6, Bandung. The village is located in the city center and is easily accessible by public transport or private vehicle other than that there



are several other hotels in the vicinity. One featured by Hotel Noor apart hotel with Islamic nuance is the proximity to a variety Factory Outlet is located in Jalan Riau which is very close to the hotel as well as Riau Junction Mall and Bandung Indah Plaza but it is also the location very close to some restaurant.

Through interviews conducted, the manager stated that Noor Hotel does not have branches everywhere so the hotel using the specific ways to reach the hotel guests who live in other cities and even abroad. How that is done is to use a travel agent website.

Travel website used by Noor Hotel apart as media campaigns, website travel agent is used also assist in the delivery of services to consumers. Website of the travel agency that booking.com, traveloka, expedia.com, klikhotel.com, hotelbandung.com, pegipegi.com, tripadvisor.com. Hotel guests can book a room rental service through the existing website. Besides being convenient, this channel is also gated and reliable to help consumers get hotel services as you wish. Prospective customers can also order directly when arriving at the site of Noor Hotel through the receptionist on duty at the front desk.

According Abuznaid (2012) that the distribution channel in the rules of sharia is not to create a burden on the final consumer but rather to provide facilities so that the delivery of a product can be made more effective and efficient. Because of the security in the process of distribution of hotel services in a matter of concern. This safety factor is also the need to be considered by companies in which the privacy of each guest also needs to be maintained. Consumers should not feel disadvantaged both morally and materially, because the most important thing in Sharia is prosperity for both sides, both for consumers and for marketers, not to increase the burden for both.

Promotion

Hotel Noor has been promoting the principle of sharia. The message refers to the provisions of sharia are not exaggerating product. Promotion only focuses on physical details contained in the product, even if it needs to be supplied with a deficiency or defect of the product so that the consumer will not feel cheated later. This is shown by the Hotel Noor on company profile is displayed on its official website. In addition the company also uses



several social media such as instagram, twitter and facebook. The print media used Laiq magazine, electronic media used is Faithful in Trans, Inspira Cable TV, TV MQ.

In Sharia, which justified the promotion is promoted by not exploiting women, this is to avoid the possibility of inviting lust. In addition to the rules of Islamic law should not be promoted with exaggerated compliments on the service or services to be provided, giving rise to a public lie. Besides all claim which contains an element of coercion, it must accurately disclose the specifications in terms of quality and quantity of the products to be offered, the obligation to disclose a fault or defect that is if he is hidden or visible. Islam condemns all promotional manipulative behavior (Samir Abuznaid, 2012: 1488). Hotel Noor also has implemented sharia system in its promoting, for example in suggesting deficiencies that exist in the hotel always preached to consumers as sound systems problematic when rent rooms for meetings. In the hotel's website is not to show women as a means of exploitation.

People

People in the marketing mix is primarily employees. Employees are an integral part of the service process and play an important role in the marketing process. Employees have to be patient, fair, honest and accountable. (Abuznaid, 2012: 1489).

Based on interviews with hotel managers, employees working at Hotel Noor is an experienced personnel that previously had worked at the hotel that has been reliably serving guests maximum. Terms requirements to become an employee at Noor hotel are: Muslim woman dressed in full hijab / niqab, men dressed koko, shar'I appearances, and odorless body. In serving customers Hotel Noor applies the principles of 5 S: Hail, Smile, Greeting, Courteous and Polite. At Noor hotel also has an obligation to implement the Friday prayer for male employees and prayers mandatory for all employees. It also continued to implement the values of Islam to every customer by any employee at any time. Hotel Noor also always provides training on new employees to get to know the products.

Employees are also given the freedom when it came time to pray to pray especially for the Friday prayers. Male employees are obliged to leave work for a moment to go to the mosque not far from the location of Noor. Female employee was able to carry out their daily prayer in the mosque. A company is not allowed to restrict sharia employees who want to



worship, especially when the prayer time has arrived. In fact, companies need to encourage them to always obey to Allah SWT, because of that's the most important key in creating skilled human resources and noble.

Process

Process became one of the factors to deliver services to the hotel guests, making guests satisfied and create good customer relations. Procedure and flow of activity is part of the process in the form of certain stages until those services to the hotel guests.

Chronology of activities that occur on Hotel Noor when guests arrive at the front desk that greeted guests with the principles of 5 S: Hail, Smile, Greeting, Courteous and Polite and utter Assalamualaikum. The receptionist asked guests booking process, guest check-in process helped the same time a procedure shown to be an agreement was signed and agreed upon by the guests as not allowed to smoke in all areas of the hotel and, if found in violation will be fined \$ 1.5 million, may not take photos for commercial purposes. The check in process is done at 15:00 and checked out at 13:00, after the check in guests get a welcome drink and fruit dates.

The process here was also attentive to the needs of internal employees as to how the company treats its employees. Work atmosphere at Hotel Noor made as comfortable as possible with the principles of family leadership, which is very attentive to the needs of special needs guests such as financial and nonfinancial needs. At Hotel Noor in addition to compensation for wages and salaries, employees also get employment insurance, family gathering with office and several other facilities.

Tangible

Physical evidence is one thing that may be seen with the naked eye and can be directly measured by consumers. The things that fall into the category of physical evidence, namely the exterior, interior, and other evidence in the form of an item or object. The exterior and interior of the building to a hotel-style sharia is not necessarily the Middle East to show the Islamic atmosphere, the important thing is not to break the rules of sharia on the physical appearance of the building. The exterior also includes the availability of parking spaces,



which are still limited parking space at Hotel Noor. Interior room at Hotel Noor shades of Tosca and special decoration for the moment there are certain moments such as Eid. There are many decorative calligraphies at the front desk and the hotel lobby corridor hotel room.

Other facilities at the hotel there is the presence of a small mosque facility that accommodates 25 people where the male and female ablution every available hotel rooms are separated. The prayer materials such as sejadah, mukena and also equipment such as the Koran and prayer beads. The total number of rooms there are 33 rooms consisting of deluxe numbered 21, there are 12 executive rooms. The meeting room there is no third biggest space can accommodate 100 people. Calligraphy inscribed with verses of the Koran are found in the public area and also laid carpet turkey so that the luxurious feel of the hotel appears to be seen. In sharia nuanced hotel facilities is not permitted gambling, smoking area and the availability of porn cable, and discotheque.

Promise

Hotel Noor offers a range of promises to attract visits by tourists. The promise of these promises can be seen on web pages or pages Online Booking Website promotion through such web Cheapest Hotels booking.com, traveloka, tripadvisor, pegipegi and several websites online booking. Hotel Noor promising room facilities, provision of breakfast, pick-up service. Then there is wi-fi, air-conditioning, dining room, prayer room, and. The hotel is also close to the airport and shopping center and is located in the center of the city of Bandung is very strategic.

In the Islamic system promises spoken primarily had to abide by the Qur'an. The promise is something that absolutely must be met therefore be of no exaggeration in the promise to consumers. In this case the hotel Noor already understands these rules so that what was promised in accordance with the realized.

Patience

Patience in the face of the consumer is absolutely necessary. Patience is his key to a good major in communications. Many Qur'an verses that sent his servant to be patient include Sura 3: 146, QS, 3: 200, QS, 8: 46, Surah 16: 127 and many others. In the case of this patient



also explained that the implementation of sharia hotel marketing must be willing to listen to consumers and beneficial for the people. Based on interviews with the hotel manager Noor, lock their services in addition to prioritize quality of service is also patience in serving customers with different nature, because it does not rule out a variety of complaints came from consumers can lead to consumer emotions. Complaints or No complaints from consumers who otherwise there is a direct testimony delivered through booking.com, traveloka and others and was met by the hotel manager with a very responsive. If there are complaints that can not be solved, hotel will apologize and give a good explanation to the hotel guest who had the complaint.

CONCLUSION

Based on the results of research and discussion on the application of sharia marketing at Hotel Noor, it can be concluded that the Hotel Noor has implemented according to the rules of sharia Islamic principles. The application of Islamic principles of marketing is also in conjunction with the application of modern nuances modification makes sharia principles are no longer something that is considered old-fashioned or backward.

REFERENCES

- Ahmad Munzirin. (2009). Strategi Pemasaran Perspektif Syariah. *Jurnal Ekonomi Ideologis*. Vol. 3. No. 2. Maret 2009, hlm. 2-5.
- Bukhari Alma dan Donni Juni Priansa. *Manajemen Bisnis Syariah: Menanamkan Nilai dan Praktis Syariah dalam Bisnis Kontemporer*, Bandung: Alfabeta, hlm. 340.
- Departemen Agama RI. (2013). *Al-Quran Edisi 1000 Do'a*. Bandung: Al-Mizan Publishing House.
- Hejase, Hussin., Bassan Hamdar., Mohammed Orfali., and Ale Hejase. (2012). Marketing Mix: An Exploratory Research in Syria from an Islamic Perspective. *American Journal of Scientific Research*, December 2012: 33-52.
- Hermawan Kartajaya dan Muhammad Syakir Sula. (2008). *Syari'ah Marketing*. Bandung: Penerbit Mizan.



- Ita Nurcholifah. (2014). Strategi Marketing Mix Dalam Perspektif Syariah. *Jurnal Khatulistiwa –journal of Islamic Studies* Volume 4
- Kotler, Philip and Kevin Lane Keller. (2009). *Manajemen Pemasaran edisi 13 jilid 1*. Jakarta: Penerbit Erlangga.
- Moleong, Lexy J. (2011). *Metodologi Penelitian Kualitatif*. Bandung: PT Remaja Rosdaka
- Riyanto Sofyan. (2011). *Bisnis Syari'ah Mengapa Tidak?Pengalaman Penerapan pada Bisnis Hotel*. Jakarta: PT Gramedia Pustaka Utama.
- Saeed, Mohammad., Zafar U. Ahmed., and Syeda-Masooda Mukhtar. (2001). International Marketing Ethics from an Islamic Perspective: A Value-Maximization Approach. *Journal of Business Ethics*, July 2001:127-142.
- Shuhaimi, Mohd bin Haji Ishak and Osman Chuah Abdullah. (2012). Islamic Perspective on Marketing Mix. *International Journal of Business and Management Studies*, Volume 4, No. 2, 2012: 121-131.
- Sugiyono. (2009). *Memahami Penelitian Kualitatif*. Bandung: Penerbit Alfabeta
- <http://www.noorhotels.com/>



**THE AMENDMENT OF IAS 41: A SOLUTION FOR PLANTATIONS INDUSTRY IN
INDONESIA?**

Titania

Mariani

Teguh Tri Sugiarto

Thedy Dwi Prasetyo

Universitas Sebelas Maret

aiem.titania@gmail.com

Abstract

The purpose of this study was to analyze the theoretical aspects of the amendments of IAS 41: Agriculture. Based on the results of several other empirical researches, the impact of the adoption of IAS 41 is not as good as as expected. Rejection of IAS 41 emerged as cause's earnings volatility. The result of the amendment of IAS 41 is to modify one of the criteria in the definition of bearer plants. Bearer plants define as plants, which are used solely to grow produce over several periods. The IASB decided that bearer plants should be accounted for in the same way as property, plant and equipment in IAS 16 Property, Plant and Equipment, because their operation is similar to that of manufacturing. Consequently, the amendments include them within the scope of IAS 16, instead of IAS 41. However, the amendments are still not providing solutions to the weaknesses of the existing rules in IAS 41.

Keywords: IAS 41, IAS 16, biological asset

JEL Classification: M41

INTRODUCTION

Accounting is a technology used to process financial data so that it can create useful information for decision making. In this era of globalization, many companies that conduct economic activities in various jurisdictions. The consequence is, financial statements should be based on accounting principles which are not restricted by jurisdiction. It is intended for stakeholders from various parts of the world can have a common understanding of the



financial information presented. This is one of the background of the use of international reporting standards (IFRS). IFRS can provide financial information on a variety of economic practice in various jurisdictions. Therefore, IFRS is more based on principle than the rule-based. The concept of principle-based make IFRS can be used in a variety of business practices in various jurisdictions. The use of IFRS also make the financial reports can be compared with other financial reports across jurisdictions. This is very useful in improving global investment, as a user of financial statements (investor) will have the same understanding of the financial information presented.

Indonesia has set out to fully adopt IFRS early in 2012. Indonesia as a G-20 member states, should follow all the consequences that must be addressed in full upon adoption of the IFRS (Immanuela, 2013). Indonesia actually has its own accounting standards, namely Statement of Financial Accounting standards (SFAS). SFAS prepared and issued by IAI (Institute of Accountants Indonesia). Starting from the revision of the 1994 IAI has decided to harmonize standards SFAS towards IFRS (International Financial Reporting Standard). In the next stage, harmonization transformed into the adoption and adoption itself addressed in the form of convergence to IFRS. The IFRS convergence program to be done by the IAI to perform full adoption of international standards (IFRS and IAS).

In the IFRS, there are set of rules, one of which IAS 41 concerning biological asset. Condition of Indonesian territory is suitable for agriculture and plantations become the reason why the issue of biological assets reasonably be concerned. Measurement and presentation of the biological assets has become an interesting topic to talk about. This is attributable to the presence of disagreement about the precise method of measurement on this asset type for biological assets that have unique characteristics and different when compared to other types of non-current assets. Application of biological assets that exist in IAS 41 has been applied for more than 12 years in several countries and will be adopted in the countries that are now in the process of convergence with IFRS, including the Indonesia. IAS 41 contained in IAS 69 in Indonesia. SFAS 69 is the adoption of IAS 41 Agriculture, which became effective January 1, 2016. Prior to IAS rules adopted in Indonesia, IAS has undergone amendments. The amendment is expected to be a solution on the charge IAS 41 are considered Euro centric so it is not suitable to be applied in tropical regions such as



Indonesia, Malaysia, and India are the season and the weather is hard to guess, so as to conditions like this, it is difficult to be able to use the fair value.

Amendments to IAS 41 states that the IASB provides an exception only for the bearer plants (eg oil palm, rubber) to be measured in accordance with IAS 16: Property and Equipment. Oil palm trees analogous to a machine used to produce goods. Accounting measures for fruit produced remains to be measured at fair value in accordance with IAS 41. With the enactment of amendments to IAS 41 by the IASB, the agriculture industry in Indonesia should be prepared to deal with change. The next question arose, whether this amendment can be a solution for the plantation industry in Indonesia?

LITERATURE REVIEW

IAS 41 was published by the International Accounting Standards Committee in February, 2001. This standard prescribes the accounting treatment, financial statement presentation, and disclosures related to agricultural activity that are not covered by another standard. Agricultural activity is the management of the transformation of living animals or plants (biological assets) of an entity for sale, into agricultural products, or into additional biological assets. IAS 41 Agriculture prescribes the accounting treatment for biological assets during a period of growth, degeneration, procreation, and the initial measurement of agricultural produce at the point of harvest. IAS 41 does not regulate the management of agricultural products after harvest time, such as management of the grapes into wine, the management of wool into yarn (IAS 41: IN2). Definition of biological assets under IAS 41: "Biological asset is a living animal or plant". If it is associated with the characteristics possessed by the asset, then the biological asset can be interpreted as an agricultural crop or livestock owned by companies that obtain in the past.

Biological assets is a unique asset, because of the transforming growth even after biological assets generate an output. The transformation occurs in biological assets consist of processes of growth, degeneration, production, and procreation that can cause a variety of quantitative and qualitative changes in the life of the assets in the form of plants or animals. Biological assets can generate new assets embodied in the form of agricultural produce or additional biological assets in the same class. Their biological transformation of biological



assets, the necessary measurements to demonstrate the value of these assets appropriately in accordance with the agreement and its contribution in generating the flow of economic benefits for the company.

RESEARCH METHODOLOGY

This research is descriptive qualitative with the aim to provide a preliminary description of the IAS 41 and the amendments and then analyze the application of IAS 41 to be adopted in Indonesia. The source of the data used in this research is using secondary data. Secondary data is data obtained through documents or archives relating to writing in the form of rules, news and notes regarding the recognition and measurement of biological assets that already exist.

RESULT AND DISCUSSION

Overview Agriculture Indonesia

Extensive and abundant with fertile soil, Indonesia is a major producer globally from a wide range of products of tropical agriculture, and although agriculture's share of gross domestic product of the country (GDP) has declined sharply over the past five decades, but agriculture still providing income for the majority of Indonesian households, currently. In 2012, this sector employs about 49 million Indonesian people, who represent 41 percent of the total workforce Indonesia. But although the absolute number of agricultural labor force continues to grow, the relative share of the total workforce in Indonesia has declined significantly from 55 percent in 1980 to 45 percent in the 1990s and today is 41 percent. Only during the Asian financial crisis in the late 1990's, this portion grow significantly as unemployment in both the industrial and services sectors absorbed by the agricultural sector.

Between the mid-1960s and mid-1980s the percentage of land area in Indonesia which is used for agriculture remained constant at around 21 percent of the total land area of Indonesia. However, in the mid-1980s this number increased to nearly 25 percent until the end of the 1990s. Starting in 1998 this number changed (due to the formation of large-scale plantations, in particular palm oil) making it reached its current level of 30 percent. The



agricultural sector in Indonesia is expected to continue growing. The agricultural sector of Indonesia consists of large estates (both state and private) and small farmers. Large estates tend to focus on commodities which are important export products (oil palm and rubber), whereas small farmers focus on rice, soybeans, corn, fruits, and vegetables. The most important agricultural products of Indonesian oil palm, rubber, cocoa, coffee, and tea (www.indonesia-investments.com).

Critics of the Concept of Biological Assets

Under IAS 41, the agricultural activity can be defined as an activity undertaken by an entity on the biological transformation and harvest of biological assets for sale or for conversion into agricultural product or into other biological assets. Biological transformation includes the process of growing, degeneration, production, and procreation that result in changes in quality and quantity on a biological asset itself. Biological assets are measured on initial recognition and at the end of the period at fair value less cost of sales (net realizable value). The company recorded gains and losses on the net realizable value. Asset generated when the harvest is an asset of the results of biological assets such as wool produced by lamb, milk resulting from dairy cows, or fruits produced from fruit crops. These products are measured at fair value less cost of sales (net realizable value) at the time of harvest (Kieso, 2012).

Biological assets should be assessed at initial recognition and at each balance sheet date using fair value. According to IAS 41, an entity that has a biological asset can recognize biological assets and agricultural products when and only when the entity is in control of those assets as a result of a past event, is likely to benefit economically in the future associated with an asset, as well as fair value or cost of the asset can be measured reliably. Agricultural products resulting from the harvest of biological assets be measured at fair value less estimated point-of-sale costs at harvest. To measure the biological assets, we could use fair value (fair value) as set out in IFRS, the assessor can apply three (3) approaches, namely the market (market data approach), the cost approach, and the income approach.

Gains or losses arising on initial recognition of a biological asset at its fair value less costs to sell and changes in fair value less costs to sell is recognized as income in the period



in which the gain or loss occurs. Any entity or company that earlier measure the biological asset at fair value less estimated costs to sell should continue to measure the biological asset at its fair value less estimated costs to sell the asset to be exchanged (disposal). Likewise, agricultural products in which the gain or loss arising on initial recognition of agricultural products at fair value less costs to sell is recognized as income in the period in which the gain or loss occurs. Along with the application, IAS 41 was not so easy to implement. This is evidenced by some of the results of previous studies listed in Table 1.

Table 1. Previous Study of IAS 41

No	Previous Study	Results
1.	Aryanto (2011): Theoretical Failure of International Accounting Standard 41	<p>Theoretical Failure of International Accounting Standard 41 (IAS 41) should be revisied. Aryanto (2011) states that there is a failure of the application of IAS 41 for the adoption of IAS 41 is not as good as expected. Overall, IAS 41 has failed to achieve its objectives, namely to increase the comparability of financial statements in the agricultural sector. Here are some examples:</p> <ul style="list-style-type: none"> ● The fair value model, there are different models used as the market approach (market approach of data), the cost approach (cost approach), and the income approach (income approach). The use of different models leads to different measurement of the quality of earnings in the agricultural sector internationally. ● In many tropical countries, the fair value is determined by market authorities do not reflect the fair value of commodities such as coffee, tea, bananas, and cocoa. Not all stakeholders can receive fair value (or the world market price).

2.	Elad dan Herbohn (2011): Implementing Fair Value Accounting in The Agricultural Sector	<p>The results of the research include:</p> <ul style="list-style-type: none"> • IAS 41 does not have a significant impact on agriculture accounting for the small and medium entities. IAS 4, has created the illusion of comparability. The fair value is determined by market forces does not reflect the real value of agricultural commodities, such as coffee, tea, and chocolate. Not all can be accepted that the fair value of agricultural crops is a fair price, which reflects the true value. • There are systematic differences in the accounting policy choice of agricultural entities that have adopted IAS 41 in Australia, France, and England. Historical cost is still the most common basis of assessment for biological assets in France, while a variety of proxy fair value is used in Australia and the UK. 9 out of 17 companies in France have adopted IAS 41 by assessing biological assets they are using the cost method (cost) while the present value of net cash flows of the future is a method that is more widely used in the UK and Australia, and often engage the services of external assessors independent , especially in the forestry and plantation agriculture.
3.	Kurniawan et al (2014): Biological assets valuation reconstruction: A critical study of IAS 41 on agricultural accounting in Indonesian farmers	<p>Kurniawan et al (2014) case study in Indonesia and highlights the suitability of the implementation of IAS 41 with the farm life in Indonesia. This paper discusses the weaknesses contained in IAS 41:</p> <ul style="list-style-type: none"> • IAS 41 using the concept of accretion on the fact that not all biological assets have a cycle like the concept of accretion. In theory (IAS 41), biological assets generalized using the concept of accretion. • IAS 41 also concerned only with the economic aspect. The emergence of IAS 41 shows farming will be brought into

		<p>the realm of business a profit-oriented while agriculture is not only economic activities to generate income alone, more than that farming is a way of life most of Indonesian farmers. Money is one of the most comprehensive utility to be measured. But there are other utilities such as energy, thoughts, beliefs, trust, and other abstract utilities that cannot be measured in accounting.</p>
--	--	---

Amendments to IAS 41 Bearer Plants

Based on the explanation and the results of previous studies that have been discussed above, it can be concluded that the application of IAS 41 in full on biological assets and agricultural products are still experiencing various difficulties. IAS be adopted in Indonesia by IAS 69 will be the result of amendment by the IASB that have been passed in June 2014. in accordance with the commitment of the Financial Accounting Standards Board of IAI to keep a gap of one year between IFRS and GAAP, it is likely DSAK-IAI will soon be adopting IAS 41 on the effective date is January 1, 2017. There are several aspects have been amended in IAS 41 so as to provide a solution for the implementation of IAS 41 that the concept of accretion. Not all biological assets have a cycle like the concept of accretion. Accretion concept can be applied to biological assets in the form of trees that will be used later on wood, such as teak. For biological assets in the form of a tree that was just taken his or animal milk or fur taken alone, can not use the concept of accretion. This is because the purpose of a biological asset type is to produce something of the treatment process and production, making it less likely to be sold and is recognized as a plant ready for sale as it did in teak.

IASB decided that productive crops must be taken into account in the same way as property, plant and equipment in IAS 16 because their operation is the same as manufacturing. Some plants, for example, tea plants, vines, palm trees and rubber trees, meet the definition of productive plants (plants bearer) and are included in the scope. IAS 16: Property and Equipment. However, products that grow (produce growing) on productive plants (plants bearer), for example, leaf tea, grapes, fresh fruit bunches of oil palm and rubber



latex, are included in the scope of IAS 69: Agriculture. Excluded from the bearer crop plants, ie plants cultivated to be harvested as agricultural products (for example, trees planted to be used as a piece of wood); cultivated plant to produce agricultural products when there is a possibility that it is rare that the entity will also harvest and sell crops such as agricultural products, and seasonal crops (annual crops), such as corn and wheat, and the remaining sales of productive plants that are no longer used to generate agricultural products. A brief explanation IAS 41 before and after the amendment can be seen in Table 2.

Table 2. IAS 41 (Before and After Amendment)

		Before Amendment	After Amendment
Productive Plants	Initial Recognition	<ul style="list-style-type: none"> ● Measured along with the results of farm attached (ie, one unit of account). ● Measured at fair value less costs to sell. 	<ul style="list-style-type: none"> ● Measured separately from any agricultural product that is attached (ie, two units of account). ● Measured at historical cost, accumulated until maturity.
Agricultural Product	At the end of each reporting period	Measured together with productive crops.	Measured separately from productive crops at fair value less costs to sell
	At the harvest time	measured separately from productive crops at fair value less costs to sell	

But unfortunately, the results of the amendment does not provide significant solutions. The implementation of IAS 41 is still difficult to do, especially in the industrial estates in Indonesia. IAS 41 is one of the standards that is a wedge in Malaysia, Indonesia

and India in the full adoption of IFRS (iaiglobal.or.id). Some difficulties faced in implementation of IAS 41, namely:

- a. IAS 41 requires that all biological assets are measured at fair value and the difference is entered into the income statement. IASB also requires that biological assets that have not been harvested and still attached to the BBA (Bearer Biological Asset) measured by the fair value method. For biological assets that have not been harvested, it will be very difficult to apply the fair value method, for example only, it is very difficult to measure the rubber latex is still in the rubber tree.
- b. As mentioned above, it is set in IAS 41 before the amendments, biological assets are treated as productive crops and its agriculture products as unity assets up to the point of harvest. Amendments to IAS 41 to separate the two in order to recognize the productive plant apart from agricultural products prior to harvest. The question is, how to determine the point at which agricultural products are measured separately from the productive plant? This will require a judgment. For example, on agricultural products began to grow in productive plant, at that time whether to be treated as a separate agricultural products? Until now, there has been no definite provision.
- c. In IAS 41 also regulates the recognition, disclosure and measurement of biological assets along with their products (such as an orange tree with its orange fruits). Measurements of biological assets as well as their products are measured at fair value or fair value. Assets and their products are treated equally in terms of the measurement is fair value less the cost of sales. In IAS 41 the difference in change in fair value less costs to sell unrealized recognized in the income statement. The impact of the recognition of the difference in change in fair value less costs to sell any unrealized profit and loss in this is the increasing volatility of financial performance that actually have not been realized. If seen, as if the profit generated by the financial statements will become apparent profit. Profit apparent this is definitely a major impact for certain biological assets that have different characteristics, such as the timber which requires a very long time to be able to



harvest. In the case of teak, in general, an oak tree takes about 25 years since grown to be ready for harvest. The actual revenue reflects an increase in the value of teak trees will occur after 25 years. In fact, according to IAS 41, an entity which has a teak tree must acknowledge the increase in unrealized or decrease in revenue in the statement of income for 25 years, and this kind of information would be misleading (Aryanto, 2011).

CONCLUSION

The passage of a biological asset accounting by the IASB through the IAS 41 accounting has changed domestic nature into global accounting (Mates and Grosu, 2008); (Lefter and Roman, 2007). IAS 41 explains the concept of biological assets agricultural activity measured at fair value. Difficulty assessing the fair value has been perceived by the various parties. The difficulty is due to the absence of a standard to establish the assessment of biological assets surely. Amendment of asset on IAS 41 which became the basis of IAS 69: Agriculture which is soon set in Indonesia have not been able to accommodate the treatment of biological assets. In connection with this, it is necessary to note the mechanism of assessment and understanding of IAS 41 oleh agricultural industry. For the IASB itself, should be able to accommodate the biological assets (in any properties and characteristics) that exist in all parts world. There only biological assets that exist in countries that are members of the IASB, so it can collect all the interests of each country that has different character.

REFERENCES

- Aryanto, Y.H. 2011. "Theoretical Failure of IAS 41: Agriculture." h..1-5. www.ssrn.com.
Diakses tanggal 15 Maret 2017, 14:20.
- Elad, C., & Herbohn, K. (2011). *Implementing fair value accounting in the agricultural sector*. Institute of Chartered Accountants of Scotland.
- <http://iaiglobal.or.id/v03/berita-kegiatan/detailarsip-574>
- [http://tempdata.iaiglobal.or.id/files/ED%20Amandemen%20PSAK%2016%20\(07%20Sept15\).pdf](http://tempdata.iaiglobal.or.id/files/ED%20Amandemen%20PSAK%2016%20(07%20Sept15).pdf)



- [http://tempdata.iaiglobal.or.id/files/ED%20PSAK%2069%20\(07%20Sept%202015\).pdf](http://tempdata.iaiglobal.or.id/files/ED%20PSAK%2069%20(07%20Sept%202015).pdf)
- <http://www.akuntanonline.com/showdetail.php?mod=art&id=660&t=IASB%20Lambat%20Revisi%20IAS%2041%20tentang%20Agriculture?&kat=Akuntansi>
- [http://www.ey.com/Publication/vwLUAssets/IFRS_Developments_Issue_84:_Bearer_plants_-_the_new_requirements/\\$FILE/Devel84-Agriculture-July2014.pdf](http://www.ey.com/Publication/vwLUAssets/IFRS_Developments_Issue_84:_Bearer_plants_-_the_new_requirements/$FILE/Devel84-Agriculture-July2014.pdf)
- http://www.ifrs.org/Current-Projects/IASB-Projects/Bearer-biological-assets/Documents/FINAL_Agriculture_Bearer%20Plants_JUNE%202014_WEBSITE.pdf
- <http://www.indonesia-investments.com/id/budaya/ekonomi/ikhtisar-struktur-ekonomi/pertanian/item378>
- https://www.academia.edu/4091611/Dampak_Implementasi_IFRS_BAGI_PERUSAHAAN_Oleh_Dwi_Martani_Staf_pengajar_Akuntansi_FEUI_anggota_tim_implementasi_IFRS
- Immanuel, I. (2013). KONSEKUENSI ADOPSI PENUH IFRS TERHADAP PELAPORAN KEUANGAN DI INDONESIA. *Widya Warta*, 36(02).
- Kieso, Donald E., Jerry J Weygandt, dan Terry D. Warfield. 2012. *Intermediate Accounting* Ed.14. John Wiley and Sons, Inc.
- Kurniawan, R., Mulawarman, A. D., & Kamayanti, A. (2014). Biological assets valuation reconstruction: A critical study of IAS 41 on agricultural accounting in Indonesian farmers. *Procedia-Social and Behavioral Sciences*, 164, 68-75.
- Lefter, V., & Roman, A. G. (2007). IAS 41 Agriculture: Fair value accounting. *Theoretical and applied Economics*, Vol. 5(510), pp. 15-22.
- Mates, D., & Grosu, V. (2008). *Lucrari Stiintifice, seria Agronomie: Evaluating and recognizing biological assets and agricultural activities according to IAS 41*. Vol. (51), pp. 457-462.



**AUDITOR SWITCHING'S FACTORS: THE ANALYSIS ON AUDIT DELAY,
CLIENT SIZE, AND AUDIT COMMITTEE CHANGES**

Meryka Kasih

President University Jabababeka

Evita Puspitasari

Universitas Padjadjaran Jl. Dipati Ukur No. 35 Bandung 40132 – Indonesia

+628156072882; evitapuspitagumilar@gmail.com; evita.puspitasari@unpad.ac.id

Abstract

Auditor switching is an event of changing public accounting firm. The purpose of this research is to analyze the effect of independent variables which are audit delay, client size, and audit committee changes toward the dependent variable which is auditor switching in all companies listed on Indonesia Stock Exchange from year 2012-2015.

This research uses logistic regression technique and using all companies listed on Indonesia Stock Exchange as the population. For the sample, it is chosen with using purposive sampling. The sample chosen is 156 companies listed on Indonesia Stock Exchange with 4 years of time period from 2012-2015 with total observation 624 data.

The result from the hypothesis testing showed that all the independent variables are simultaneously give significant effect the dependent variable. It was also found that client size partially has negative significant effect toward auditor switching, meanwhile audit delay and audit committee changes partially has positive but not significant effect the auditor switching.

Keywords: Audit Committee Changes, Audit Delay, Auditor Switching, Client Size

JEL Classification: M42



INTRODUCTION

In this globalization era, many developed companies from various type of industry appear in Indonesia. The size of the company is also in various scale form the small, medium, and also large company. Along with the appearance, almost all companies need funds whether from stakeholder or lend from creditors for their companies. For investors, they need relevant information and also actual representation to enable them to make comparisons for the efficiency of capital allocation (Kieso et al., 2011). One of elements that people can trust to decide whether to invest or lend their money is with financial reporting. According to Kieso et al. (2011), financial reporting has general purpose to afford financial information of the reporting firm that is useful to present and helpful for investors, lenders, and other creditors while make decision as capital provider in their proportion.

Financial reporting information is provided in the financial statement that prepared for various users. According to Khasharmeh (2015), the reliability of the financial report can provide information that is required by financial statement users such as manager, investors, creditors, and government. The financial statement users only can rely on the information given by the company, if the financial statement is audited and confirmed by objective and independent individual who is auditors in the public accounting firm. Independency of auditor is important ethical principal during the audit process.

Following about independency auditor for the reliable financial statement, still remember Enron Scandal? Enron scandal is scandal that shows about Arthur Andersen as one of big public accounting firm in that time in America (2002) fail to preserve their independency toward Enron as their client. There is moral hazard on Enron Scandal which one of them is Arthur Andersen involved on the manipulation of the financial report that recorded profit but the fact Enron is having loss.

Based on the scandal, the independency of auditor is become a question among public, but beside of that the needed of auditor is also still important and needed by all companies. The public is also only has auditor as the independent and objective individual that can be trusted by them to know whether they can rely on the company's financial statement or not. Regarding the Enron scandal, finally Sarbanes Oxley (2002) is established by Public Company Accounting Oversight Board (PCAOB). Sarbanes Oxley is primarily



designed to regulate company in attempt to assist the ethical behavior and inhibit fraudulent financial reporting (Godfrey et al., 2011). On Sarbanes Oxley, there's also regulation for public accounting firm and also audit partner.

Regarding of that, government in Indonesia also has regulation about auditor switching as mandatory following Sarbanes Oxley (SOX) 2002. For the first, Indonesian's government impose Keputusan Menteri Keuangan No. 423/KMK.06/2002 and changing become Keputusan Menteri Keuangan No. 359/KMK.06/2003 that stated a company must change their public accounting firm for audit in 5 years in a row. The newest version of the regulation is Peraturan Menteri Keuangan Republik Indonesia No. 17/PMK.01/2008 about "Jasa Akuntan Publik" article 3 paragraph 1 that regulate about given general audit service of financial report from entity done by Public Accounting firm maximum for 6 book years in a row and by a public accountant maximum 3 book years in a row. Beside of mandatory regulation, Auditor switching can also happen because of voluntary factors that appear between auditor-client relationships.

There are previous research that had already research about auditor switching. However, the results are not consistent one another. Research done by Chadegani, et al. (2011) about auditor switching in Tehran Stock Exchange showed client size has insignificant effect toward auditor switching. Beside of that, research done in Indonesia by Suparlan & Andayani (2010) found that client size has negative significant effect toward auditor switching which means has different result with research done by Chadegani et al. (2011).

For listed public company, company is obligated to submit their audited financial statement for the financial statement users. Research done by Stocken (2000) found that, audit task completion which has long range time will affected to the delay in the publication of financial statement to the capital market with the result it is affected to the auditor switching. Also research done in Indonesia by Pawitri & Yadnyana (2015) in real estate and property sector in IDX found that audit delay has significant effect toward auditor switching. As also in Indonesia, all public listed company on Indonesia Stock Exchange must have audit committee as stated on the management letter from Indonesia Stock Exchange No: Kep. 339/BEJ/07-2001. Research done by Sulistiarini & Sudarno (2012) with manufacture sector



as sample found that audit committee changes partially not give significant effect toward auditor switching.

Therefore, we try to elaborate the factors that that could affect the auditor switching. The factors that will be analyzed on this research are audit delay, client size, and audit committee changes. This research entitled “Auditor Switching’s Factors: The Analysis on Audit Delay, Client Size, and Audit Committee Changes”.

THEORETICAL FRAMEWORK AND HYPOTHESES DEVELOPMENT

Auditor Switching

Auditor switching is an event when the firms as client change their auditor (public accounting firm). Auditor has an important key role in pressing the risk of information which is the main economic reason behind audit and assurance service demand (Chadegani et al., 2011; Khasharmeh, 2015). According to Nasser et al. (2006) along with auditor rotation that is made, the audit tenure become shorter than before, the company will do auditor switching. Auditor switching can happen because of the regulation that is issued and published by the government. In Indonesia, the newest version of the regulation is Peraturan Menteri Keuangan Republik Indonesia Nomor 17/PMK.01/2008 about “Jasa Akuntan Publik” pasal 3 ayat 1 that regulates about given general audit service of financial report from entity done by Public Accounting firm maximum for 6 book years in a row and by a public accountant maximum 3 book years in a row. Due to the regulatory that published by Ministry of finance Indonesia as stated above, company changes their public accounting firm after 6 years of book year no had other reasons as it is a mandatory switching. Beside of the regulation factor, auditor switching is also influenced by others factor in terms of voluntarily switch the auditor (public accounting firm).

Beside of mandatory auditor switching, the factor of auditor switching can be seen from the side of company as client and also the side of the public accounting firm as it is auditor client relationship. Firm that changing their auditor will spend cost that is not supposed to spend out if still using the same auditor. As first time to audit in the new firm, auditor must start again to study and know the new client’s industry, client environment, and



set up audit risk. As it is auditor client relationship, there's a voluntary factor that involved when there's auditor switching.

Audit Delay and Auditor Switching

Audit report lag or audit delay is defined as the number of the days between a firm's fiscal year-end and its audit report date (Schwartz & Soo 1996). This definition is also been used by Nehme at al. (2015) that Audit delay or called also as audit report lag is a time between company's fiscal year-end and the audit report date. Audit delay is related to financial report that audited by the auditors. The length of audit delay is influenced by the difficulty of audit process (Pawitri & Yadnyana, 2015). According to

Azubike and Aggreh (2014), as the audited financial statements in the annual report are the only one source of information that reliable to investors, timeliness of audit report is important factor in appearing and newly developed capital market. When the timeliness of audit delay exceed the due time, it will create issue among public that the company is on the bad state that can impact the image of the company on Indonesia Stock Exchange.

Beside of the corporate image, audit delay can also impact toward the investor's reaction because investor presumption that the late financial report is a bad sign of the company's bad state in financial. In Indonesia, the regulation related to audit delay is made by BAPEPAM as capital market regulatory board. The regulation that issued on 2003 with the decision letter by head of BAPEPAM is Number Kep-36/PM/2003. Since BAPEPAM change into Otoritas Jasa Keuangan (OJK), the newest version of the regulation is OJK Regulation Number Kep-346/BL/2011 that stated annual financial report of public company that has been audited must be submitted to BAPEPAM at least in the third month after company's fiscal year end. It means that the submission of the audited financial report must be on 90 days after company's fiscal year end.

The length of audit delay is influenced by the complexity of audit process. Stocken (2002) stated that audit task completion which has long range time will affected to the delay in the publication of financial statement to the capital market with the result it is affected to the auditor switching. It is supported in the result of previous studies done by Pawitri and Yadnyana (2015) that audit delay has significant effect to auditor switching found that if the



publication of financial statements is postponed then the capital markets will suspicious and give negative evaluation that companies run into problems. Audit delay can impact to stock price and also public and investor's view. When audit delay happens, then many questions will be thought from investors and public about if the company has on the bad state.

According to Robbitasari and Wiratmaja (2013), the delay in publish the financial report might make the firm to change their public accounting firm since it will make suspicion toward financial report user and the firm doesn't want the audit delay happen on the next year. Therefore the first hypothesis is:

H1: Audit Delay has significant positive effect toward auditor switching

Client Size and Auditor Switching

According to Niresh and Velnampy (2014), Firm size is the number and various capacity of production and the capability of a firm to possess or the number and various service of a firm that can provide simultaneously to its customers. The size of the client firm can be described and showed based on total assets or total net sales. Client firm size can also be defined with number of employees and market capitalization. In the agency theory, it is exposed a fact that because of the asymmetrical information, the larger of a firm is, the higher also the inspecting and agency cost is (Zadeh & Eskandari, 2012). The greater the total assets, total net sales, number of employees and market capitalization, the greater the size of a firm itself. The larger asset of the firm, the more capital will flow to the company. In addition, the increasing of sales may also result the faster money turnover. Similarly with the market capitalization, the bigger it is then the company is more realizable and be recognized by public. From those, value of asset is the most stable to measure the firm size.

The choice of public accounting firm can be related to the size of the auditee firm. In research done by Chadegani et al. (2011) in Tehran Stock exchange, it was found that client size has insignificant negative relationship with auditor switching. Meanwhile, research done in Malaysia done by Nazri et al. (2012) found that client size has significant relationship with auditor switching. According to Willenborg, large firms will be forced to contract or change to larger public accounting firm as large firms are normally more complicated in operation and hence, expected to contracted auditors with more skill (Chadegani et al., 2011). Larger



auditee are less likely dismiss and change their auditor. Carcello et al., said the reason is because of the analyst of the financial and the financial press close examination to large firms' auditor dismissal and this factor might avoid larger firm from change their auditor as usually as smaller firm (Nazri et al., 2012).

As Watts & Zimmerman and Hudaib & Cooke say that it has been contended that the bigger auditees, because of the nature complexity of their operations and the expanded gap in the partition amongst management and proprietorship (ownership), request highly public accounting firm to lessen the agency costs and auditors' self-intrigue threat (Chadegani et al., 2011). Commonly, large firms have already hired and used audit service from public accounting firms which have high reputation such as big four. Based on agency theory, agent side will compare the cost with the benefit that will be obtained. The cost that will be used for using new public accounting service will be higher from benefit that could be taken because the start-up cost will increase the agency cost. It means that large firms have lower tendency to do auditor switching compared to the small firms. Therefore the second hypothesis is:

H2: Client Size has significant negative effect toward auditor switching

Audit Committee Changes and Auditor Switching

According to Liu and Sun (2010), in the firm, audit committee has an important role in overlooking, inspecting, and also recommending management and external auditor related in the preparing of financial statements, conducting audits, and performing internal systems of accounting control. Audit committee is a group that was form in the company to help do review and maintain the independency of accountant toward the management of the company. According to Ali (2014), due to the agency relationship between agent and the principal then the need of audit committees arises originally. Basically, Audit committee has duty to provide opinion toward board of commissioner about report or things that want to be delivered by the management to board of commissioner, identified matters that must be concerned by the commissioner, and perform other duties related to the duties of board of commissioner such as reviewing on performance of audit internal, observing and reviewing the competency and independency of external auditor. Through Audit committee has task to observe the external auditor's work while doing audit on the company and surely also has



own criteria regarding the chosen external auditor which become the favorite one that has already fulfil the standard and criteria to do audit on the company (Sulistiari & Sudarno, 2012).

Audit committee in the company has role to observe and review the processing of the financial reporting process on the company. According to Siegel, one of the purposes of the form of audit committee is to recommend on the selection of external auditor (Sulistiari & Sudarno, 2012). Audit committee must approve all non-audit or audit services and audit committee also has responsible to observe the auditor's work, including resolution of the disagreement between management and auditor involved the financial reporting (Arens et al., 2012). Audit committee also has criteria to grading the external auditor choice that audit committee like and has fulfill the standard and it will influence that audit committee changes will impact to change audit firm from he previous one (Sulistiari & Sudarno, 2012). Therefore the third hypothesis is:

H3: Audit committee changes has significant positive effect toward auditor switching

RESEARCH DESIGN

Empirical Design

This research has objective of examining the influence of audit delay, client size, and audit committee changes toward audit delay.

Below is the research model that we use in this study:

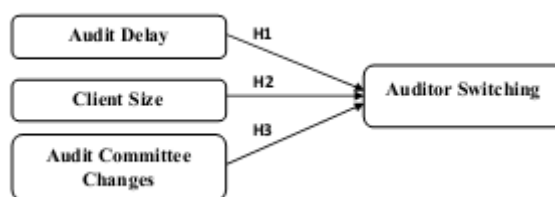

Figure 1

Auditor Switching

The measurement for auditor switching is dummy variable which if there's public accounting firm changes the given value is 1, meanwhile 0 is given if there's no public accounting firm changes.



Audit Delay

Audit delay or audit report lag is measured by seeing the total date closing of company's book which is December 31 st until the date of auditor sign the audited financial report (measured with number of days). This measurement is used commonly as audit delay or audit report lag measurement on literature review (Nehme et al., 2015). It has already been used before by Pawitri & Yadnyana (2015).

Client Size

Nasser et al. (2006) stated that client firm size can be measured based on total asset because the bigger total asset is then the larger also the firm size. Measurement for client size is using natural logarithm of total asset. This measurement has already been used before and as the total asset is the stable one (Chadegani et al., 2011; Suparlan & Andayani, 2010; Nasser et al., 2006).

Audit Committee Changes

Audit committee's regulation is published by PT. Bursa Efek Jakarta so that audit committee is formed in a company. Using measurement from previous research (Sulistiarni & Sudarno 2012), if the audit committee change the given value is 1, if not the given value is 0.

Hypothesis Testing

This research aims are to find empirical evidence of the objective of examining the influence of audit delay, client size, and audit committee changes toward audit delay. To achieve that, we perform regression logistics analysis method to examine the hypotheses and use the help of EVIEWS 9.0.

Therefore, the equation model using multiple linear regressions with for this research is as follow:

$$\text{AUSWITCH} = \beta_0 + \beta_1. \text{AD} + \beta_2. \text{LNTA} + \beta_3. \text{AC} + e$$



Description:

AUSWITCH: Auditor Switching

β_0 : Constanta

$\beta_1, \beta_2, \beta_3$: Coefficient of Independent Variables

AD: Audit Delay

LNTA: Client Size (Ln Asset)

AC: Audit Committee Changes

e: Error term

Sample

The data that is gathered from Indonesia Stock Exchange (IDX)'s website (www.idx.co.id) and take the audited financial statements of each company listed there. The information in IDX website and in the audited financial statements are used to analyze the influences of independent variables toward the dependent variable in this study.

Data panel is used to measure the variable which combine time series and cross sectional data. The time series data that will be used is 4 years started from 2012 until 2015. While, the cross sectional data is the number of companies mixed sector. Therefore, this research will observe and analyze data in total of 156 companies and it is equal to 624 data in total.

RESULTS

Descriptive Analysis

Auditor Switching (AUSWITCH)

Auditor switching (AUSWITCH) was measured with dummy variable with given value 1 if there were auditor switching and 0 if not. From the data, the result of dependent variable frequencies were 402 observations; with percentage 64.42% were not doing auditor switching meanwhile 222 observations with percentage 35.58% were doing auditor switching. From the result of descriptive statistic on table 4.2, the mean of 28 this variable



was 0.355769 with standard deviation value 0.479130. The minimum number which was equal 0 meanwhile the maximum number is equal to 1.

Audit Delay (AD)

Audit Delay (AD) showed the number of the days between a firm's fiscal year-end and its audit report date. From the result of descriptive statistic data, the mean of this variable was 80 days which means that average of auditor independent letter issued was 80 days after firm's fiscal year-end with standard deviation value 20 days. The shortest day of the auditor independent letter issued after firm's fiscal year-end is 15 days which was Adira Dinamika Multifinance Tbk that was audited by Ernest & Young and the longest day is 180 days which was Benakat Integra Tbk that was audited by BDO.

Client Size (LNTA)

Client size (LNTA) measured with the natural logarithm of total asset. From the descriptive statistic data, the mean of client's size on this research was Rp 17,196,803,231,150 (27.87338) with standard deviation Rp 76,703,585,733,287 (2.048065). The smallest client size on this research was PT Rimo International Lestari Tbk in 2013 with total asset amounted Rp 5,081,024,411 (22.3488) and the largest client size on this research was Bank Mandiri in 2014 with total asset amounted Rp 855,039,673,000,000 (34.38217).

Audit Committee Changes (AC)

Audit Committee Changes (AC) measured with dummy variable with given value 1 if there were changes on audit committee and 0 if not. From the data, the result of variable frequencies of audit committee changes was that there are 497 observations sample with percentage 79.65% were not having audit committee changes. Meanwhile 127 observations sample with percentage 20.35% were having audit committee changes. From the result of descriptive statistic data, the mean of this variable was 0.203526 with standard deviation value 0.402943. The minimum number which was equal to 0 meanwhile the maximum number was equal to 1.



Results

From the result, it was shown that the probability value for variable Client Size (LnTA) gave negative and significant effect toward auditor switching partially statistically with probability value of 0.0252. However, variable Audit Delay and Audit Committee Changes showed positive hence statistically insignificant effect toward auditor switching with probability 0.1492 and 0.6795.

DISCUSSION

The Effect of Audit Delay Towards Auditor Switching

From the result, it showed that audit delay gives positive, but insignificant statistical effect toward auditor switching. Since the p-value was more than 0.05 which is equal to 0.1492. The result proved that audit delay in partial and statistical did not give significant effect toward auditor switching. Then hypothesis one (H1) was rejected. This result is not in accordance with the previous research that done by Pawitri & Yadnyana (2015) which stated that audit delay in partial give positive and significant effect toward auditor switching. It could be explained that if audit delay was high then the auditor switching will also high but the effect was not significant to the auditor switching. If the auditor could finish the independent audit report, it can be said that it was still decent to still use the service of the same public accounting firm.

Meanwhile, if the longer auditors finished the audit report, the firms tended to change the previous auditor with the new one. But this situation did not always happen. If the auditor finished the audit report still on the range time that issued by Otoritas Jasa Keuangan (OJK) which was not more than 90 days after the year end closed book, the firm will think again before changing the auditor. Since there's a probability changing auditor would also take risk as the new auditor should understand more the new client and could cause also more audit delay because it would take more time to do audit.

Beside of that, in the sample of this research, audit delay had mean amounted 79.93109 or 80 days. It could be explained that the firm as the sample of this research had



average time 80 days to submit their audited financial statement which is under 90 days and still on the range time set by Otoritas Jasa Keuangan..

The Effect of Client Size Toward Auditor Switching

From the result, it shows that client size gave negative, but significant statically effect toward auditor switching. Since the p-value was less than 0.05 which was equal to 0.0252. The result proved that client size did give negative significant effect toward auditor switching. It could be concluded that second hypothesis (H2) in this research was accepted.

The result was not in accordance with Chadegani et al. (2011) that found client size gave negative insignificant effect and also with Nazri et al. (2012) that found client size had positive significant effect toward auditor switching. But the result from this research was accordance with Suparlan & Andayani (2010) that client size was give negative significant effect toward auditor switching.

On this research, regression coefficient of client size (LnTA) had negative influence toward auditor switching, in where client with smaller total asset more often changing their auditor. Meanwhile larger firm tended to not doing auditor switching compared to small firm. The larger a firm, they pretended not to change public accounting firm because commonly larger firm had already used assurance service from big public accounting firm such as big 4. It would also make large firm to spend more cost if they changed their public accounting firm because a large firm had more complexity; that the firm bared the fact that process of audit would start from the beginning because new auditor had to understand more client business risk and understanding financial condition of their new client.

It is along with Watts & Zimmerman and Hudaib & Cooke that said larger firm because of their nature complexity of their operation request highly public accounting firm to lessen the agency cost and auditors' self-intrigue threat (Chadegani et al., 2011). Also According to Suparlan and Andayani (2010), with the complexity of the auditee, larger client mostly did not changed their public accounting firm because client believed that the previous public accounting firm is easier to understand the situation and condition of the client's firm, meanwhile the smaller client firm prompted to change their public accounting firm and found public accounting firm with not expensive fee.



On this research, it was strengthen with observation that we had done about client size and auditor switching. PT Rimo International Lestari Tbk. (RIMO) as the smallest client firm size on this research that on trade, service, and investment sector on 4 years they already changed their public accounting firm. On 2011, the firm use KAP Achmad, Rasyid, Hisbullah & Jerry and change their KAP on 2012 to KAP Hasnil, M. Yasin & Rekan and still on 2013. On 2014, the firm used assurance service from KAP Jamaludin, Ardi, Sukimto & Rekan and still on 2015.

The Effect of Audit Committee Changes Toward Auditor Switching

From the result, it showed that audit committee changes gave positive, but insignificant influenced toward auditor switching. Since the p-value was more than 0.05 which was equal to 0.6795. The result showed that audit committee changes did not give significant effect toward auditor switching. In this research, the regression coefficient of audit committee changes was positive, which meant that the more audit committee change, the higher also the company would change their auditors. It could be concluded that H3 was rejected since the p-value was more than 0.05.

The result of this research showed that the changes on audit committee in the firm not suddenly make the audit committee to change their auditor to the new one. Especially when the company had already used audit service from public accounting firm with good reputation and understand more about their financial condition of the company. It was also supported by Beattie and Fearnley (1998) that found generally audit committee had played a passive role in the process of auditor change in tendency. The changes on audit committee did not give influence for pointing new public accounting firm which was different from the previous one. This result was in accordance with previous research done by Sulistiarini & Sudarno (2012).

CONCLUSION & IMPLICATION

Audit delay had positive insignificantly effects toward auditor switching. This result showed that the longer auditor released the independent auditor report, the higher also the auditor switching even it was not significantly influence the auditor switching.



Client size has negative significantly effects toward auditor switching. This result showed that the larger a firm, the lower also auditor switching happened. Larger company had lower tendency to change their auditor compared to small company.

Audit committee changes had positive insignificantly effects toward auditor switching. This result showed that the higher audit committee changes, the higher also auditor switching happened. But statistically, it was not significantly influencing the auditor switching.

Public accounting firm/auditors could keep the independency that they already had right now and increasing the quality of audit and also that public accounting firm/auditors could keep their timeliness on finishing the audited financial report. Public accounting firm/auditors could also join or hold various activities such as seminar or training about the updated regulation, PSAK, and others. From that, it was hoped that auditors and public accounting firms can give assurance service better to client firm than before.

REFERENCES

- Ali, A. A. (2014). Corporate Governance: The Role and Effectiveness of the Audit. *International Journal of Business and Management*, 131-137.
- Arens, A. A., Elder, R. J., & Beasley, M. (2012). *Auditing and Assurance Services: An Integrated Approach*. New Jersey: Pearson Prentice Hall.
- Azubike, J., & Aggreh, M. (2014). Corporate Governance and Audit Delay in Nigerian Quoted Companies. *European Journal of Accounting Auditing and Finance Research*, 22-33.
- Beattie, V., & Fearnley, S. (1998). Audit market competition: auditor changes and the impact of tendering. *The British Accounting Review*, 261-289.
- Chadegani, A. A., Mohamed, Z. M., & Jari, A. (2011). The Determinant Factors of Auditor Switch among Companies Listed on Tehran Stock Exchange. *International Research Journal of Finance and Economics*, 158-168.
- Ghozali, I. (2011). *Aplikasi Analisis Multivariate dengan Program IBM SPSS 19*. Semarang: Badan Penerbit Universitas Diponegoro.



- Godfrey, J., Hodgson, A., Tarca, A., Hamilton, J., & Holmes, S. (2010). *Accounting Theory*. Queensland: John Wiley & Sons Australia, Ltd.
- Gujarati, D. (2003). *Ekonometrika Dasar*. Jakarta: Edisi Terjemahan, Erlangga.
- Hair JR, J. F., Black, W. C., Babin, B. J., & Anderson, R. E. (2010). *Multivariate Data Analysis*. New Jersey: Pearson Prentice Hall.
- Keuangan, K. (n.d.). Retrieved from Sekretariat Jenderal - Kementerian Keuangan: <http://pppk.kemenkeu.go.id/Dokumen/Details/44>
- Khasharmeh, H. A. (2015). Determinants of Auditor Switching in Bahraini's Listed Companies - An Empirical Study. *European Journal of Accounting, Auditing and Finance Research*, 73-99.
- Kieso, D. E., Weygandt, J. J., & Warfield, T. D. (2011). *Intermediate Accounting*. John Wiley & Sons, Inc.
- Liu, G., & Sun, J. (2010). Director Tenure and Independent Audit Committee Effectiveness. *International Research Journal of Finance and Economics*, 176-189.
- Nasser, A. T., Wahid, A. E., Nazri, S. N., & Hudaib, M. (2006). Auditor-client relationship: the case of audit tenure and auditor switching in Malaysia. *Managerial Auditing Journal*, 724-737.
- Nazri, S. N., Smith, M., & Ismail, Z. (2012). Factors influencing auditor change: evidence from Malaysia. *Asian Review of Accounting*, 222-240.
- Nehme, R., Assaker, G., & Khalife, R. (2015). Dynamics of Audit Lag - Board of Directors and Audit Committees' Effect. *Corporate Ownership & Control*, 281-294.
- Niresh, J. A., & Velnampy, T. (2014). Firm Size and Profitability: A Study of Listed Manufacturing Firms in Sri Lanka. *International Journal of Business and Management*; Vol. 9, No. 4, 57-64.
- Pawitri, N. M., & Yadnyana, K. (2015). Pengaruh Audit Delay, Opini Audit, Reputasi Auditor dan Pergantian Manajemen pada Voluntary Auditor Switching. *E-jurnal Akuntansi Universitas Udayana*, 214-228.
- Robbitasari, A. P., & Wiratmaja, I. D. (2013). Pengaruh Opini Audit Going Concern, Kepemilikan Institusional, dan Audit Delay pada Voluntary Auditor Switching. *E-Jurnal Akuntansi Universitas Udayana*, 652-665.



- Sarwono, J. (2016). *Prosedur-Prosedur Analisis Populer Aplikasi Riset Skripsi dan Tesis dengan Eviews*. Jakarta: Penerbit Gaya Media.
- Schwartz, K. B., & Soo, B. S. (1996). The Association Between Auditor Changes and Reporting Lags. *Contemporary Accounting Research*, 353-370.
- Sekaran, U., & Bougie, R. (2013). *Research Method for Business*. Wiley.
- Stocken, M. E. (2000). *Auditor Conservatism and Opinion Shopping: Influence of Client Switching Expectations on Audit Opinion Decision*. The Pennsylvania State University.
- Sulistiarni, E., & Sudarno. (2012). Analisis Faktor-Faktor Pergantian Kantor Akuntan Publik (Studi Empiris pada Perusahaan Manufaktur di Bursa Efek Indonesia Periode 2006-2010). *Diponegoro Journal of Accounting*, 1-12.
- Suparlan, & Andayani, W. (2010). Analisis Empiris Pergantian Kantor Akuntan Publik setelah ada Kewajiban Rotasi Audit. *Simposium Nasional Akuntansi XIII Puwokerto*.
- Zadeh, F. O., & Eskandari, A. (2012). Firm Size As Company's Characteristic and Level of Risk Disclosure: Review on Theories and Literatures. *International Journal of Business and Social Science*, 9-17.



Table Summary of Sample

Company that listed on IDX before January 2012	427
Company that the financial statement or annual report not complete	(44)
Company that not doing auditor switching	(227)
Sample per year	156
Sample period 2012-2015 (156 x 4 years)	624

Industry Type	Sample number	percentage
Financial	32	21%
Manufacture	40	26%
Mining	19	12%
Agriculture	7	4%
Property	14	9%
Service	14	9%
TSI	30	19%
Total	156	100%

Table Descriptive Statistics

Variable	N	Maximum	Minimum	Mean	Std. Deviation
AUSWITCH	624	1	0	0.355769	0.47913
AD	624	180	15	79.93109	19.8011
LNTA	624	34.38217	22.3488	27.87338	2.048065
AC	624	1	0	0.203526	0.402943

Indicator Value	Count	Percent
Auditor Switching		
0	402	64.42 %
1	222	35.58 %
All	624	100 %
Audit Committee Changes		
0	497	79.65 %
1	127	20.35 %
All	624	100 %

Table Logistic Regression Analysis Results

Variable	Coefficient	z-Statistic	Prob.	Effect
AD	0.006279	1.442485	0.1492	Not significant
LNTA	-0.09646	-2.238639	0.0252	Significant
AC	0.086338	0.413203	0.6795	Not significant

Table Coefficient of Determination (Adjusted R²) Result

Pseudo R-squareds	
Cox-Snell	0.014039
Nagelkerke	0.019285

**DO COMPANY'S ATTRIBUTES AND AUDIT RELATED FACTORS AFFECT
TIMELINESS OF FINANCIAL REPORTING?**

Alvin Hary Septiyan

President University Jabababeka

Evita Puspitasari

Universitas Padjadjaran Jl. Dipati Ukur No. 35 Bandung 40132 – Indonesia

evitapuspitagumilar@gmail.com; evita.puspitasari@unpad.ac.id

Abstract

A useful financial information should have a relevance and faithful representation in order to help the users to achieve their objectives and timeliness is one of the qualitative characteristics to enhance this usefulness of financial information. In Indonesia all public companies are regulated by OJK to publish their audited financial statements regularly with their regulation number Kep-346/BL/2011. Hence, there are companies that are late in publishing their financial statement. Therefore, this research aims to examine the influence of Company's Attributes and Audit Related Factors toward Timeliness of Financial Reporting.

This research is done by examining financial statements of 80 companies listed in Indonesia Stock Exchange with 4 years of observation from 2012 – 2015 with total observation of 320 data. The research was done by using panel data with fixed effect model.

The results from hypothesis testing found that all independent variables were simultaneously significant in influencing the dependent variable. Profitability, Audit Opinion and Audit Firm partially gave significant effect in influencing Timeliness of Financial Reporting. However, there was no empirical evidence regarding Size of Company in affecting Timeliness of Financial Reporting.

Keywords: *Timeliness of Financial Reporting, Size of Company, Profitability, Audit Opinion, Audit Firm.*

JEL Classification: *M42*



INTRODUCTION

The needs of business information regarding the company's financial conditions is necessary for taking decision by internal or external users as for instance management, investor and creditor, Kieso et al, (2011). Therefore, every company will create their year-end financial statements, as the users of financial statements will need a trustworthy and reliable information regarding the company's conditions to make the right decision. Financial statement also will show the management responsibility of how they manage company's resources according to IAI, (2012). For instance, when the investors are going to invest their money to the company or whether the creditors are going to lend their money to the company.

Every company that has been listed in Indonesia Stock Exchange has an obligation to create and publish their audited financial statement regularly. Otoritas Jasa Keuangan (OJK) who act as supervisor and regulator for all financial services activity sector in banking, non-banking, capital market and other financial services also arrange a regulation to publish entity's financial statements to public based on OJK Regulation Number Kep-346/BL/2011 and also through UU No. 8 year 1995 about capital market. The regulation states that public companies must submit and publish their financial statements accompanied by the auditor's report regarding the audited financial statements no later than the end of third month or 90 days after the end of the date of financial statements.

However, even with the existing rules and regulations related to timeliness of financial reporting, there are some companies that were not submitting their audited financial statement in time. According to Indonesia Stock Exchange, in 2012 there were 52 companies that were late in submitting their audited financial statement. In 2013 there were 49 companies and in 2014 there were 52 companies recorded that were late in submitting their audited financial statements and they were given written warning I. Moreover, there were 18 companies in 2015 that is given a III written warning and a penalty of Rp. 150.000.000,- since until June 2016 thus companies has not submitted their audited financial statements.

According to the IFRS Framework, the fundamental characteristics of a useful financial information is having relevance and faithful representation. One of the qualitative characteristics that must be present to enhance the financial information is timeliness.



Timeliness expressed that the information presented is able to be used by the decision-makers in time so that the information will be considered in the decision making process and have effect to the decision stated in Kieso et al, (2011). According to Turel, (2010) in capital market timeliness is the essential thing to be present. When a lateness in reporting financial statements occurs, it raise the uncertainty that might affect the decision of investment. The content and relevancy of the information will be reduced when there is a delay.

Companies have to adjust their timeliness of reporting with the financial statements that is reliable. Timeliness is important factor because most of the financial statements users especially the stock holders and investors who are potential usually will use the information in financial statements before they decide whether they still want to be the stockholder or change their mind to be investor in a company (Hashim & Rahman, 2010).

Research regarding timeliness has been conducted by Turel (2010) that investigates company specific and audit related factors on timeliness of financial reporting in Turkey. The findings show that companies, which report net income and have standard audit opinion, will publish their financial statements earlier while the companies audited by the big four audit firms report their financial statements later. Another research in Indonesia done by Primantari (2016) shows that size of company, profitability and audit quality have significant effect on the timeliness of annual financial reporting. In the research, a company audited by big four audit firms tend to be timelier in reporting the financial statements. It is also found that company who has higher profitability tend to be timelier in reporting their financial statements. In addition, the variable control of the research which is company size shows negative significance relation to timeliness.

In this research, some factors that affect timeliness of financial statements reporting are re-analyzed in order to get the further evidence regarding the timeliness issue. Those factors will include company's attributes: size of company & profitability; and audit related factors: audit opinion & the audit firm. Therefore, the research title is **“Do Company's Attributes and Audit Related Factors Affect Timeliness of Financial Reporting?”**



THEORETICAL FRAMEWORK AND HYPOTHESES DEVELOPMENT

Timeliness

Kieso et al, (2011) defines timeliness as an information should be informed as early as possible in order it can be used as the basis to help in decision making and have effect to the decision. Accounting professions and regulatory bodies has recognized timeliness as a goodness and positive content of financial reporting. It is suggested that the information that has been presented in a structured way should be value-relevance meets the particular choice criteria of users in timeliness of financial statements as stated by Izedonmi & Ibadin, (2012). Turel, (2010) stated that it has been contended that the shorter the time between the end of the accounting cycle and publication date indicates the more advantage that can be taken from the audited financial statements. But, it is impossible to publish yearly financial statements before it is audited by public accountant. According to Turel, (2010) timeliness could be defined as the difference number of day from the end of company's accounting cycle period with the day of the audit report.

Company Size & Timeliness

The size of company can be defined based on the total value of assets, total sales, market capitalization, and number of employment. The greater the value of these items then it can indicate the greater size of the company itself. The greater the assets owned by a company, it will lead to the more capital invested. The more sales company made, it will lead to the more rotation of money can be made. Further, the bigger the market capitalization of a company will lead the company to be more noticeable in the public as stated by Hilmi & Ali, (2008).

In the research of Turel (2010) and Alkhatib & Marji (2012) found that the company's size has negative but statistically not significant affection towards timeliness. There are reasons behind the relationship between size of company and timeliness. First, larger company will usually have more resources and better internal control which result in more timely reports and that logically the auditor is able to do the audit of large number transactions or activities easier and spend lesser time to maximize the timeliness. Next, the



larger the company, then the more noted they are in the public where usually financial analyst will ask the financial report faster in order to get information for the company's future prospect stated by Iyoha, (2012). Other study by Primantari (2016) finds that the higher assets owned, then a company tend to be slower in submitting and publishing their financial statement because the audit process took longer time.

Size of Company is expected to have a negative influence towards Timeliness of Financial Reporting. Since larger company is supposed to have more resources and better internal control which result in more timely report and is able to hire reputable audit firm which may result in a timelier of financial reporting. Therefore, following hypothesis is constructed:

H₁: Size of Company has negative influence towards Timeliness of Financial Reporting

Profitability & Timeliness

Profitability is one of the indicator to measure the success of the company in generating earnings. Therefore, the higher the profitability can indicate the higher the company's ability to generate profits for the company stated by Hilmi & Ali, (2008). According to Weygandt, Kimmel, & Kieso, (2013) Profitability is defined as a financial ratio that usually used by analyst as a tool to measure the effectiveness of management in doing their operations.

Research done by Iyoha (2012) find negative significant association between profitability of company and timeliness of financial reporting. The result from Turel (2010), that investigates profitability find that companies which are having loss tend to take longer time while companies which are having profit tend to be timely. Another result from Primantari, (2016) find positively significant correlation between profitability and timeliness of financial reporting where company which are having higher profitability ratio, tend to be more timely. However, Ibadin, Izedonmi, & Ibadin (2012) find insignificant association between profitability and timeliness.

Profitability is expected to have a negative influence towards Timeliness of Financial Reporting. Profitability shows the performance of management on how they manage the company's assets to generate income. According to signaling theory, company will not delay



any good news to be announced and profit is considered as a good news for company. Agency theory also indicates that, managements might get several benefits when they have good performance which logically they would announce good news as soon as possible. Therefore, the constructed hypothesis is:

H₂: Profitability has negative influence towards Timeliness of Financial Reporting

Audit Opinion & Timeliness

The quality of financial reporting could be achieved with the role of public accountant. The existence of public accountant is important since the assurance regarding the fairness of the financial statements are provided by them through their opinion in Hilmi & Ali, (2008). The opinion usually will be useful for the users of financial statements especially for investor who might had interest to invest their money to the company. There are four kinds of opinion that can be given by the auditor, namely: unqualified, qualified, disclaimer and adverse. Unqualified opinion will be given as it reflects the financial statements are assured to be free from material misstatements and accordance with the regulations.

A study conducted by Turel (2010) shows that companies that has qualified opinion tend to suffer from untimely in their financial statements compared to companies having a standard or unqualified opinion. Audit Opinion is expected to have a negative influence towards Timeliness of Financial Reporting. This is because when the company granted an opinion which is not standards, there might be further testing and or discussion will be done by the auditor to ensure the opinion is right which will consume more time compared to those who entitled with standard opinion. Based on signaling theory, standard opinion could be assumed as a good news where companies tend to announce faster. Therefore the constructed hypothesis is:

H₃: Audit Opinion gives negative influence to Timeliness of Financial Reporting

Audit Firm & Timeliness

Companies were asked to use the service of public accounting firm in order to present a report or information that is accurate and reliable to the public. In order to enhance the credibility of the report, the company will use the services of the firm that has a reputation or



good name. The big four accounting firm are usually chosen by company as they have an affiliation with the well-known accounting firm worldwide as shown in Hilmi & Ali, (2008). According to Turel, (2010) the lead time taken for the Big 4 public accounting firms will be fewer compared with the smaller public accounting firms.

Study done by Turel, (2010) found a positive correlation between audit firm size and timeliness of financial reporting. Meanwhile, AL-Taht, (2015) and Alkhatib et al. (2012) found no statistical evidence where audit firm give significant influence towards timeliness of financial reporting. On the other hand, the result from Iyoha, (2012), Primantari, (2016) and Ibadin et al, (2012) found negative and significant relationship between audit firm size and timeliness of financial reporting where the larger audit firm tend to be timelier in term of financial reporting. Ibadin et al, (2012) argued that larger accounting firm tend to be timely because they are large firms, in terms of partners, audit personnel, facilities and international affiliations so it makes it possible that the audit process done more efficiently and accurately.

Therefore, audit Firm is expected to have a negative influence towards Timeliness of Financial Reporting. The larger accounting firms then the more reputable they are and they need to maintain this reputation. Larger accounting firms also will have sufficient resources in term of audit personnel and facilities where logically the audit process could be done faster. Therefore, the following hypothesis is constructed:

H₄: Audit Firm has negative influence towards Timeliness of Financial Reporting

RESEARCH DESIGN

Empirical Design

This research aims to examine the influence of Company's Attributes (Size of Company and Profitability) and Audit Related Factors (Audit Opinion and Audit Firm) toward Timeliness of Financial Reporting

Below is the research model we use in this study:



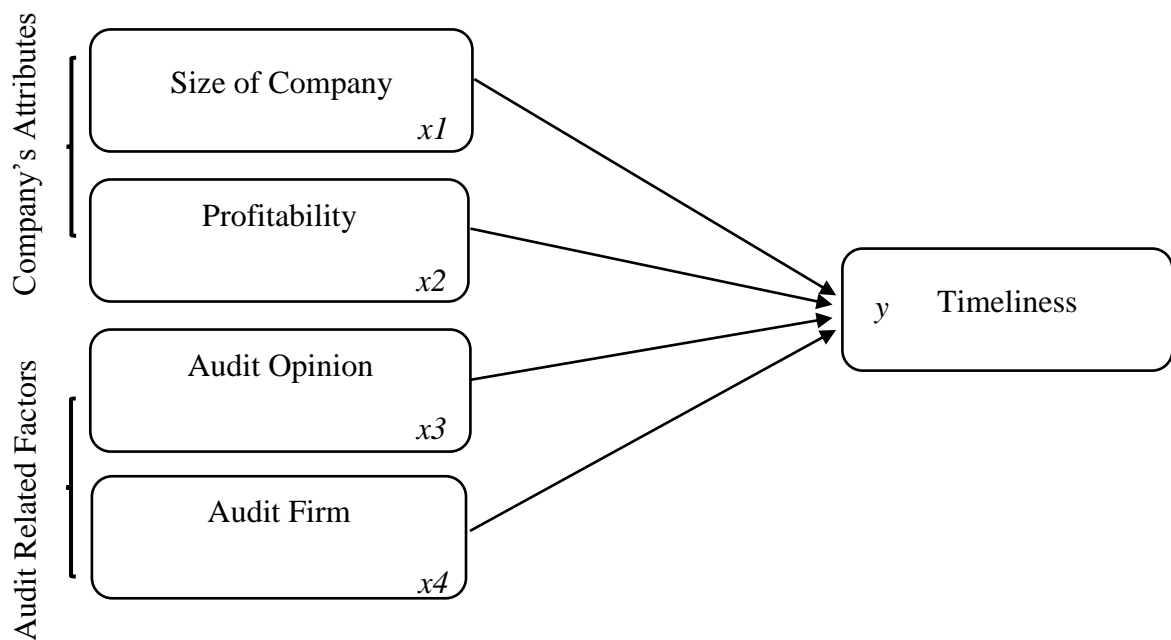

Figure 1

Timeliness

According to Turel, (2010) timeliness is defined as the difference number of day from the end of company's accounting cycle period with the day of the audit report.

Company Size

Size of company is one of the most used variable in determining timeliness and most of the researcher measure this variable with company's year-end total assets as the research done by Khasharmeh & Aljifri, (2010) and Alkhatib & Marji, (2012). In this research, natural log is used to minimize data variations.

Profitability

In this research, profitability is measured by return on asset since this ratio will measure the efficiency of the company on how they manage its assets and use them to generate their income. Return on assets can be calculated using the following formula:

$$\text{Return on Asset} = \frac{\text{Net Income After Tax}}{\text{Total Assets}}$$

Audit Opinion

Following the previous research done by Turel (2010), audit opinion is measured by dummy variable which identifies the type of opinion of companies. The code for measurement of this variables is 0 and 1. The value is given 0 if the opinion is categorized as a non-standard opinion. Meanwhile, the value is given 1 as if the opinion is categorized as standard opinion. A standard opinion is when a company had unqualified opinion and there is no others notes describes uncertainty of the company. Other than that, it assumed as a non-standard opinion.

Audit Firm

Audit firm variable is measured by using dummy variable which identifies the audit firm who audited the company as the previous research done by Turel, (2010). The value is given 0 if it is audited by non-big four accounting firm and otherwise coded 1 if it is audited by big four accounting firm.

Hypothesis Testing

This research aims are to find empirical evidence of the influence of Company Attributes (Size of Company & Profitability) and Audit Related Factors (Audit Opinion and Audit Firm) toward Timeliness of Financial Reporting. To achieve that, we perform multiple regression analysis method to examine the hypotheses and use the help of EVIEWS 9.0.

Therefore, the equation model using multiple linear regressions with for this research is as follow :

$$\text{TIME} = \beta_0 + \beta_1.\text{SIZE} + \beta_2.\text{PROFIT} + \beta_3.\text{AO} + \beta_4.\text{AF} + e \quad (1)$$

Description:

TIME : Timeliness of Financial Statements

β_0 : Constants

$\beta_1, \beta_2, \beta_3, \beta_4$: Coefficient of Independent Variables



SIZE : Size of Company (*natural log of total assets*)
PROFIT : Profitability (*ROA*)
AO : Auditor Opinion
CPA : Audit Firm Size

Sample

The data that is gathered from Indonesia Stock Exchange (IDX)'s website (www.idx.co.id) and take the audited financial statements of each company listed there. The information in IDX website and in the audited financial statements are used to analyze the influences of independent variables toward the dependent variable in this study.

Data panel is used to measure the variable which combine time series and cross sectional data. The time series data that will be used is 4 years started from 2012 until 2015. While, the cross sectional data is the number of companies mixed sector. Therefore, this research will observe and analyze data in total of 80 companies and it is equal to 320 data in total.

RESULTS

Descriptive Analysis

Timeliness of Financial Reporting

Data showed that during the period 2012 until 2015 variable timeliness of financial reporting 11 days minimum value and maximum value of 181 days. Meanwhile, the average level of timeliness in the year of 2012 until 2015 was 74.53750 or 75 days which 15 days before the due date. The median value was 79 and the standard deviation was 20.84707. The level of timeliness with a minimum value of 11 days was present in Bank QNB Indonesia Tbk in 2015. While, the maximum value of 181 days was present in Indo Straits Tbk in 2015.



Company Size

Variable size of company was calculated using the natural log of total assets companies at every year ended. The result from the data showed that in the period of 2012 until 2015 variable size of company has maximum value of 33.86267 (Rp. 508.595.288.000.000) and a minimum value of 23.80179 (Rp. 21.726.271.297). The average level of size of company shows 28.58048 (Rp. 17.754.650.766.114). The median value was 28.42324 and with standard deviation value of 1.874176. Company with the highest assets was Bank Negara Indonesia Tbk in 2015. While the lowest assets was Zebra Nusantara Tbk in 2015.

Profitability

Data showed that during 2012 until 2015 variable profitability had a maximum value of 0.457885 and the minimum value of -0.384391. The average level of profitability during 2012 until 2015 was 0.038814. Profitability variable had median value of 0.031577 and 0.089363 of standard deviation. Company that had the maximum value of profitability was Matahari Department Store Tbk in 2015. While, the minimum value of -0.384391 was present in Zebra Nusantara Tbk in 2015.

Audit Opinion

Audit opinion variable was measured by using dummy variable which identified the type of opinion of companies where the value was given 1 if the opinion is categorized as a standard opinion (unqualified opinion and no uncertainty about the company) and given 0 as if the opinion is categorized as non-standard opinion (other than standard opinion). Based on the data, during the observation periods there were 21 companies that received other than standard opinion and with the average of 99.9 days (100 days) in their timeliness. Meanwhile, there were 299 companies received the standard report during 2012-2015 with the average timeliness in 72.7 days (73 days).



Audit Firm

Audit firm variable was measured by using dummy variable which identifies the audit firm of the company. The value is given 0 if it was audited by non-big four accounting firm and given 1 if it is big four accounting firm. Based on the table descriptive analysis, during 2012-2015 there were 202 companies audited by non-big 4 audit firm and with the average timeliness in 78.9 days (79 days). While, there were 118 companies audited by big 4 audit firm and their average on timeliness is 66.9 days (67 days).

DISCUSSION

Company Size and Timeliness

From the result of t-Test, it indicated that size of company gave negative and insignificant statistical influence on timeliness of financial reporting. The β value showed -3.848427 which gives negative result on size of company towards timeliness of financial reporting. This means that every increases of 1 unit in company's size would impact to the shorter of timeliness of financial reporting.

However, the probability value shows 0.1377 which proves that size of company in partial and statistical did not have significant influence towards timeliness of financial reporting. This could be concluded that H_1 was rejected even there was negative impact of size of company towards timeliness of financial reporting since statistically did not gives evidence that size of company affect timeliness of financial reporting.

The result indicated that timeliness of financial reporting was not affected by the size of company. Large and small company might submit their financial report in a short time. This could be happened because larger companies might have higher resources, good internal controls and have the ability to acquire higher audit quality. However, smaller companies could also finish their audit in a short time because they have simpler and not too complex activities than larger companies which result in a timelier in financial reporting. In the study of Primantari (2016) who used company size as control variable and found significant effect, where large company will have slower timeliness in financial reporting and means that the result is contradicted with this research. However, this research result was consistent with the



findings of Turel, (2010), AL-Tahat, (2015), Khasharmeh & Aljifri, (2010), Iyoha, (2012), Ibadin et al, (2012) and Alkhatib & Marji, (2012) who found no empirical evidence that Size of Company influence Timeliness of Financial Reporting.

Profitability and Timeliness

The t-Test result indicated that profitability gave negative and significant influence towards timeliness of financial reporting. The β value was -61.46972 which showed a negative result on profitability towards timeliness of financial reporting. If other independent variables remain constant, means that every increase of 1% profitability will impact to the shorter time in financial reporting.

The probability value is 0.0000 which proved that profitability in partial and statistical has negative significant influence towards timeliness of financial reporting. Therefore, hypothesis 2 in this research was accepted.

The results showed that companies who were having profit would tend to be timelier in reporting their financial statements compared to those that suffer from loss. Referring to signaling theory, it could be said that profit was a good news for companies and companies would tend to report earlier since it might attract to the investor to keep investing to the company and also to the potential investor. The result was consistent with AL-Tahat, (2015), Khasharmeh & Aljifri, (2010), Primantari, (2016) and Turel, (2010) who found profitability gave significant and negative impact towards timeliness of financial reporting.

Audit Opinion and Timeliness

From the result of t-Test, it showed that audit opinion gave negative and significant influence towards timeliness of financial reporting. The β value is -18.24159 which showed negative result on audit opinion towards timeliness of financial reporting. Dummy variable was used to measure audit opinion where 1 represented standard opinion (unqualified opinion and no uncertainty in company's business) and 0 represented non-standard opinion (other than unqualified). Meanings that if a company was entitled with standard opinion or that could be said company with unqualified opinion would result in a timelier of financial reporting.



The probability of 0.0235 which was lower than the significant level of 0.05 proved that audit opinion in partial and statistical gave negative significant impacted to timeliness of financial reporting. Therefore, hypothesis 3 of this research was accepted.

The result showed empirical evidence that company with standard opinion tend to be timelier in financial reporting. This could be happened because the audit process of standard opinion tended to be faster compared to those with non-standard opinion. Since, non-standard opinion could result in further testing and discussion that need to be done to ensure the qualification for non-standard opinion given is favorable. This result was consistent with the research done by Turel, (2010), Primantari, (2016) and Khasharmeh & Aljifri, (2010).

Audit Firm and Timeliness

The t-Test result showed that audit firm gave positive and significant influence towards timeliness of financial reporting. The β value was 23.19786 which showed positive result on timeliness of financial reporting. Dummy variable was used to measure audit firm where 1 represented the company audited by big four audit firm and 0 represented the company audited by non-big four audit firm. The positive result indicated that companies audited by non-big four audit firm would increase their timeliness of financial reporting compared to non-big four audit firm.

The probability score was 0.0018 which proved that audit firm influenced timeliness of financial reporting with positive and statistically significant. Then it can be concluded that hypothesis 4 in this research is rejected.

The result showed empirical evidence that companies audited by big four audit firm tended to be slower in timeliness of financial reporting and contradicted with the hypothesis proposed in the research. This situation might be happened because since big four audit firms has high reputation, it could be said that many companies with higher complexity tend to use their services other than smaller audit firms in order to get better audit quality. Logically, the more complex a company was, then the longer audit process might be occurred and finally it would affect in slowing down the timeliness of financial reporting. The result was contradicted with Ibadin, Izedonmi, & Ibadin, (2012) that found audit firm has negative and significant influence towards timeliness of financial reporting. However, it is accordance with



Turel, (2010) and Khasharmeh & Aljifri, (2010) which prove positive and significant influence of audit firm towards timeliness of financial reporting.

CONCLUSION & IMPLICATION

Size of Company gave partially negative but not significant statistically influencing Timeliness of Financial Reporting where hypothesis 1 of this research was rejected. This result showed that both larger and smaller companies were able to report their audited financial statements in a timely manner or in other words, timeliness of financial reporting is not affected by the size of company.

Profitability and Audit Opinion gave partially negative and statistically significant influence towards Timeliness of Financial Reporting where hypothesis 2 and 3 of this research were accepted and in accordance with the logic behind thus hypothesis. According to the results, company that suffered from loss and or have a non-standard opinion would tend to be slower in reporting their audited financial statements.

Audit Firm gave partially positive and statistically significant influence towards Timeliness of Financial Reporting where hypothesis 4 of this research was rejected. It implied that from the result, companies audited by big four accounting firms tended to be the late reporter. This could happen because company with higher complexity often use the services from big four accounting firm to achieve high audit quality and in doing the audit of a more complex business, it would consume more time to finish the audit processes.

All independent variables (Size of Company, Profitability, Audit Opinion and Audit Firm) simultaneously significant statistically in influencing dependent variable (Timeliness of Financial Reporting).

REFERENCES

- Al-Ghanem, W., & Hegazy, M. (2011). An empirical analysis of audit delays and timeliness of corporate financial reporting in Kuwait, Eurasian. *Eurasian Business Review Volume 1*, 73-90.
- Alkhatib, K., & Marji, Q. (2012). Audit reports timeliness: Empirical evidence from Jordan. *Procedia - Social and Behavioral Sciences Volume 62*, 1342-1349.



- AL-Tahat, S. S. (2015). Company Attributes and the Timeliness of Interim Financial Reporting In Jordan. *International Journal of Application or Innovation in Engineering & Management (IJAIEEM)*, 6-16.
- Ghozali, I., & Ratmono, D. (2013). *Analisis Multivariat Dan Ekonometrika*. Semarang: Badan Penerbit Universitas Diponegoro.
- Godfrey et al, J. (2010). *Accounting Theory 7th edition*. Australia: John Wiley & Sons Australia, Ltd.
- Gujarati, D. N. (2004). *Basic Econometrics 4th Economy Edition*. Tata McGraw Hill.
- Hair, J. F., Black, B., Babin, B., Anderson, R. E., & Tatham, R. L. (2006). *Multivariate Data Analysis*. New Jersey: Pearson.
- Hashim, U. J., & Rahman, R. B. (2010). Board independence, board diligence, board expertise and impact on audit report lag in Malaysian market. *Finance and Corporate Governance Conference 2011 Paper*.
- Hilmi, U., & Ali, S. (2008). Analisis Faktor-Faktor yang Mempengaruhi Ketepatan Waktu Penyampaian Laporan Keuangan. *Jurnal dan Prosiding SNA - Simposium Nasional Akuntansi XI*, 1-26.
- IAI. (2012). *Standar Akuntansi Keuangan*. Jakarta: IAI.
- Ibadin, I. M., Izedonmi, F., & Ibadin, P. O. (2012). The Association Between Selected Corporate Governance Attributes, Company Attributes And Timeliness Of Financial Reporting In Nigeria. *Research Journal of Finance and Accounting*, 137-145.
- Indonesia Stock Exchange. *PT. Bursa Efek Indonesia*. (www.idx.co.id).
- Iyoha, F. (2012). Company Attributes and The Timeliness of Financial Reporting in Nigeria. *Business intelligence journal*, 41-49.
- Izedonmi, F., & Ibadin, P. O. (2012). Audit Delay Determinants in Quoted Companies: Empirical Evidence from Nigeria. *The Pakistan Journal of Social Issues*, 161-176.
- Khasharmeh, H. A., & Aljifri, K. (2010). The timeliness of annual reports in Bahrain and the United Arab Emirates: an empirical comparative study. *The International Journal of Business and Finance Research*, Vol. 4, No. 1, 51-71.
- Kieso, D. E., Weygandt, J. J., & Warfield, T. D. (2011). *Intermediate Accounting 14th edition*. John Wiley & Sons.



- Peraturan Bapepam no X.K.2 nomor KEP-346/BL/2011 tentang Penyampaian Laporan Keuangan Berkala Emiten atau Perusahaan Publik (www.ojk.go.id).
- Primantari, S. T. (2016). Pengaruh Corporate Governance, Profitabilitas, dan Kualitas Audit Terhadap Ketepatanwaktuan Laporan Keuangan.
- Sarwono, J. (2016). *Prosedur - Prosedur Analisis Populer Aplikasi Riset Skripsi Dan Tesis Dengan Eviews*. Gava Media.
- Sekaran, U., & Bougie, R. (2013). *Research Method for Business*. Wiley.
- Sriyana, J. (2014). *Metode Regresi Data Panel*. Yogyakarta: Ekonisia.
- Turel, A. (2010). Timeliness of financial reporting in emerging capital markets: Evidence From Turkey. *Istanbul University Journal of the School of Business Administration Vol. 39 Issue 2*, 227-240.
- Weygandt, J. J., Kimmel, P. D., & Kieso, D. E. (2013). *Financial Accounting IFRS Edition*. John Wiley & Sons, Inc.

Table Summary of Sample

(a) Industry Type	(b) Amount	(c) Population in %	(d) Sample Number (b*19.56%)
Financial	68	17%	13
Agriculture	16	4%	3
Manufacture	117	29%	23
Property	50	12%	10
Mining	34	8%	7
Service	36	9%	7
TSI	88	22%	17
Total	<u>409</u>	100%	<u>80</u>

Table Descriptive Statistics (1)

	TIME	SIZE	PROFIT
Mean	74.53750	28.58048	0.038814
Median	79.00000	28.42324	0.031577
Maximum	181.0000	33.86267	0.457885
Minimum	11.00000	23.80179	-0.384391
Std. Dev.	20.84707	1.874176	0.089363

Table Descriptive Statistics (2)

Indicator	Mean	Max	Min	Observation	Percentage
Audit Opinion					
0	99.67	181	59	21	7%
1	72.77	147	11	299	93%
All	74.54	181	11	320	100%
Audit Firm					
0	78.99	151	30	202	63%
1	66.92	181	11	118	37%
All	74.54	181	11	320	100%

Table Multiple Regression Analysis Results

Variable	Coefficient
C	195.4036
SIZE	-3.84843
PROFIT	-61.4697
AO	-18.2416
AF	23.19786

Table Coefficient of Determination (Adjusted R²) Result

Indicator	Value
Adjusted R-squared	0.661523

Table Simultaneous Test (F-Test) Result

Indicator	Value
Prob (F-Statistic)	0.0000

Table Partial Test (t-Test) Result

Variable	Coefficient	Probability Value	Result	Hypothesis
SIZE	-3.84843	0.1377	Negative Insignificant	Not Supported
PROFIT	-61.4697	0.0000	Negative Significant	Supported
AO	-18.2416	0.0235	Negative Significant	Supported
AF	23.19786	0.0018	Positive Significant	Not Supported

**EARNINGS BENCHMARKS AND TIMELINESS OF AUDIT REPORTS:
CORPORATE GOVERNANCE MECHANISM AS MODERATING VARIABLE**

Antonius Herusetya

Accounting Program Study, Faculty of Economics, Universitas Pelita Harapan
antonius.herusetya@uph.edu

Abstract

This study examines the relationship the tendency of management to meet earnings targets (earnings benchmarks) and the timeliness of audit reports. The timeliness of audit reports is measured by the number of days from the date of fiscal year-end of the financial statements until the date of the audit report. While the tendency to meet the earnings target is measured using a tendency to report a slight of net income and little change in earnings compared with previous year. This study also examines the role of corporate governance mechanisms through the role of board of directors and audit committees in relation to earnings management's tendency to meet earnings targets and the timeliness of audit reports. Using 419 firm-years observation of manufacturing companies listed in Indonesia Stock Exchange (IDX) during the period of 2009-2014, as well as using multiple regression, these studies did not find evidence that earnings management using a tendency to meet earnings targets affect the timeliness of audit report. However, by using 300 firm-years observation from manufacturing industry listed on IDX for the year 2010-2014, I found weak evidence that corporate governance mechanism through the role of board of commissioners and audit committee have a moderating role that weaken the positive relationship between the tendency to meet earnings targets with the timeliness of the audit report.

Keywords: *earnings benchmarks, audit report timeliness, corporate governance, board of commissioner, audit committee*

JEL Classification: *M42*



INTRODUCTION

Past researches have documented that change in environment of financial statements and audit lead to a longer or reduced number of days in audit time (Whitworth & Lambert, 2014; Mitra et al., 2015; Pizinni et al., 2015; OJK, 2014). The number of days required to complete audited financial statements, i.e., audit delay will increase significantly with the implementation Section 404 of the SOX Act in 2002 (Pizinni et al., 2015; Ettredge et al., 2006). On the other hands, the presence of high quality internal audit section, as well as the implementation of Auditing Standard No. 5 for public listed companies introduced by the Public Company Accounting Oversight Board (PCAOB) in 2007, researchers found that the audit process become more efficient and more timely, and reduces the audit report lag (Pizinni et al., 2015; Mitra et al, 2015). Other researchers found evidence that audit quality as measured by office-specific industry expertise negatively associated with audit delay, while the higher interests on client positively associated with audit delay (Whitworth & Lambert, 2014). With the increase in audit report lag, others also found evidence the increased restatement of audited financial statements (Blankley et al., 2015).

Longer days in the timeliness of audit report is suspected to lead less relevant information to the capital market, and thus give indications of red flags and lower earnings quality (Blankley et al., 2015; 2014). This low earnings quality can be caused partly by the problem of earnings management, restatement of financial statements, and deficiency of internal control (e.g., Dechow et al., 2010; Dechow and Schrand, 2004).

Previous researchers also found that there is a tendency for managers to manage earnings to meet earnings targets (Graham et al., 2005; Brown & Caylor, 2005; Burgstahler & Dichev, 1997). Managers might engage in earnings management by focusing to achieve earnings target by avoiding to report loss or little change in income compared with the previous year (Graham et al., 2005) thus reflect bad business decisions (Burgstahler & Dichev, 1997). External auditors then need a longer time in audit process and in detecting earnings management conducted by the management that affect the timeliness of audit reports (Ettredge et al., 2006; Blankley et al., 2015; 2014). Ettredge et al., (2006) for example, found that the material weakness in internal control over financial reporting associated with longer



audit delay. Our study investigate the association between the tendency to meet earnings benchmarks as a tool of earnings management and the timeliness of audit report.

Board of commissioners and audit committee as an institution that runs the mechanisms of corporate governance have role in controlling the financial reporting process and the audit of it so as to reduce the audit delay (Nor et al., 2010; Caramanis & Lennox, 2008). Our study investigate the moderating role of board of commissioners and audit committee in the association between the tendency of management to meet earnings benchmarks and the timeliness of audit report.

LITERATURE REVIEW AND HYPOTHESIS DEVELOPMENT

The Tendency to Meet Earnings Target and Audit Report Timeliness

The achievement of earnings targets used as indicators to evaluate the performance of the entity for public listed companies, thereby reducing the cost of processing information (Graham et al., 2005). And investors prefer to invest in companies that meet or exceed the target as a reference point, so as to give a higher valuation, whichever is the company has a better performance compared to other companies (Kahnerman & Tversky, 1979).

Results of previous studies documented their increasing tendency that the management of public companies manage earnings to meet earnings targets (e.g., Graham et al., 2005; Rees, 2005). Motivation to meet earnings targets indicates that the earnings quality is low (Dechow and Schrand, 2004; Cohen & Zarowin, 2010). This indicates also that there is a problem in their internal control, i.e., for example the issues of management integrity as a part of the control environment (Arens et al., 2015).

Therefore, auditors are dealing with internal control in audit of financial statements, and auditors are likely to have longer audit time in a company problematic internal controls (e.g., Caramanis & Lennox, 2008; Brankley et al., 2014; 2015). We conclude that a tendency to meet earnings target is expected to increase audit report lag. Thus our hypothesis to be tested is formulated as follows:

H1: The tendency to meet earnings targets positively effects audit report lag.



Corporate Governance Mechanism, Earnings Benchmarks, and Audit Report Timeliness

Prior studies have documented the relationship of corporate governance with financial statement information (Bushman & Smith, 2001). Several studies have examined the association where the audit committee with the quality of financial statements (e.g., Beasley, 1996; DeFond & Jiambalvo, 1991). Other studies examined the activities and mechanisms of corporate governance with the quality of financial statements (e.g., Xie et al., 2003).

Corporate governance mechanisms have a function in the supervision of internal financial reports and can improve the quality of earnings. Studies in Indonesia, Hermawan (2011) for example, found that if the board of commissioners carry out their functions effectively, the earning response coefficients will be higher. This indicates that the earnings quality is increasingly high. Corporate governance mechanisms through the function of the board of commissioners and audit committee can help the process of monitoring the financial reporting independently, and further enhance the quality of financial reporting, and thus reduce the work of the external auditor and audit report lag.

Based on these reasons, our hypotheses to be tested in this study was formulated as follows:

H2: Corporate governance mechanism through board of commissioners and audit committee weakens (strengthen) the positive (negative) association between earnings benchmarks and audit report lag.

RESEARCH DESIGN

Sample Selection and Data Sources

Population in this study are listed companies in manufacturing industry in Indonesia Stock Exchange (BEI). We used purposive sample selection method with a criteria as follows: (i) The sample are companies listed in the Indonesia Stock Exchange with the observation period of 2009-2014; and (ii) The companies have audited financial statements with the fiscal period ended on December 31, and complete annual report.



This study uses secondary data of the financial data derived from the company's financial statements published by the Indonesia Stock Exchange (IDX), as well as on the company home page or BEI. Non-financial data source for audit committee and board of commissioners are from the annual report for the calculation of scores Board of Commissioners and the Audit Committee.

Empirical Model and Measurement of Variables

Empirical Model to test the hypothesis H1

We use two empirical model to test hypothesis H1 as follows:

$$ARL_{it} = \alpha_0 + \alpha_1 MBE_{it} + \alpha_2 BIG4_{it} + \alpha_3 OPINI_{it} + \alpha_4 ROA_{it} + \alpha_5 LEV_{it} + \alpha_6 SIZE_{it} + e_{it} \dots\dots\dots \text{Model 1}$$

$$ARL_{it} = \beta_0 + \beta_1 DMBE_{it} + \beta_2 BIG4_{it} + \beta_3 OPINI_{it} + \beta_4 ROA_{it} + \beta_5 LEV_{it} + \beta_6 SIZE_{it} + e_{it} \dots\dots\dots \text{Model 2}$$

The main variable in Model 1 is MBE (Small Earnings Level) that measures the tendency to meet earnings targets, i.e., a small earnings target. Coefficient α_1 is predicted positive and significant, indicating that the tendency to meet or slightly exceed its earnings target will positively influence audit report lag (ARL). MBE is a dummy variable (1; 0), following Yulianti (2004) and Frankel et al. (2002), given 1 if net income scaled by total assets is in the interval of 0.00 and 0.02, and 0 if others. While ARL is the number of days from the date of the financial statements based on the fiscal year until the date of audit report (Blankley et al., 2015; Knechel & Payne, 2001).

While on Model 2, the main variable is DMBE (Small Earnings Increase), which is the tendency to meet earnings targets measured by a tendency to meet or exceed little changes in earnings compared with the previous year, and predicted coefficient DMBE (β_1) is positive and significant. DMBE is a dummy variable (1; 0), following Yulianti (2004) and Frankel et al. (2002), given 1, if the change in net income scaled by total assets is in the



interval of 0.00 to 0.01, and 0 if other. We use control variables in Model 1 and Model 2 i.e., BIG4, OPINION, ROA, LEV, SIZE based on the previous studies.

Empirical Model to test the hypothesis H2

We use two models to test hypothesis H2 as follows:

$$ARL_{it} = \delta_0 + \delta_1 MBE_{it} + \delta_2 DK_{it} + \delta_3 KA_{it} + \delta_4 MBE*DK_{it} + \delta_5 MBE*KA_{it} + \delta_6 BIG4_{it} + \delta_7 OPINI_{it} + \delta_8 ROA_{it} + \delta_9 LEV_{it} + \delta_{10} SIZE_{it} + e_{it} \dots\dots\dots \text{Model 3}$$

$$ARL_{it} = \lambda_0 + \lambda_1 DMBE_{it} + \lambda_2 DK_{it} + \lambda_3 KA_{it} + \lambda_4 DMBE*DK_{it} + \lambda_5 DMBE*KA_{it} + \lambda_6 BIG4_{it} + \lambda_7 OPINI_{it} + \lambda_8 ROA_{it} + \lambda_9 LEV_{it} + \lambda_{10} SIZE_{it} + e_{it} \dots\dots \text{Model 4}$$

In Model 3, our main variable is MBE*DK and MBE* KA with coefficient δ_4 and δ_5 is predicted negative and significant. This indicates that the Board of Commissioners and the Audit Committee to perform effectively in the internal control of financial reporting, giving the effect to weaken (strengthen) the positive (negative) tendency to meet earnings targets as measured by MBE.

In Model 4, the main variable is DMBE*DK and DMBE*KA, with coefficient λ_4 and λ_5 is predicted negative and significant. In Model 3 and Model 4 also included some control variables, because these variables did influence variable ARL directly as with previous empirical models.

Measurement of Board of Commissioners (DK) and Audit Committee (KA)

Our measurement of the effectiveness of the Board of Commissioners (DK) and the Audit Committee (KA) follow Hermawan (2011). She used content analysis using the criteria from the Indonesian Institute for Corporate Directorship (IICD). There are three possible assessment in each question in the lists both for DK and KA: Good, Fair and Poor. The value set for Good, Fair, and Poor is 3, 2, and 1 respectively. If the total score of DK equals and more than 34, we give the value of 1, and 0 for others. And if the total score of KA equal and more than 22, we give the value of 1, and 0 for other. Please see the computation for details in Hermawan (2011).



RESULTS AND DISCUSSION

Descriptive Statistics

Descriptive statistics for Model 1 and 3 in Table 1 shows the standard deviation is relatively small, except for the variable ARL, so it can be concluded that the distribution of the variables studied are homogeneous. Mean ARL indicates that the average completion time for is 79 days. MBE, as a measure of earnings management has mean of 0.19, indicating that the proportion of listed companies to meet earnings targets (MBE) is around 19 percent. Variable DK has mean of 34.17 indicates that the number of firm-years observation has a score that indicates the board of commissioners function relatively effective, because the threshold score is 34 or higher (Hermawan, 2011). Mean of KA is 25.05, above the threshold of 22 indicates that the audit committee from the observations function effectively.

Descriptive statistics for Model 2 and Model 4 is presented in Table 2 also shows the standard deviation is relatively small for 300 firm-years of observation. Mean of ARL is 79 days, with a minimum of 33 days and a maximum amount of 177 days. The mean of DK is 34.23, and mean score of the audit committee (KA) is also above the minimum threshold of 22, i.e., 24.91.

Hypothesis Testing Results

Hypothesis Testing Results H1

Hypothesis testing results of H1 contained in Tables 3 and 4, each of which is the result of testing the hypothesis H1 using Model 1 and Model 2. Results of hypothesis testing using Model 1 in Table 3 shows that the test specifications of the model as a whole have low R-squared 3.94 percent, but significant at the 0.01 level (F-test = 5.35). MBE coefficient is not significant at 0.10 ($\alpha_1 = 1.21$, t-test = 0.52). These test results have not found evidence that the tendency to meet earnings targets by reporting a small earnings (MBE) is not associated with the length of time reporting of audits conducted by auditors.



Table 1. Descriptive Statistics of Variables - Model 1 and Model 3

Variable	Obs	Mean	Std. Dev.	Min	Max
arl	419	78.68019	17.54251	31	177
mbe	419	.1861575	.389699	0	1
dk	419	34.16706	3.677263	26	43
ka	419	25.04773	4.555623	11	32
big4	419	.3627685	.4813736	0	1
opini	419	.928401	.2581311	0	1
roa	419	.0749936	.1433222	-.7753	.8617
lev	419	.5256138	.3597631	0	1.9494
size	419	27.85609	1.740151	19.7793	35.3976

Table 2. Descriptive Statistics of Variables - Model 2 and Model 4

Variable	Obs	Mean	Std. Dev.	Min	Max
arl	300	78.55667	16.94927	33	177
dmbe	300	.1933333	.3955719	0	1
dk	300	34.23	3.580479	26	43
ka	300	24.91333	4.587225	11	32
big4	300	.36	.480802	0	1
opini	300	.93	.2555733	0	1
roa	300	.0674613	.1433573	-.7753	.6701
lev	300	.4839927	.2714795	0	1.8652
size	300	27.89382	1.821189	19.7793	35.3976

Results of hypothesis testing H1 in Model 2 using the tendency to meet earnings targets measured by reporting little changes in earnings (DMBE) can be seen in Table 4. Model 2 has R-squared 3.36 percent with F-test 3.63, significant at 0.01 level. The main variables DMBE has a coefficient $\beta_2 = 2,896$, not significant at 0.10 against the ARL, consistent with the results from Model 1. In other words, we found no evidence that the tendency to report little change in net income (DMBE) have any association with the length of time the audit (ARL). In summary, the testing results of hypothesis H1 using Model 1 and 2 showed no evidence that earnings management tools using earnings benchmarks either by reporting a small profit, and little change in profit have no association with the length of audit time. Thus the hypothesis H1 is rejected.

Table 3. Testing Result of Hypothesis H1 – Model 1

Linear regression	Number of obs = 419
	F(6, 412) = 5.35
	Prob > F = 0.0000
	R-squared = 0.0394
	Root MSE = 17.318

		Coef.	Robust Std. Err.	t	P> t	[95% Conf. Interval]	
arl							
mbe		1.209666	2.348508	0.52	0.607	-3.406887	5.826218
big4		-1.304337	2.209657	-0.59	0.555	-5.647946	3.039271
opini		-3.044223	2.792512	-1.09	0.276	-8.533572	2.445125
roa		-11.66365	4.999367	-2.33	0.020	-21.4911	-1.836199
lev		4.654872	2.250449	2.07	0.039	.2310766	9.078667
lnta		-.1771328	.5704912	-0.31	0.756	-1.298569	.9443038
_cons		85.11669	15.77088	5.40	0.000	54.11527	116.1181

Source: Output from Stata Software

Table 4. Testing Result of Hypothesis H1 – Model 2

Linear regression	Number of obs = 300
	F(6, 293) = 3.63
	Prob > F = 0.0017
	R-squared = 0.0376
	Root MSE = 16.797

		Coef.	Robust Std. Err.	t	P> t	[95% Conf. Interval]	
arl							
dmbe		2.896245	2.913628	0.99	0.321	-2.838048	8.630538
big4		-.6796036	2.778836	-0.24	0.807	-6.148612	4.789405
opini		-4.308813	2.572249	-1.68	0.095	-9.37124	.7536134
roa		-9.548456	5.639877	-1.69	0.092	-20.64826	1.551349
lev		4.576185	2.885615	1.59	0.114	-1.102975	10.25535
lnta		-.3990594	.6473169	-0.62	0.538	-1.673039	.8749207
_cons		91.80918	17.0491	5.38	0.000	58.25495	125.3634

Source: Output from Stata Software

Hypothesis Testing Results H2

The test results on the hypothesis H2 are shown in Table 5 using Model 3, and Table 6 using Model 4. The test results in Model 3 shows that the model specification test results as a whole have R-squared of 4.84 percent and F-test 3.73, significant at 0.01 level. The main variables in this test, both MBE*DK and MBE*KA are not significant at the level of 0.10. This test shows no evidence that the effectiveness of the board of commissioners and audit committee effectiveness have any moderating role in their association between the tendency to meet earnings targets by reporting little profit (MBE) and the length of audit time.



Table 5. Testing Results of Hypothesis H2 – Model 3

Linear regression	Number of obs = 419
	F(10, 408) = 3.73
	Prob > F = 0.0001
	R-squared = 0.0484
	Root MSE = 17.321

arl	Coef.	Robust Std. Err.	t	P> t	[95% Conf. Interval]	
mbe	.588649	14.70446	0.04	0.968	-28.31732	29.49462
dk	-.3843974	.3199517	-1.20	0.230	-1.013357	.2445622
ka	-.0371064	.207575	-0.18	0.858	-.4451563	.3709435
mbexdk	-.3578355	.501399	-0.71	0.476	-1.343483	.6278124
mbexka	.5192951	.4479487	1.16	0.247	-.3612803	1.399871
big4	-1.207109	2.385879	-0.51	0.613	-5.897259	3.483041
opini	-3.968105	2.768356	-1.43	0.153	-9.410127	1.473917
roa	-10.25272	4.845855	-2.12	0.035	-19.77868	-.7267628
lev	3.641524	2.437361	1.49	0.136	-1.149829	8.432876
size	.1188805	.5345135	0.22	0.824	-.9318636	1.169625
_cons	92.29898	19.5545	4.72	0.000	53.85883	130.7391

Source: Output from Stata Software

Table 6. Testing Results of Hypothesis H2 – Model 4

Linear regression	Number of obs = 300
	F(10, 289) = 4.51
	Prob > F = 0.0000
	R-squared = 0.1180
	Root MSE = 16.191

arl	Coef.	Robust Std. Err.	t	P> t	[95% Conf. Interval]	
dmb	65.09352	15.41295	4.22	0.000	34.75766	95.42939
dk	-.1684417	.2673467	-0.63	0.529	-.6946352	.3577517
ka	.2542538	.2348197	1.08	0.280	-.2079199	.7164275
dmbexdk	-.0226641	.0612109	-0.37	0.711	-.1431398	.0978116
dmbexka	-2.532932	.6066871	-4.18	0.000	-3.727018	-1.338847
big4	-.3794609	2.934205	-0.13	0.897	-6.154582	5.39566
opini	-2.64739	2.785407	-0.95	0.343	-8.129646	2.834866
roa	-8.400742	5.55033	-1.51	0.131	-19.32494	2.523453
lev	1.708185	2.741044	0.62	0.534	-3.686755	7.103126
size	-.4346896	.6293146	-0.69	0.490	-1.673311	.8039315
_cons	79.86721	21.69293	3.68	0.000	37.17104	122.5634

Source: Output from Stata Software

The test results using interaction variables DMBE*DK and DMBE*KA using Model 4 are presented in Table 6. DMBE interaction variables, DMBE*DK and DMBE*KA indicates whether the board of commissioners and audit committee have a moderating role in



the relationship between the tendency to report a little change in reporting earnings (DMBE) and the length of audit time (ARL). The test results in Table 6 shows that the model specifications have R-squared of 11.80 percent with a value of 4.51 F-test, significant at the 0.01 level. DMBE variables are positive and significant at 0.01 level, while the variable DMBE*KA negative and significant at 0.01 level. While the interaction variables DMBE*DK is not significant at 0.10. The test results on the Model 4 indicates the role of the audit committee (KA) as a moderating variable that weaken the relationship between the tendency to report little change in reported earnings (DMBE) and the timeliness of audit report (ARL).

In conclusion, from the H2 hypothesis testing using Model 3 and Model 4, we found some evidence that the mechanism of corporate governance through audit committee could weaken the positive relationship between earnings management using earnings benchmarks and the timeliness of audit report. Thus the hypothesis H2 can be accepted.

CONCLUSIONS AND RECOMMENDATIONS

This study examines the association of earnings management through earnings benchmarks, either by reporting little earnings and reporting little changes in net income to the timeliness of the audit reports. This study also examines the role of the corporate governance mechanism through the role of board of commissioners and audit committee as moderating role in the association between the tendency to meet earnings targets and the timeliness of audit report.

By using the 419 firm-years observations from listed companies in the Indonesian Stock Exchange in the year 2009-2014 and using linear multiple regression, we found no evidence that earnings management through a tendency to meet earnings target has any associations with audit report lag or the timeliness of audit report. Furthermore, this study using 300 firm-years of data observation from 2010 to 2014, found some evidence that the corporate governance mechanisms using board of commissioners and audit committee have a moderating role that weaken the positive relationship between the tendency to meet earnings targets and the length of days of audit reports.



The study found only some evidence regarding the role of audit committees in the corporate governance mechanisms. Hermawan (2011) found that when the role of board of commissioners is weak, the role of the audit committee will be much more involved. Further study must consider what kind of significant audit committee roles that give more impact in the moderating role in this association. Further study must also consider other kind of earnings management tools that board of commissioners and audit committee can minimize this tools and behavior.

REFERENCES

- Arens, A.A, Elder, R.J., & Beasley, M.S. (2014), *Auditing and Assurance Services, an Integrated Approach*. Pearson, 15th edition, England.
- Beasley, M.S. (1996), “An Empirical Analysis of the Relation between the Board of Director Composition and Financial Statement Fraud”, *The Accounting Review*, 71, 4, 443-465.
- Blankley, A.I, Hurtt, D.N., MacGregor, J.E. (2015), “Are Length Audit Report Lags a Warning Signal?” *Current Issues in Auditing*, 9, 2, 19-28.
- Blankley, A.I, Hurtt, D.N., MacGregor, J.E. (2014), “The Relationship between Audit Report Lags and Future Restatements”, *Auditing: A Journal of Practice & Theory*, 33, 2, 27-57.
- Brown, L.D. & Caylor, M.L. (2005), “A Temporal Analysis of Quarterly Earnings Thresholds: Propensities and Valuation Consequences”, *The Accounting Review*, 80, 2, 423-440.
- Burgstahler, D. & Dichev, I. (1997), “Earnings Management to Avoid Earnings Decrease and losses”, *Journal of Accounting and Economics*, 24, 99-126.
- Bushman, R.M & Smith, A.J. (2001), “Financial Accounting Information and Corporate Governance”. *Journal of Accounting and Economics*, 32, 237-333.
- Caramanis, C. & Lennox, C. (2008), “Auditor Effort and Earnings Management”, *Journal of Accounting and Economics*, 45, 116-138.



- Cohen, D.A. & Zarowin, P. (2010), "Accrual-Based and Real Earning Management Activities around Seasoned Equity Offerings". *Journal of Accounting and Economics*, Article in press January 2010, doi:10.1016/j.jacceco.2010.01.002.
- Dechow, P.M. & Schrand, M.C. (2004), *Earnings Quality*, The Research Foundation for CFA Institute, USA.
- Defond, M.L & Jiambalvo, J. (1991), "Incidence and Circumstances of Accounting Errors", *The Accounting Review*, 66, 3, 643-656.
- Ettredge, M.L., Li, C., Sun, L. (2006), "The Impact of SOX Section 404 Internal Control Quality Assesment on Audit Delay in the SOX Era", *Auditing: A Journal of Practice & Theory*, 25, 2, 1-23.
- Frankel, R.M., Johnson, M.F. & Nelson, K.K. (2002), "The Relation between Auditors's Fee for Nonaudit Services and Earnings Management", *The Accounting Review*, 77, 71-105.
- Graham, J.R., Harvey, C.R. & Rajgopal, S. (2005), "The Economic Implications of Corporate Financial Reporting". *Journal of Accounting and Economics*, 40, 3-73.
- Hermawan, A. A. (2011), "The Influence of Effective Board of Commissioners and Audit Committee on the Informativeness of Earnings: Evidence from Indonesian Listed Firms", *Asia Pacific Journal of Accounting and Finance*, 2, 1, 1-38.
- Kahneman, D. & Tversky, A. (1979), "Prospect Theory: An Analysis of Decision under Risk", *Econometrica*, 47, 2, 263-291.
- Knechel, W.R. & Payne, J.L. (2001). "Additional Evidence on Audit Report Lag". *Auditing: A Journal of Practice & Theory*, 20, 1, 137-146.
- Mitra, S., Song, H. & Yang, J.S. (2015). "The Effect of Auditing Standard No. 5 on Audit Report Lag", *Accounting Horizon*, 29, 3, 507-527.
- Nor, M.N.M., Shafie, R. & Hussin, W.N.W. (2010), "Corporate Governance and Audit Report lag in Malaysia", *Asian Academy of Management Journal of Accounting and Finance*, 6, 2, 57-84.
- Otoritas Jasa Keuangan Indonesia, (2014), "Salinan Peraturan Otoritas Jasa Keuangan Nomor 33/POJK.04/2014 tentang Direksi dan Dewan Komisaris Emiten atau Perusahaan Publik".



- Pizinni, M., Lin, S., & Ziegenfuss, D.E. (2015). “The Impact of Internal Audit Quality and Contribution on Audit Delay”, *Auditing: A Journal of Practice & Theory*, 13, 1, 25-58.
- Rees, L. (2005), “Abnormal Returns from Predicting Earnings Thresholds”, *Review of Accounting Studies*, 10, 465-496.
- Whitworth, J.D. & Lambert, T.A. (2014), “Office –Level Characteristics of the Big 4 and Audit Report Timeliness”, *Auditing: A Journal of Practice & Theory*, 33, 3, 129-152.
- Xie, B., Davidson, W.N., & Dalt, P.J. (2003), “Earnings Management and Corporate Governance: The Role of the Board and the Audit Committee”. *Journal of Corporate Finance* 9, 295-316
- Yulianti, (2004), “Penggunaan Distribusi Laba dalam Mendeteksi manajemen Laba”, *Jurnal Akuntansi dan Keuangan Indonesia*, 1, 2, 89-104.



**THE IMPACT OF WORK-FAMILY CONFLICT TOWARD JOB PERFORMANCE –
THE CASE OF EXTERNAL AUDITOR**

Maria Kharisma Bulu Geroda

President University Jabababeka

Evita Puspitasari

Universitas Padjadjaran Jl. Dipati Ukur No. 35 Bandung 40132 – Indonesia
+628156072882; evitapuspitagumilar@gmail.com; evita.puspitasari@unpad.ac.id

Abstract

The purpose of this study is to explain about how work-family conflict affects auditor which in this case is job performance. Further, this study also investigates the mediating relationship between job satisfaction and organizational commitment. The research is done using 30-items instrument that are given to public accounting firms that listed in IAI. Demographic profiles asked are gender, working experience, education, living with family, and public accounting firm. The analysis was performed on 82 responses using SEM analysis to find out the relationship between variables and how do they imply in auditors who live in JABODETABEK. While some of the previous research found that job satisfaction had insignificant relationship with job performance, analysis showed that work-family conflict had significant negative relationship with job satisfaction and organizational commitment. The next result suggested that job satisfaction and organizational commitment had significant positive relationship with job performance. Analysis also indicated that job satisfaction and organizational commitment mediates relationship between independent variable and dependent variable partially.

Keywords: *Work-Family Conflict, Job Satisfaction, Organizational Commitment, Job Performance, Auditor.*

JEL Classification: *L42*



INTRODUCTION

Working in public accounting firm is closely related to long working hours, excessive job responsibility, and lack of social life outside the working environment, especially on busy season. It is shown that professions with high degree of contact with customers and clients are more susceptible to work-family conflict such as salesperson (Dubinsky et al. 1986), customer service providers (Boles and Babin 1996), and accounting profession as well (Pasewark and Viator 2006). Therefore, we assume that external auditors are vulnerable to work-family conflict.

The term work-family conflict is not recently heard issues in accounting profession, and in this case, external auditors. As they endure the life cycle of an auditor as a profession risk, it is undeniable that the turnover rate of external auditor profession is relatively high. Work family conflict has significant impact toward the turnover intention (Pasewark and Viator, 2006; Haar and Roche, 2012). However, there are no studies yet proving that work-family conflict has direct impact toward the job performance.

Previous studies showed that work family conflict has negative relationship toward job satisfaction (Boles et al. 2001; Anderson et al. 2002) and organizational commitment (Carlson, et al. 2000). In the other hand, job satisfaction has positive relationship toward job performance (Aftab & Idrees, 2012; W. Fu and S. P. Deshpande, 2014) and organizational commitment (Jaramillo, et al. 2005).

Therefore, in this study we intend to elaborate and to seek the empirical evidence on how the work-family conflict affects the quality of auditor's job performance in conducting an audit, and how does job satisfaction and organizational commitment affect job performance and work-family conflict.

THEORETICAL FRAMEWORK AND HYPOTHESES DEVELOPMENT

Job Performance

Job performance is perceived as the result of the job performed by one personnel. In this case, job performance will refer to auditor's job performance. One of the most notable theory of job performance is Campbell's theory about the eight factor model to capture



dimensions of job performance. Those eight factors are consisting of task-specific behaviors, non-task specific behaviors, communication, effort, personal discipline, helps out the groups of colleagues, supervisor or leadership component, and managerial task (Campbell, 1990). We assume that job performance of an auditor directly impacts public trust, and the usefulness of audit itself, as stated by Fisher (2001). Meanwhile, poor job performance may lead to errors, legal liability, and loss credibility (Kalbers and Cenker, 2008). Job performance of an auditor has significant impact toward the outcomes of audit quality, revenues, legal exposure, and even the existence of the accounting firm itself (Kalbers and Cenker, 2008).

Work-Family Conflict and Job Performance

Work family conflict is defined as form of role conflict in which the pressures from work and family domains are mutually incompatible in some respect (Greenhaus and Beutell, 1985). This term could be illustrated as how a person who has dual-role, a parent and a professional auditor, have conflict within his family circle and professional responsibility. Recent studies states that work-family conflict has two perspectives in defining the conflict; they are family interfering work and work interfering family. This two-dimension perspective to conflict is established by the previous researchers.

Based on the studies, it is well established that conflict occurs in the workplace and enters the home (referred to as work interfering family) or occurs in the home and enters the workplace (family interfering work) (Eby, Casper, Lockwood, Bordeaux & Brinley, 2005). There are three indicators of work-family conflict, which are time-based conflict, strain-based conflict and behavior-based conflict (Slan-Jerusalim & Chen, 2009). Time-based conflict defines as a conflict caused by time such as overtime and long working hours (Greenhaus & Beutell, 1985; Ling Xu, 2009). Strained-based conflict is a conflict caused by physical exhaustion, depression, and irritability (Greenhaus, Parasuraman, Granrose, Rabinowitz & Beutell, 1989, Ling Xu, 2009). Behavior-based conflict is a conflict when different behavioral expectations between two roles are incompatible such as the role as a father and as an auditor (Greenhaus et al., 1989 Ling Xu, 2009).



Work interfering family occurs when problems in the work environment interferes the family of one person. For instance, an auditor works overtime because the release date of audit report is getting closer that results him could not make it on his father's birthday at the following day. Bringing audit working paper to house and continue the work there is also considered as work interfering family conflict. Work interfering family could result in lower quality of family life (Vallone & Donaldson. 2001).

Family interfering work occurs in the other way. An example about this dimension is when the auditor take days off to take cares his or her sick children. Several studies were conducted to dig deeper about family interfering work. Researchers found that family interfering work has relationship with organizational commitment (Akintayo, 2010), life satisfaction (Vallone & Donaldson. 2001), and clinical depression (Vallone & Donaldson. 2001).

Job Satisfaction

There are many concepts and researcher's statements underlying job satisfaction. As for the definition, job satisfaction is a positive emotional state gained from the appraisal of job or job experience (Locke, 1976, p. 1300). In the other hand, Spector (2002) states the satisfaction of job is ranged from satisfaction to dissatisfaction. His statement was supporting the popular theory, Motivation Hygiene Theory. This theory states that in there are majorly two factors affect job satisfaction, motivators such as challenging work and recognition; and hygiene factors such as job security and salary. Motivators will lead to job satisfaction while hygiene factors will lead to job dissatisfaction (Herzberg, 1964; Teck-Hong & Waheed, 2011). According to Rusbult and Farrel (1983) job satisfaction is the degree when an individual perceives his or her job positively, the job offers higher rewards and lower cost. Job cost is associated with numerous work load, unfair promotion, inadequate resources, and deadlines, while job offers is associated with high salary and allowance, authority and variation (Rusbult and Farrel, 1983).



Organizational Commitment

According to Rusbult and Farrel (1983), organizational commitment is a tendency of an individual will stay in a particular organization. Organizational commitment has direct impact toward turnover. One notable theory about organizational commitment is the theory of Meyer and Allen (1991). Organizational commitment is perceived as the intention of employee in an organization to continue working (Meyer, Allen. 1991; Jaros, 2007). Organizational commitment could be formed from many aspects of work. Organizational commitment is divided into three aspects, affective commitment, continuance commitment, and normative commitment.

Affective commitment arises when employee has sentimental feeling, emotional attachment and involvement with the particular organization. Employees are staying in an organization because they want to be there. Continuance commitment is the decision made by employee when he or she perceived that it will be more beneficial or less costly to stay in the particular organization. Normative commitment is occurred when employee feels staying in one organizational is not a choice, they feel that they have to be in that organization due to normative reasoning and values (Meyer, Allen. 1991; Brown, Barbara B. 2003).

Hypotheses Development

Relationship between Work-Family Conflicts with Job Satisfaction

According to the role theory, relationship occurs between work-family conflict and job satisfaction is negative. When the work-family conflict increases, the job satisfaction will decrease (Kahn et al., 1964; Pasewark & Viator, 2006). To illustrate this relationship, assumed that an auditor has to go out of town in regard of field-work activities for two weeks. However, at that week, she is going to celebrate marriage anniversary with her spouse. The husband feel disappointed knowing that his wife, which is the auditor, cannot spare time for celebrating their anniversary due to work business.

This is an example how work interfere the family and can possibly lowering the quality of family life, especially when it occurs frequently. Illustration mentioned above is using the dimension of Work Interfering Family concept, where job satisfaction is decreasing



because the auditor perceives that her job is the root problem of her spouse disappointment is related to her work. The correlation of Work Interfering Family and Job satisfaction is found to be negative (Boles et al., 2001; Anderson et al., 2002; Pasewark and Viator, 2006). In the other hand, the relationship of Family Interfering Work with Job Satisfaction is found to be either negative but insignificant (Netemeyer et al. 1996), or non-existent. Based on these theories and explanation, therefore we propose hypothesis as below:

H1: Work-Family conflict has negative relationship toward job satisfaction

Relationship between Work-Family Conflicts with Organizational Commitment

Work-family conflict causes imbalance between family and work when an auditor should be able to prioritize one thing at a time. The disruption affects the organizational commitment of an auditor. The conflicts of interest between work and family that have impact for the organization would affect the organizational commitment (Akintayo, D. I. 2010). Previous research found that work family conflict has significant negative relationship with overall organizational commitment (Malik, Shoukat, et al. 2015).

Based on these findings, we propose hypothesis as follows:

H2: Work Family Conflict has negative relationship with organizational commitment.

Relationship between Job Satisfaction with Job performance

According to previous researches, job satisfaction has a significant impact toward job performance. There is significantly positive relationship between job satisfaction and task performance (Edward and Bell, 2008). Moreover it is suggested that firm can improve their employee's performance by increasing their job satisfaction and motivation (Springer, 2011). There were many previous researchers examined the relationship between job satisfaction and job performance.

Each research has its own way to determine the relationship between two variables, such as G. Strauss (1968) commented, "Early human relationists viewed the morale-productivity relationship quite simply: higher morale would lead to improved productivity" (p. 264), or Job satisfaction is especially important in service or business with high level of



working level. Shore and Martin (1989) found job satisfaction explained more incremental variance in the performance of professionals than organizational commitment.

Therefore the hypothesis is formed as below:

H3: Job satisfaction has positive relationship with job performance.

Relationship between Organizational Commitments with Job performance

The relationship between organizational commitment and job performance is positive (Jaramillo, et al. 2005). Previous researchers define the relationship of organizational commitment and employee's job performance is positive in the comparative analysis from Meyer's three aspects of organizational commitment (W. Fu, S. P. Deshpande. 2014). Previous research found that work family conflict has significant negative relationship with overall organizational commitment (Malik, Shoukat, et al. 2015).

Based on the previous findings, researcher forms the hypothesis as below:

H4: Organizational commitment has positive relationship with job performance.

Relationship between Work-Family Conflict, Job Satisfaction, Organizational Commitment and Job performance

Based on previous research, work-family conflict is one among several indicators that affects the auditor job performance, whether the auditors is feeling satisfied or not satisfied with their job and feel committed in an accounting firm. Work-family conflict has different effect toward different professions. However, studies show that professions with high customer/client contact are high likely to suffer from work family conflict (Dubinsky, et al., 1986; Boles and Babin, 1996).

Pasewark and Viator (2006, p.159) through their research find that accounting professionals feel dissatisfied with their work when it interferes the family activities, but their job satisfaction is not necessarily affected by job interference. In the other hand, organizational commitment also plays important role with significant relationship with work-family conflict (Malik, Shoukat. et al. 2015) and job performance (Jaramillo, et al. 2005). Therefore, the hypothesis is formed as below:



H5: Job satisfaction and organizational commitment will mediate the relationship between work family-conflict and job performance.

RESEARCH DESIGN

Empirical Design

The purpose of this study is to explain about how work-family conflict affects auditor job performance, and how do job satisfaction and organizational commitment mediate relationship between both variables.

Below is the research model we use in this study:



Figure 1

Instruments

Independent Variable

The independent variable in this research is the work-family conflict. To measure the work-family conflict, we use questionnaire used by Pasewark and Viator at their research (2006). This questionnaire comes from Netemeyer et al.'s (1996) two-dimensional measure of work-family conflict. This questionnaire measures both WIF (Work Interfering Family) and FIW (Family Interfering Work). The measurement we used that contain each dimension of work-family conflict is using five-likert scale.

Mediating Variable

The mediating variable in this research is job satisfaction. To measure the job satisfaction, we use questionnaire used six items from Rusbult and Farrell (1983) previously

used in other accounting studies (Pasewark, Viator. 2006). Organizational commitment will be measured using 15-items from Allen & Meyer that used in previous research (Lee, Allen, et al. 2001) both job satisfaction and organizational commitment will use 5-likert scale for measurement.

Dependent Variable

The dependent variable for this research is the job performance. To measure job performance, we use questionnaire from Fogarty, Singh, Rhoads, and Moore (2000) and Fogarty and Kalbers (2005) used to determine job performance in other behavioral accounting studies (Kalbers & Cenker, 2008) using five-likert scale.

Hypothesis Testing

The purpose of this study is to explain about how work-family conflict affects auditor which in this case is job performance, and how do job satisfaction and organizational commitment mediate relationship between both variables. Hypothesis Testing using SEM Analysis, with Variance Accounted For (VAF) Test to check mediating effects in this research.

Sample

The population for this research is external auditor who work in JABODETABEK. The sample target for this research is 100 (one hundred). Researcher is going to use primary source of data, which refers to first-handed obtained data. The collection method is by spreading questionnaire. The sampling method to use is simple random sampling. The criteria for the samples itself are as listed below:

- a. Posses work experience as an auditor in public accounting firm.
- b. Auditor from big four and non big four public accounting firm located in JABODETABEK.

Researcher able to spread 100 questionnaires with 82 usable responses. Researcher asked information about gender, working experience, education, living status, and classification of public accounting firm in the questionnaire sheet. There are more male



respondents compared to female respondents. There are 37 (45,1%) female respondents and 45 (54,9%) male respondents.

RESULTS

Descriptive Analysis

Referring to the data, for variable WFC, the average score was 2,473; median score 2; modus score 2; and standard deviation 0,872. Looking from the descriptive results, most of the respondents were choosing answered 2 which refers to “disagree” (in 5 likert scale; 1 = Very Disagree and 5 = Very Agree). Referring to the result, we assumed that most of the respondents did not found work-family conflict as big obstacles in their career or even did not experience work-family conflict at all. However, the answers for this variable was the most varied compared to other variables. Although most respondents found work-family conflict was not an obstacle, some respondents found work-family conflict as an extreme burden for their profession. Looking deeper into the answers, variable WFC had two indicators which were work interfering family and family interfering work. Questions WFC 1, WFC 2, WFC 3 and WFC 4 were for indicator family interfering work, while WFC 5, WFC 6, WFC 7, WFC 8, and WFC 9 were for indicator work interfering family. As shown in the table, most of the respondents’ answered toward question related to family interfering work were “very disagree” and “disagree”. From this result, we concluded that family interfering work was not really happening in auditors’ life, or even if it was, family interfering work was not really considered as a burden. In the other hand, for question related to work interfering family, respondents’ answered were more varied. Although most answers were still in “disagree” and “neutral” area, number of respondents who answered “agree” also could not be ignored. This showed that working as an auditor, to some extent, was taking individual’s time for hwas or her family.

For variable JS, the average score was 3,510; median score 3; modus score 4; and standard deviation 0,727. Therefore, most of the respondents were choosing answered 4 which refers to “agree” in JS section. Looking from the result, it was shown that most of the auditors were felting neutral or satisfied with their current profession. The indicator of the job



satisfaction was cost and reward. Indicator cost was stated in JS 1 and JS 5 while indicator reward was stated in JS 2, JS 3 and JS 4. Referring to the data, we concluded that most of the respondents found that the cost to become an auditor was worth for the reward.

For variable OC, the average score was 3,299; median score was 3; modus score was 3; and the standard deviation was 0,897. Therefore most of the respondents were choosing answered 3 which refers to “neutral” in OC section. However, looking at the mean score, it showed that although most of the auditors were answering “neutral”, it was very likely that auditors felt “neutral to committed” toward their job. Looking deeper to the answers, there were three indicators of organizational commitment, which were normative commitment, continuance commitment, and affective commitment. Normative commitment was stated in OC 1, OC 2, OC 3, and OC 4; continuance commitment was stated in OC 5, OC 6, OC 7; and affective commitment was stated in OC 8, OC 9, OC 10, and OC 11. From the distribution of the answers, it was shown that from three indicators that auditors felt high degree of affective commitment toward their accounting firm. While normative and continuance commitment were more varied from one to other respondents, more than half of the respondents choose “agree” and “strongly agree” when it came to affective commitment question. Affective commitment could be occurred when someone felt comfortable and happy in the situation. Some things that could increase affective commitment for auditors were the suitable working culture, the colleagues, the supervisors, and how far the auditors enjoy their profession as well.

For variable JP, the average score was 3,483; median was 3; modus was 3; and standard deviation was 0,786. Therefore most of the respondents were choosing score 3 which refers to “neutral” in JP section. Looking deeper to the indicators, variable JP had two indicators which were quality of work and quantity of work. Quality of work was stated in JP 2, JP 3, and JP 5; while quantity of work was stated in JP 1 and JP 4. Referring to table 4.3e, we concluded that most of the respondents were either “neutral” or “agree” with job quality. In the other hand, when the question was about “quantity of job” the respondents were more varied, especially in JP 4 “I perform better than my other colleagues with same level”. The result showed that respondents were feeling more “confident” about their job quality while



feeling “neutral” about job quantity. All data had low standard deviation, which was also a hint that data was clustered around the average score and most likely to be reliable.

DISCUSSION

Interpretation Analysis of Work-Family Conflict and Job Satisfaction

As shown in the previous results, WFC and JS had negative relationship. This meant that the more conflict between work and family experienced by auditors, job satisfaction of the auditor will decrease. Back to the indicators of job satisfaction, cost and reward, if auditors suffer too much work-family conflict that mainly generated from the workplace, auditors will start to feel that the rewards they got from their job was not worth with the cost and the sacrifice made. Looking at the p value which was <0.01 , it showed that work-family conflict had significant impact toward job satisfaction. Having demanding profession and pursue to balance it with family life was a challenging issue. Looking from the R-square value which was 17%, it showed that the changes in work-family conflict could slightly affect job satisfaction of an auditor.

The result was similar to the previous researches that work-family conflict overall had negative relationship with job satisfaction, and referring to the descriptive results presented earlier in the chapter, indicator family interfering family was not really affecting auditor compared to work interfering family, because it was insignificant (Pasewark and Viator. 2006; Lidya Agustina. 2008).

Work-family conflict issue could be overcome when public accounting firm also take active action to overcome it. One of the solutions could be provided was that policy to add one day off per 8-hours of overtime. Therefore, the time spent for working could be made up more during low season. Public accounting firm could also consider to make certain event such as “family day” or give special privilege for auditors for “one special day off given by firm” that could be used for family event (anniversary, kid’s birthday). Thus, auditors felt more appreciated with their work.



Interpretation Analysis of Work-Family Conflict and Organizational Commitment

Next was about WFC and OC. Variables WFC and OC had negative relationship, this meant that the more conflict between work and family experienced by auditors, organizational commitment would be decreasing. Back to the indicators of organizational commitment, normative commitment, continuance commitment, and affective commitment, if auditors suffer too much work-family conflict that mainly generated from the workplace, auditors will start to felt detached with their organization.

Looking at the p value which was <0.01 , it showed that work-family conflict had significant impact toward organizational commitment. As shown in the descriptive result, out of three indicators of organizational commitment, auditors had highest degree of affective commitment which means that the auditor had committed with the firm because they choose to be committed, not because of external forces or factors. Therefore, the organizational commitment owned by auditors was more vulnerable to work-family conflict because the strongest commitment was from inner personal commitment.

Looking from the R-square value which was 26.7%, it showed that the changes in work-family conflict could moderately affect organizational commitment of an auditor. This also showed that work-family conflict had bigger effect toward organizational commitment compared to job satisfaction. This result was consistent with the previous we that state work-family conflict had significant negative relationship with overall organization commitment, and also consistent with the previous we, affective commitment held the most significant relationship with work-family conflict. (Shoukat Malik, et al. 2015).

Interpretation Analysis of Job Satisfaction and Job Performance

As shown in the previous results, JS and JP had positive relationship. This meant that the higher job satisfaction could also relate to higher job performance. Looking at the p value which was <0.01 , it showed that job satisfaction had significant relationship toward job performance. The more auditors felt satisfied with their job, it was very likely that they will put more effort for their job, thus the job performance will be increasing.

Looking from the R-square value which was 11.5%, it showed that the changes in job satisfaction could slightly affect the job performance of an auditor. This result was slightly



inconsistent with the previous study. Previous we stated that job satisfaction and job performance indeed had positive relationship, however, it was not significant (Fu and Deshpande. 2014). However, this result was consistent with another we's result that job satisfaction and job performance were positively influential, higher job satisfaction will lead to better job performance, betterment of job performance will lead to even higher job satisfaction (Yang and Hwang. 2014). This slight difference could be occurred from conditional bias, difference in demographic, or difference in sample numbers.

Interpretation Analysis of Organizational Commitment and Job Performance

Next was about OC and JP. According to the results above, OC and JP had positive relationship. This means that the more committed an auditor to his or her firm, it could lead to better job performance. Same goes to JS, the more an auditor committed to their firm, it was very likely that they will put more effort and spend more time and energy to their job which lead to better job performance. Looking at the p value which was <0.01 , it showed that organizational commitment had significant relationship with job performance. Looking from the R-square value which was 10.9%, it showed that the changes in organizational commitment could affect job performance. However, the effect of organizational commitment toward job performance was less than job satisfaction. This result was consistent with the previous we (Fu and Deshpande. 2014) that states organizational commitment had positive and significant impact toward job performance.

Interpretation Analysis of Mediating Effects

Lastly about mediating effect, as stated in the result above that OC and JS was partially mediating the relationship between the WFC and JP. It means that WFC had both direct and indirect impact toward JP, the direct effect was not mediated, whereas the indirect effect was mediated by JS and OC. This could refer that some indicators of work-family conflict had direct effect toward job performance, and the other indicators had indirect effect toward job performance. The role of JS and OC here as mediating variable was to transmit the indirect effect from WFC toward JP. Referring to the descriptive analysis above, we suggest that indicator that had direct effect toward job performance was work interfering



family while family interfering work do not had any direct effect toward job performance, thus mediation through job satisfaction and organizational commitment was occurred in this relationship.

Previous studies analyze the effect of work-family conflict toward performance using another mediating variable such as emotional exhaustion the result was that emotional exhaustion fully mediate the relationship between work-family conflict and job performance, therefore, there was no direct impact from work-family conflict to job performance (Karatepe, 2013). However, according to another previous research (Warokka and Febrilia. 2015), work-family conflict had overall negative relationship with job performance and between two indicators, only work interfering family that had direct impact toward job performance. Therefore, we concluded that this result was consistent with the previous research.

CONCLUSION & IMPLICATION

The more conflict occurred between work and family, auditor felt even more burden so that it would impact negatively toward his/her job satisfaction, and it was significant. Work interfering family had higher impact for auditors compared to family interfering work. The more work-family conflict occurred between work and family would lead auditor to felt detached with the organization or the firm where auditors were working in. Affective commitment held the most account for organizational commitment owned by auditors. The more job satisfaction an auditor had within their profession, it was more likely that auditors will had more motivation to do their job even better. Therefore, job satisfaction impacts job performance positively. The more committed an auditor toward their profession, auditors would have more motivation and willingness to perform their best on their job. Therefore, organizational commitment affected job performance positively. Job satisfaction and organizational commitment mediated the relationship between work family conflict and job performance partially. There was direct relationship between work-family conflict and job performance as well.

We suggested some recommendations for future study purpose. Future research could be done in another demography area. Future research could also do comparative research



between big four accounting firm and non-big four accounting firm regarding this topic. Future research could be done for internal auditors or accountant who works in company. Future research could also consider to add mediating variable such as “professionalism”.

Public accounting firm should give certain work-family friendly policies such as additional off day for every 8-hours of over-time. Public accounting firm also could consider to hold certain event in the low season that involve the family of the auditor

REFERENCES

- Aftab, H., & Idrees, W. (2012). A Study of Job Satisfaction and IT's Impact on the Performance in the Banking Industry of Pakistan. *International Journal of Business and Social Science*, 174-180.
- Agustina, L. (2008). Pengaruh Work-Family Conflict Terhadap Job Satisfaction dan Turnover Intention Pada Profesi Akuntan Publik. *Jurnal Ilmiah Akuntansi*, 100-116.
- Ahmad, M. S., & Masood, M. T. (2011). Work Family Conflict among Women University Teachers: A Case from Pakistan. *European Journal of Social Sciences*, 119-130.
- Akintayo, D. (2010). Work-family role conflict and organizational commitment among industrial workers in Nigeria. *International Journal of Psychology and Counselling*, 1-8.
- Anderson, S., Coffey, B., & Byerly, R. (2002). Formal Organizational Initiatives and Informal Workplace Practices: Links to Work-Family Conflict and Job-Related Outcomes. *Journal of Management*, 787-810.
- Boles, J., & Babin, B. (1996). On the front lines: Stress, Conflict, and the Customer Service Provider. *Journal of Business Research*, 41-51.
- Boles, J., Howard, G., & Donofrio, H. (2001). An Investigation Into the Inter-relationships of Work-Family Conflict, Family-Work Conflict and Work Satisfaction. *Journal of Managerial Issues*, 376-390.
- Brown, B. (2003). Employees' Organizational Commitment and Their Perceptions of Supervisors; Relations-Oriented and Task-Oriented Leadership Behavior. Dissertation submitted to the Faculty of the Virginia Polytechnic Institute and State University. Falls Church, Virginia.



- Bruck, C., Allen T., & Spector P. (2002). The Relation between Work-Family Conflict and Job Satisfaction : A Finer Grained Analysis. *Journal of Vocational Behavior* 60, 336-353.
- Campbell C.H., & F. (1990). Development of Multiple Job Performance Measures in a Representative Sample of Jobs. *Personnel Psychology*, 277-300.
- Carlson , D., Kacmar K., & L. Williams. (2000). Constructional and Initial Validation of a Multidimensional Measure of Work-Family Conflict. *Journal of Vocational Behavior* 56, 249-276.
- Dubinsky, A. (1986). Salesforce Socialization. *Journal of Marketing* 50, 192-207.
- Eby, L. T., Casper, W., Lockwood, A., Bordeaux, C., & Brinley, A. (2005). A retrospective on work famiy research in IO/OB: A content analysis and review of the literature[Monograph] . *Journal of Vocational Behavior*, 124-197.
- Edwards, B., Bell, S., Winfred, A. J., & Decuir, A. D. (2008). Relationships between Facets of Job Satisfaction and Task and Contextual Performances. *Applied Psychology: An International Review*, 441-465.
- Fisher, R. (2001). Role Stress, the Type A Behavior Pattern, and External Auditor Job Satisfaction and Performance. *Behavioral Research in Accounting*(13),
- Fogarty, T. J., Singh, J., Rhoads, G. K., & Moore, R. (2000). Antecedents and consequences of burnout in accounting: beyond the role stress model. *Behavioral Research in Accounting*, 31-67.
- Greenhaus, J., & Nicholas J. Beutell. (1985). Source of Conflict Between Work and Family Roles. *The Academy of Management Review* 10(1), 76-88.
- Greenhaus, J., Parasuraman, S., Granrose, C., Rabinowits, S., & Beutell, N. (1989). Sources of Work-Family Conflict among Two Carrier Couples. *Journal of Vocational Behavior*, 133-143.
- Haar, J. M., Roche, M., & Taylor, D. (2012). Work-Family Conflict and Turnover Intentions of Indigenous Employees: The Importance of the Whanau/Family for Maori. *The International Journal of Human Resource Management*, 2546-2560.
- Herzberg, F. (1964). The Motivation-Hygiene Concept and Problems of Manpower. *Personnel Administration*, 3-7.



- Hoyle, R. H. (1995). *Structural Equation Modelling*. Thousand Oaks.
- Jaramillo, F., Mulki, J. P., & Marshall, G. (2005). A Meta-Analysis of the Relationship between Organizational Commitment and Salesperson Job Performance : 25 Years of Research. *Journal of Business Research* 58, 705-714.
- Jaros, S. (2007). Meyer and Allen Model of Organizational Commitment: Measurement Issues. *The Icfai Journal of Organizational Behavior* , 7-25.
- Judge, T., Bono, J. E., Thoresen, C. J., & Patton, G. K. (2001). The Job Satisfaction - Job Performance Relationship : A Qualitative and Quantitative Review. *Psychological Bulletin*, 127, 376-407.
- Kahn, R., Wolfe, D., Quinn, R., Snoek, J., & Rosenthal, R. (1965). *Organizational Stress; Studies in role conflict and ambiguity*. New York. *Administrative Science Quarterly*, 125-129.
- Kalbers, L. P., & Fogarty, T. (1995). Professionalism and Its Consequences: A Study of Internal Auditors. *Journal of Practice and Theory*, 64-86.
- Kalbers, L. P., & Fogarty, T. J. (2005). Antecedents of Internal Auditor Burnout. *Journal of Managerial Issues*, 101-118.
- Kalbers, L., & Cenker, W. (2008). The Impact of Exercised Responsibility, Experience, Autonomy, and Role Ambiguity on Job Performance in Public Accounting. *Journal of Managerial Issues*, 327-347.
- Karatepe, O. (2013). The effects of work overload and work-family conflict on job embeddedness and job performance: the mediation of emotional exhaustion. *International Journal of Contemporary Hospitality Management*, 614-634.
- Lee, K., Allen, N., Meyer, J., & Rhee, K.-Y. (2001). The Three-Component Model of Organisational Commitment: An Application to South Korea. *Applied Psychology: An International Review*, 596-614.
- Locke, E. (1976). The Nature and Causes of Job Satisfaction in M.D. Dunnette. *Handbook of Industrial and Organizational Psychology*, 1297-1349.
- Malik, S., Abdul, G. A., & Qurat-ul-Ain. (2015). Role of Work Family Conflict on Organizational Commitment and Organizational Effectiveness . *European Journal of Business and Management*, 222-229.



- Martin, H., & Shore, L. (1989). Job Satisfaction and Organizational Commitment in Relation to Work Performance and Turnover Intention. *Human Relations*, 625-638.
- Meyer, J., & Allen, N. (1991). A Three-Component Model Conceptualization of Organizational Commitment. *Human Resource Management Review*, 61-89.
- Netemeyer, R., Robert M., & James S. B. (1996). Development of Validation of Work-Family Conflict and Family-Work Conflict Scales. *Journal of Applied Psychology*, 400-410.
- Pasewark, W., & Viator, R. E. (2006). Sources of Work-Family Conflict in the Accounting Profession. *Behavioral Research in Accounting*, 18, 147-165.
- Rusbult, C. E., & Farrell, D. (1983). A Longitudinal Test of the Investment Model: The Impact of Job Satisfaction, Job Commitment, and Turnover of Variations in Rewards, Costs, Alternatives, and Investments. *Journal of Applied Psychology*, 429-438.
- Sholihin, M., & Ratmono, D. (2013). Analisis SEM-PLS dengan Warp PLS 3.0. Yogyakarta: Penerbit ANDI.
- Slan-Jerusalim, R., & Chen, C. (2009). Work-Family Conflict and Career Development Theories : A Search for Helping Strategies. *Journal of Counseling of Development : JCD*, 492-500.
- Springer, G. (2011). A Study of Job Motivation, Satisfaction, and Performance among Bank Employees. *Journal of Global Business Issues*, 29-42.
- Strauss, G. (1968). Human Relations - 1968 Style. *Industrial Relations*, 262-276.
- Teck-Hong, T., & Waheed, A. (2011). Herzberg's Motivation-Hygiene Theory and Job Satisfaction in the Malaysian Retail Sector : The Mediating Effect of Love of Money. *Asian Academy of Management Journal*, 73-94.
- Vallone, E., & Donaldson, S. (2001). Consequences of work-family conflict on employee well-being over time. *Work & Stress*, 214-226.
- Wai, C. K., M., T. G., Y., T. S., Toh, S. Y., & Yap, Y. M. (2013). The relationship between work stress and auditor's job performance. Malaysia, Petaling Jaya: University Tunku Abdul Rahman.
- Warokka, A., & Febrilia, I. (2015). Work-Family Conflict and Job Performance: Lesson from a Southeast Asian Emerging Market. *Journal of Southeast Asia Research*, 1-14.



- Weihui, F., & Deshpande, S. P. (2014). The Impact of Caring Climate, Job Satisfaction, and Organizational Commitment on Job Performance of Employees in China's Insurance Company. *Journal of Business Ethics*, 339-349.
- Xu, L. (2009). View on Work-Family Linkage and Work-Family Conflict Model. *International Journal of Business and Management*, 229-233.
- Yang, C.-L., & Hwang, M. (2014). Personality Traits and simultaneous reciprocal influences between job performance and job satisfaction. *Chinese Management Studies*, 6-26.



1 = Sangat tidak setuju || 2 = Tidak setuju || 3 = Netral/Biasa saja || 4 = Setuju || 5 = Sangat Setuju

16	Saya tidak merasakan rasa kepemilikan terhadap kantor saya	<input type="checkbox"/>	<input type="checkbox"/>	<input type="checkbox"/>	<input type="checkbox"/>	<input type="checkbox"/>	<input type="checkbox"/>	<input type="checkbox"/>	<input type="checkbox"/>
17	Saya tidak memiliki ikatan emosional dengan kantor saya	<input type="checkbox"/>	<input type="checkbox"/>	<input type="checkbox"/>	<input type="checkbox"/>	<input type="checkbox"/>	<input type="checkbox"/>	<input type="checkbox"/>	<input type="checkbox"/>
18	Saya tidak merasa sebagai bagian dari keluarga besar kantor saya	<input type="checkbox"/>	<input type="checkbox"/>	<input type="checkbox"/>	<input type="checkbox"/>	<input type="checkbox"/>	<input type="checkbox"/>	<input type="checkbox"/>	<input type="checkbox"/>
19	Setelah mempertimbangkan semua hal, saya sangat tidak puas dengan pekerjaan saya	<input type="checkbox"/>	<input type="checkbox"/>	<input type="checkbox"/>	<input type="checkbox"/>	<input type="checkbox"/>	<input type="checkbox"/>	<input type="checkbox"/>	<input type="checkbox"/>
20	Dengan hal-hal yang sudah saya ketahui sekarang, kalau saya harus memutuskan lagi apakah mau melakukan pekerjaan ini atau tidak, saya sudah pasti akan memilih profesi ini	<input type="checkbox"/>	<input type="checkbox"/>	<input type="checkbox"/>	<input type="checkbox"/>	<input type="checkbox"/>	<input type="checkbox"/>	<input type="checkbox"/>	<input type="checkbox"/>
21	Jika teman baik saya berkata ingin memiliki profesi seperti saya (dengan atasan saya), saya tidak akan merekomendasikan pekerjaan ini kepada dia	<input type="checkbox"/>	<input type="checkbox"/>	<input type="checkbox"/>	<input type="checkbox"/>	<input type="checkbox"/>	<input type="checkbox"/>	<input type="checkbox"/>	<input type="checkbox"/>
22	Kantor saya sangat berarti bagi saya secara pribadi	<input type="checkbox"/>	<input type="checkbox"/>	<input type="checkbox"/>	<input type="checkbox"/>	<input type="checkbox"/>	<input type="checkbox"/>	<input type="checkbox"/>	<input type="checkbox"/>
23	Saya menyelesaikan lebih sedikit pekerjaan dalam periode tertentu dibanding rekan kerja saya	<input type="checkbox"/>	<input type="checkbox"/>	<input type="checkbox"/>	<input type="checkbox"/>	<input type="checkbox"/>	<input type="checkbox"/>	<input type="checkbox"/>	<input type="checkbox"/>
24	Saya memberikan usulan konstruktif kepada senior/supervisor mengenai bagaimana pekerjaan audit harus dilakukan	<input type="checkbox"/>	<input type="checkbox"/>	<input type="checkbox"/>	<input type="checkbox"/>	<input type="checkbox"/>	<input type="checkbox"/>	<input type="checkbox"/>	<input type="checkbox"/>
25	Pekerjaan seperti ini adalah sangat sesuai dengan pekerjaan ideal saya	<input type="checkbox"/>	<input type="checkbox"/>	<input type="checkbox"/>	<input type="checkbox"/>	<input type="checkbox"/>	<input type="checkbox"/>	<input type="checkbox"/>	<input type="checkbox"/>
26	Pekerjaan ini benar-benar sesuai dengan pekerjaan yang ingin saya ambil ketika saya memilih karir ini	<input type="checkbox"/>	<input type="checkbox"/>	<input type="checkbox"/>	<input type="checkbox"/>	<input type="checkbox"/>	<input type="checkbox"/>	<input type="checkbox"/>	<input type="checkbox"/>
27	Saya tidak merasakan adanya keharusan untuk bertahan dengan kantor saya sekarang	<input type="checkbox"/>	<input type="checkbox"/>	<input type="checkbox"/>	<input type="checkbox"/>	<input type="checkbox"/>	<input type="checkbox"/>	<input type="checkbox"/>	<input type="checkbox"/>
28	Saya menemukan cara untuk meningkatkan prosedur audit	<input type="checkbox"/>	<input type="checkbox"/>	<input type="checkbox"/>	<input type="checkbox"/>	<input type="checkbox"/>	<input type="checkbox"/>	<input type="checkbox"/>	<input type="checkbox"/>
29	Kinerja saya lebih baik daripada auditor lain setingkat saya	<input type="checkbox"/>	<input type="checkbox"/>	<input type="checkbox"/>	<input type="checkbox"/>	<input type="checkbox"/>	<input type="checkbox"/>	<input type="checkbox"/>	<input type="checkbox"/>
30	Mempertahankan dan memperbaiki hubungan dengan klien tidak termasuk sebagai hal penting di pekerjaan saya	<input type="checkbox"/>	<input type="checkbox"/>	<input type="checkbox"/>	<input type="checkbox"/>	<input type="checkbox"/>	<input type="checkbox"/>	<input type="checkbox"/>	<input type="checkbox"/>



1 = Sangat tidak setuju || 2 = Tidak setuju || 3 = Netral/Biasa saja || 4 = Setuju || 5 = Sangat Setuju

1	Tuntutan keluarga saya/pasangan tidak pernah mengganggu pekerjaan saya	<input type="checkbox"/>	<input type="checkbox"/>	<input type="checkbox"/>	<input type="checkbox"/>	<input type="checkbox"/>	<input type="checkbox"/>	<input type="checkbox"/>	<input type="checkbox"/>
2	Saya harus menunda pekerjaan saya karena tuntutan waktu saya di rumah	<input type="checkbox"/>	<input type="checkbox"/>	<input type="checkbox"/>	<input type="checkbox"/>	<input type="checkbox"/>	<input type="checkbox"/>	<input type="checkbox"/>	<input type="checkbox"/>
3	Saya tidak pernah memiliki kesulitan apapun untuk menyelesaikan pekerjaan karena tuntutan/kesibukan di keluarga	<input type="checkbox"/>	<input type="checkbox"/>	<input type="checkbox"/>	<input type="checkbox"/>	<input type="checkbox"/>	<input type="checkbox"/>	<input type="checkbox"/>	<input type="checkbox"/>
4	Walaupun itu demi kebaikan saya, saya tidak merasa keluar dari kantor ini adalah hal yang baik	<input type="checkbox"/>	<input type="checkbox"/>	<input type="checkbox"/>	<input type="checkbox"/>	<input type="checkbox"/>	<input type="checkbox"/>	<input type="checkbox"/>	<input type="checkbox"/>
5	Saya tidak akan merasa bersalah kalau saya keluar dari kantor sekarang	<input type="checkbox"/>	<input type="checkbox"/>	<input type="checkbox"/>	<input type="checkbox"/>	<input type="checkbox"/>	<input type="checkbox"/>	<input type="checkbox"/>	<input type="checkbox"/>
6	Saya akan melanggar/menyalahi kepercayaan jika saya keluar dari kantor saya sekarang	<input type="checkbox"/>	<input type="checkbox"/>	<input type="checkbox"/>	<input type="checkbox"/>	<input type="checkbox"/>	<input type="checkbox"/>	<input type="checkbox"/>	<input type="checkbox"/>
7	Teman dan keluarga saya menghabiskan waktu yang sebenarnya ingin saya gunakan untuk bekerja	<input type="checkbox"/>	<input type="checkbox"/>	<input type="checkbox"/>	<input type="checkbox"/>	<input type="checkbox"/>	<input type="checkbox"/>	<input type="checkbox"/>	<input type="checkbox"/>
8	Tuntutan pekerjaan mengganggu kehidupan pribadi saya (keluarga, waktu senggang)	<input type="checkbox"/>	<input type="checkbox"/>	<input type="checkbox"/>	<input type="checkbox"/>	<input type="checkbox"/>	<input type="checkbox"/>	<input type="checkbox"/>	<input type="checkbox"/>
9	Waktu yang dihabiskan oleh pekerjaan saya membuat saya kesulitan mengikuti acara keluarga atau tanggung jawab pribadi yang lainnya	<input type="checkbox"/>	<input type="checkbox"/>	<input type="checkbox"/>	<input type="checkbox"/>	<input type="checkbox"/>	<input type="checkbox"/>	<input type="checkbox"/>	<input type="checkbox"/>
10	Menurut saya, saya akan mengalami lebih banyak kerugian daripada keuntungan kalau keluar dari kantor saya	<input type="checkbox"/>	<input type="checkbox"/>	<input type="checkbox"/>	<input type="checkbox"/>	<input type="checkbox"/>	<input type="checkbox"/>	<input type="checkbox"/>	<input type="checkbox"/>
11	Saya tidak akan meninggalkan kantor ini karena kehilangan/kerugian yang bisa menimpa saya nantinya	<input type="checkbox"/>	<input type="checkbox"/>	<input type="checkbox"/>	<input type="checkbox"/>	<input type="checkbox"/>	<input type="checkbox"/>	<input type="checkbox"/>	<input type="checkbox"/>
12	Jika saya memutuskan untuk meninggalkan kantor ini, terlalu banyak hal di hidup saya yang akan kacau/terganggu	<input type="checkbox"/>	<input type="checkbox"/>	<input type="checkbox"/>	<input type="checkbox"/>	<input type="checkbox"/>	<input type="checkbox"/>	<input type="checkbox"/>	<input type="checkbox"/>
13	Hal-hal yang ingin saya lakukan di rumah jadi tidak bisa dikerjakan karena tuntutan pekerjaan saya	<input type="checkbox"/>	<input type="checkbox"/>	<input type="checkbox"/>	<input type="checkbox"/>	<input type="checkbox"/>	<input type="checkbox"/>	<input type="checkbox"/>	<input type="checkbox"/>
14	Pekerjaan saya tidak membuat saya tertekan sehingga mudah bagi saya untuk memenuhi kewajiban pribadi atau di keluarga	<input type="checkbox"/>	<input type="checkbox"/>	<input type="checkbox"/>	<input type="checkbox"/>	<input type="checkbox"/>	<input type="checkbox"/>	<input type="checkbox"/>	<input type="checkbox"/>
15	Tuntutan pekerjaan tidak mempengaruhi waktu bersantai saya di rumah atau dengan teman-teman	<input type="checkbox"/>	<input type="checkbox"/>	<input type="checkbox"/>	<input type="checkbox"/>	<input type="checkbox"/>	<input type="checkbox"/>	<input type="checkbox"/>	<input type="checkbox"/>

Table - Descriptive Analysis

	WFC	JS	OC	JP
Mean	2,473	3,510	3,299	3,483
Median	2	3	3	3
Modus	2	4	3	3
Standard Deviation	0,872	0,727	0,897	0,786

Source: Research Data



Results

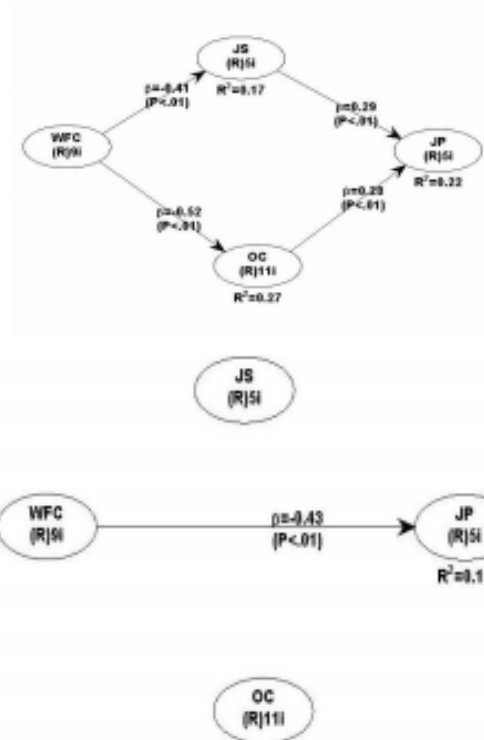

**OIL PRICE AND BANKRUPTCY PROBABILITY OF OIL AND GAS COMPANIES
(STUDIES IN 3 ASIA-PACIFIC COUNTRIES)**

Dini Rosdini

Rahardi Gita Nautika

Universitas Padjadjaran

dini.rosdini@unpad.ac.id*

rahardigita@gmail.com

Abstract

The decline in oil prices is not only happen to oil prices in Indonesia, but also world oil prices. The world oil prices downturn has an impact on the world's oil and gas companies financial health. This study aims to provide empirical evidence about the effect of oil prices on the probability of bankruptcy in Indonesia, Singapore, and Australia.

The probability of bankruptcy in this study is measured by Altman Z-Score, developed by Edward Altman (1968). The price of oil in this study is measured by the price of Brent crude. The sample was 20 manufacturing firms listed at Indonesia Stock Exchange (IDX), Australian Securities Exchange (ASX) and Singapore Exchange (SGX) during the period 2013-2015 selected through purposive sampling

The results of this study indicate that by using simple regression model, oil prices significantly influence the probability of oil and gas companies in Indonesia, Singapore, and Australia.

Keywords: Oil Price, Probability of Bankruptcy, Altman Z-Score, Purposive Sampling, Simple Regresion Model

JEL Classification: O57

INTRODUCTION

Crude oil prices in Indonesia encountered a downturn since 2015. Although Indonesian government raised the price of Premium gasoline on 18 November 2014 to IDR 8,500 per liter, the price of Premium gasoline decreased by 11.8% to IDR 7.600 per liter on



January 1, 2015. Changes in the price of Premium gasoline continued until the last changed to IDR 6.550 per liter on April 1, 2016.

The decline in oil prices is not only happen to oil prices in Indonesia, but also world oil prices. The benchmarks for the light crude oil group is West Texas Intermediate (WTI) in North America and Brent crude in Europe and Africa. West Texas Intermediate and Brent is the most used benchmarks for crude oil prices marker in the world market (Hammoudeh et al., 2008). At the end of 2014 the price of Brent crude and West Texas Intermediate, both of which are an international benchmark, has fallen by more than 45 percent from last year's prices.

Market price of crude oil fluctuations is determined by the mechanism of demand and supply as the fundamental factors (Nizar, 2012). On the demand side, economic growth affects the price of oil. World economic growth conditions affect oil prices in the international market in recent years. The global economy is in decline. Europe and Japan have not recovered from the previous economic crisis. On the other hand, China is now very careful guarding the weakening of economic growth, which amounted to 7.1% in 2015, 7% in 2016 and 6.9% in 2017 (World Bank, 2015). This makes the demand of the world's oil decreases causing oil prices downturn.

From the supply side, crude oil price fluctuation is strongly influenced by the availability or oil supplied by producer countries. Availability or supply of oil is closely associated with the production capacity, investment, and refinery infrastructure capacity (Kesicki, 2009). The condition of the world oil supply is currently in oversupply condition. Oil production in the United States have increased almost two-fold in the past few years. This made oil importers such as Arab, Nigeria, and Algeria had to find new markets in Asia. Similarly, Canada and Iraq continued to increase oil production. OPEC as an organization that is supposed to regulate the price and production of oil company refused to cut oil production that could raise world oil prices. Countries like Saudi and allies refuse to cut oil production. Meanwhile, Iran has just lifted the economic sanctions, continued to increase its oil production (Krauss, 2016).

The world oil prices downturn has an impact on the world's oil and gas companies financial health. According to a report released by Deloitte (2016) entitled "The crude



downturn for exploration & production companies", as much as 35% of oil and gas companies around the world or as many as 175 companies categorized in high-risk quadrant with the determining factor is the high leverage ratio and low debt service coverage. These companies have stockpiled a total debt of more than \$ 150 billion on their balance sheet. 50 of the 175 companies that have negative equity or leverage ratio above 100. Most likely these companies will be bankrupt by 2016, unless oil prices recover.

Stock price index is an indicator or reflection of changes in stock price. The movement of stock prices is an indicator of investor interest in investing. According to a report released Colonial First State (2015), entitled "The impact of lower oil prices on the Australian equities", oil prices downturn caused energy sector index S&P/ASX 200 declined value of nearly 18% in the December quarter 2015. In Indonesia Stock Exchange price index of mining stocks also declined. Changes in world oil prices has positive effect on the entire sector in the Indonesia Stock Exchange (Rahmanto et al., 2016). According to data compiled from Yahoo Finance, during 2015 the mining sector in particular has decreased the most, namely by 40%. The same thing happened in the Singapore Exchange, the FTSE ST Oil & Gas has declined by 34.3% during 2015. This situation is an indication that the interest of investors to invest in oil and gas company in Indonesia, Australia and Singapore has declined. World oil prices downturn resulted some oil and gas companies are experiencing financial difficulties and in danger of bankruptcy. This makes investing in oil and gas companies can be very costly.

Most companies go public in order to obtain alternative financing or funding sources. Investors will assess the company before deciding to invest. One way is by analyzing the ratings company information contained in the financial statements that reflect the company's performance and financial condition. Analysis reports aim to provide data needed to make investment decisions. The investment decision such as the decision to buy, sell, or retain ownership of a company. The market will respond to the fluctuations in the stock price of the company, if the company's financial condition and performance is good, then the company's stock price will also go up. Therefore, predictions and analysis of financial statements is essential not only for companies but also for stakeholders (Hadi and Anggraeni, 2010).



One form of the company's financial statements analysis is to predict its bankruptcy. At the time of oil prices downturn is the right time to analyze bankruptcy prediction on oil and gas companies. There are several models of bankruptcy prediction, one bankruptcy prediction method is by counting and classifying firms with Altman Z-Score. Altman is the first researcher to apply Multiple Discriminant Analysis for the analysis of bankruptcy. Altman Z-Score is generated by summing the results of multiplying a certain constant value each with 5 elements in the ratio of manufacturing companies. Based on the Z-score, companies are grouped into 3 groups: bankrupt, gray area, and financial healthy. Companies that categorized into bankruptcy is predicted to suffer financial distress within one or two year. For companies that fall within the gray area is predicted to have the possibility to go bankrupt but can still be saved if cautiously managed and take the right decision. Meanwhile, if the company categorized as financial healthy is predicted that the company will not experiencing financial distress. Based on the exposure to the above authors are interested in examining the relationship between world oil prices of Brent on the probability of bankruptcy. This study aims to determine the extent of world oil prices of Brent can affect the probability of bankruptcy directly.

HYPOTHESIS DEVELOPMENT

The main objective of financial reporting is to provide relevant information to each user of financial statements both internal and external parties regarding the financial position, financial performance, and cash flows of the entity for making economic decisions. Users of financial statements may use the information contained in the financial statements in a straightforward manner using facts and data contained in the financial statements or to reprocess the data which is attached to the financial statements by analyzed the data according to the intent and purpose. Analysis of the financial statements is to use financial statements as the subject of the application of analytical tools and techniques to make the information less and see its relationship with the aim to determine the financial conditions, and can generate a more informed decision.

Financial statement analysis can help investors in making investment decisions. The investment decision in question is the decision to buy, sell, or retain ownership. Positive



earnings in large numbers reflect conditions established companies that can afford to pay high dividends. The market will respond to the fluctuations in the stock price of the company, if the company's financial condition and performance is good, then the company's stock price will also go up (Susanto and Ekawati 2006). The company also requires analysis of financial reports to know information about the condition and position of the company in more depth. This information can be useful for companies to plan, conduct, and assess the activity of the company in order to operate more effectively and efficiently. When companies operate more effectively and efficiently than its competitors it will make the company have the competitive advantage that makes the company gain an advantage over its competitors.

In the midst of world oil prices downturn, the biggest fear for stakeholders in the oil and gas company is the financial health of the company. The threat of bankruptcy due to low selling prices led the management and investors to be more cautious in making decisions. One way of predicting bankruptcy is by analyzing the information contained in the financial statements. Prediction bankruptcy Altman's Z-score is one of the models for predicting bankruptcy in manufacturing, non-manufacturing company, and the private company years prior to the bankruptcy. Z-score as a bankruptcy prediction model first using Multiple Discriminant Analysis (MDA) has a level of accuracy that is quite high at 94 percent. Z-score is calculated based on the ratio 5 is the working capital to total assets, retained earnings to total assets, earnings before interest and taxes to total assets, and market value of equity to total liabilities, and sales and total assets.

The X_1 ratio or Working capital to total assets show the level of liquidity by comparing working capital to total assets. working capital is calculated from the difference between current assets by current liabilities. The higher the value of the ratio of working capital to total assets, the less likely the company went bankrupt. The X_2 ratio or the Retained earnings to total assets measure the cumulative profitability of the company from time to time. This ratio also describe the age of the company because the younger the company tend to have the lower ratio. The higher the value of the ratio of retained earnings to total assets, the less likely the company went bankrupt. The X_3 ratio or Earnings before interest and taxes to total assets measure the level of productivity of the company's assets. This ratio is considered proper for studies related to financial distress because of the continuity of the



company's operations are based productivity levels of its assets. The higher the value of the ratio of earnings before interest and taxes to total assets, the less likely the company went bankrupt. The X_4 ratio or Market value Book value of equity to total debt capital market value compares with the amount of debt. Companies are considered to have failed generally have a small ratio for having more debt than their own capital. The higher the value of the ratio of market value of equity to book value of total debt, the less likely the company experienced kebangkrutan. The X_5 ratio or Sales to Total Assets show the ability of the company's assets in generating sales. This ratio is generated by dividing the number of sales by total assets. This ratio is less effective when comparing company with different business sectors.

This study aims to determine whether there is influence of bankruptcy prediction model Altman Z-score on oil and gas companies listed on IDX, ASX and SGX. Thus the hypothesis of this study is

H1: The decline in the price of Brent crude has an influence on the probability of bankruptcy on the company's oil and gas sector.

RESEARCH METHOD

Population and Sample

This study examined 20 companies oil and gas company in Indonesia, Singapore, and Australia in 2013-2015. The sampling method in this research is purposive sampling.

The criteria used in the selection of the sample is (1) Companies that have a primary business activity in the oil and gas sector; (2) Listed in Indonesia Stock Exchange (IDX), Australian Securities Exchange (ASX) and Singapore Exchange (SGX) in the period 2013-2015 with a complete financial data; (3) Prepare financial statements to the date of the financial ended December 31; (4) Perform production activities (refinery). After elimination obtained 20 companies that meet the criteria.



Variable Operationalization

Dependent Variable

The dependent variable (Y) is the variable that is affected or which become due for their independent variable. The dependent in this research is the Z-Score resulting from the calculation 5 financial ratios namely X_1 (Working Capital / Total Assets) for measuring the liquidity of the company, X_2 (Retained Earnings / Total Assets) to measure the ability of cumulative profit companies, X_3 (Earning Before interest and Tax / Total Assets), and X_4 (Market Value of Equity / Book Value of Debt) and X_5 (Sales / Total Assets) were calculated from the financial statements of companies oil and gas listed on the Indonesia Stock Exchange (IDX), Australia Securities Exchange (ASX) and Singapore Exchange (SGX). Formula for Z-score is:

$$Z = 1.2X_1 + 1.47X_2 + 3.3X_3 + 0.6X_4 + 1.0X_5$$

Independent Variable

The independent variable (X) are variables that affect the dependent variable. Variables used in this research is the market price of Brent oil. The market price of Brent crude is used as the benchmark prices on the world oil market. In addition to Brent crude, West Texas Intermediate crude is also commonly used as a benchmark in world oil prices. Benchmarks for the light crude oil group is West Texas Intermediate (WTI) in North America and Brent crude in Europe and Africa. West Texas Intermediate and Brent is the most famous oil prices marker for crude oil in the world market (Hammoudeh et al., 2008).

At this time of Brent crude is more widely used as a benchmark, because it is used not only in Europe but also a benchmark in the area of West Africa and the Mediterranean. Even the price of oil in Southeast Asia had already started to follow the benchmark oil price Brent (Nunan, 2012). Brent crude oil has more influence on world oil prices globally compared to WTI. This makes the price of Brent crude oil is the best indicator of world oil prices.



Data Analysis Method

To test the hypothesis developed in this study, this research used regression analysis with the help of IBM SPSS Statistics software. There are three models of the regression equation which will be tested in this study, namely Indonesia regression model, the regression model Australia, and Singapore regression model. The regression equation used in this study are as follows:

$$PK = \alpha + \beta_1 HM_{it} + e$$

Information:

PK = Probability of Bankruptcy

HM = Oil Prices

α = Constant

β_1 = Regression Coefficient

e = Error

RESULTS

Descriptive Statistics Analysis

Table 1. Descriptive Statistics Analysis

Indonesia				
Tahun	Rata-Rata	Standar Deviasi	Minimum	Maksimum
2013	2.690	2.392	0.749	7.330
2014	2.719	2.185	0.608	6.412
2015	1.610	1.254	-0.103	2.779
Australia				
Tahun	Rata-Rata	Standar Deviasi	Minimum	Maksimum
2013	1.819	1.768	0.101	5.788
2014	1.251	1.636	-0.629	4.030
2015	0.219	1.227	-1.186	1.959
Singapura				
Tahun	Rata-Rata	Standar Deviasi	Minimum	Maksimum
2013	2.252	0.645	1.562	3.222
2014	1.513	0.904	0.349	2.871
2015	1.313	0.875	-0.105	2.116



In table 1, we can see the comparison value of Z-score on the state of Indonesia, Australia, and Singapore. In 2013, 2014 and 2015, countries that have a Z-score highest on average is Indonesia. While Australia is the lowest average Z-Score value. It can be seen that most of the companies in the three countries experienced a decline in the value of Z-score in the period June 2013 to December 2015. 16 of the 20 companies has Z-Score decreased with the most downturn is Nido Petroleum (NDO) with a decrease of -198.06%. However, 4 of the 20 companies has increased Z-score in the period June 2013 to December 2015. The company is Ratu Prabu Energi (ARTI), Radiant Utama Intersco (Ruis), Keppel Corp (BN4), and Swiber (BGK) with Swiber (BGK) as a company that is has the highest increase of 99.54%. Nevertheless, that does not mean companies are not affected by the drop in oil. The increase in the value of Z-score occurred in the second semester of 2015 after declining in the first semester of 2015.

From June 2013 until December 2015 the value of Z-score companies do not always declined. Only three companies which decreased continuously from June 2013 until December 2015, such as Incremental Oil Gas (IOG), Tap Oil Limited (TAP), and Kris Energy Ltd (SK3). While another company in Indonesia, Singapore, and Australia Z-score experienced rises and falls in the period June 2013 to December 2015

The decline in world oil prices began in mid 2014. However, the effects of the decline in oil prices affect in the early half of 2015. It can be seen from a Z-score of companies in the first semester of 2015 when compared with the value of Z-score the second semester of 2014, 18 the company experienced a significant decline, while the two remaining are Santos Ltd. (STO) and Keppel Corp (BN4) experienced an insignificant increase or steady.

The Company is expected to bankrupt one to two years if the value of the Z-Score was under 1.81. While the company considered financially healthy when a Z-Score is above 2.99. Companies that have a Z-Score values between 1.81 and 2.99 is believed to have a healthy financial condition but has the probability to go bankrupt if wrongly managed.

In 2013, there were 10 of the 20 companies that have a Z-Score below 1.81, or in other words to be predicted bankrupt within one to two years. In 2014, the number of companies that have a value below 1.81 Z-Score increased to 11 from 20 companies. By



2015 the number of companies that have a Z-Score below 1.81 again increased to 14 from 20 companies.

In table 1 we can see the comparison value of Z-score on the state of Indonesia, Australia, and Singapore. In 2013, 2014 and 2015, countries that have a Z-score highest on average is Indonesia. While having the average value of the lowest is the country Australia. It can be seen that most of the companies in the three countries experienced a decline in the value of Z-score in the period June 2013 to December 2015. 16 of the 20 companies has decreased with the most is Nido Petroleum (NDO) with a decrease of -198.06%. However, four of the 20 companies has increased Z-score in the period June 2013 to December 2015. The company is Ratu Prabu Energi (ARTI), Radiant Utama Intersco (Ruis), Keppel Corp (BN4), and Swiber (BGK) with Swiber (BGK) as a company that is experiencing the highest increase of 99.54%. Nevertheless that does not mean companies are not affected by the drop in oil. The increase in the value of Z-score occurred in the second semester of 2015 after declining in the first semester of 2015.

From June 2013 until December 2015 the value of Z-score companies do not continue to decline. Only three companies which decreased continuously from June 2013 until December 2015, namely Incremental Oil Gas (IOG), Tap Oil Limited (TAP), and Kris Energy Ltd (SK3). While Z-score another company in Indonesia, Singapore, and Australia experienced rises and falls in the period June 2013 to December 2015.

The decline in world oil prices began in mid 2014. However, the effects of the decline in oil prices affect in the early half of 2015. It can be seen from a Z-score of companies in the first semester of 2015 when compared with the value of Z-score the second semester of 2014, 18 the company experienced a significant decline, while the two remaining are Santos Ltd. (STO) and Keppel Corp (BN4) experienced an insignificant increase or steady.

The Company is expected to bankrupt one to two years if the value of the Z-Score was under 1.81. While the company considered financially healthy when a Z-Score is above 2.99. Companies that have a Z-Score values between 1.81 and 2.99 is believed to have a healthy financial condition but has the probability to go bankrupt if wrongly managed.

In 2013, there were 10 of the 20 companies that have a Z-Score below 1.81, or in other words to be predicted bankrupt within one to two years. In 2014, the number of



companies that have a value below 1.81 Z-Score increased to 11 from 20 companies. By 2015 the number of companies that have a Z-Score below 1.81 again increased to 14 from 20 companies.

It show that the predicted outcome from Z-score calculation that 10 out of 20 companies will be bankrupt within a period of one to two years. But it proved to be inaccurate because of the 10 companies are still in operation until 2015. There is some evidence suggesting why a Z-score failed to predict the bankruptcy is because these companies are multinational companies that have lines of business outside of the oil sector and the companies supported by the parent company has a strong financial condition or an enterprise supported by the state. In addition anomaly of years studied and the limited sample of data used can also be a cause disruption of the value of Z-score.

Classical Assumption Test

Test for normality in this study using the Kolmogorov-Smirnov (K-S). If the significance value is greater than 0.05, it can be concluded that the residual in the regression model are normally distributed. The test results of the all three regression models Indonesia, Australia, and Singapore showed that the residue in the regression model are normally distributed, namely 0056, 0569, 0296. In other words, the regression model of the three countries are eligible to use because it has meet the assumptions of normality of data.

Multicollinearity test was conducted using the Run Test. Data can be said autocorrelation free, if the significance value greater than 0.05. The test results showed that the significance of each country that is 0.398 for Indonesia model, 0.109 for Australia model, and 0.063 for Singapore model. The results of the third Test Run these countries have a value above 0.05. It can be concluded that the residual value of the three models is random or no autocorrelation between residual value.

Heteroscedasticity test aims to test whether the regression model occurred inequality residual variance from one observation to another observation (Ghozali, 2013). Based on the scatterplot graph, there is no clear pattern, and dots spread randomly above and below the number 0 on the Y axis on the third regression model. These results indicate that all three models freed from their studies and have qualified heteroscedasticity regression analysis.



Hypothesis Test

Table 2. t Test Result

Model	Unstandardized		Standardized	T	Sig.
	Coefficients		Coefficients		
	B	Std. Error	Beta		
1 (Constant)	-.639	.957		-.688	.509
Indonesia	.036	.011	.488	3.263	.003
2 (Constant)	-.629	.596		-1.056	.296
Australia	.022	.007	.424	3.178	.003
3 (Constant)	.313	.340		.922	.363
Singapura	.015	.004	.553	3.873	.000

This research was conducted with a significance level (α) of 0.05 or 5%. From the table above, note that the t_{count} value obtained models Indonesia amounted to 3.263. This value will be compared with the value of the t_{table} on the t distribution table. With $\alpha = 0.05$, $df = 34$ ($36-1-1$), for two-tailed test values obtained $t_{\text{table}} \pm 2.032$. From these values seen that t_{count} obtained amounted to 3.263, are outside t_{table} value (-2.032 and 2.032). In accordance with the criteria of testing the hypothesis that H_0 and H_1 accepted, meaning the price of oil significantly influence the probability of bankruptcy on the model of Indonesia.

From the table above, note that the t_{count} value obtained by the Australian model is 3.178. This value will be compared with the value of the t_{table} on the t distribution table. With $\alpha = 0.05$, $df = 46$ ($48-1-1$), for two-tailed test values obtained $t_{\text{table}} \pm 2.013$. From these values seen that t_{count} obtained at 3,178, are outside t_{table} value (-2.013 and 2.013). In



accordance with the criteria of testing the hypothesis that H_0 and H_1 accepted, meaning the price of oil significantly influence the probability of bankruptcy on the Australian model.

From the table above, note that the t_{count} value obtained is equal to 3,874 Singapore model. This value will be compared with the value of the t_{table} on the t distribution table. With $\alpha = 0.05$, $df = 34$ ($36-1-1$), for two-tailed test values obtained $t_{\text{table}} \pm 2.032$. From these values seen that t_{count} obtained at 3,874, are outside t_{table} value (-2.032 and 2.032). In accordance with the criteria of testing the hypothesis that H_0 and H_1 accepted, meaning the price of oil significantly influence the probability of bankruptcy on the Singapore model.

Analysis Coefficient of Determination

Table 3. Coefficient of Determination

Model	R	R Square	Adjusted R Square	Std. Error of the Estimate
Indonesia	.488 ^a	.238	.216	1.95189
Australia	.424 ^a	.180	.162	1.40374
Singapura	.553 ^a	.306	.286	.69285

The coefficient of determination (R^2) aims to measure how far the ability of the model to explain variations in the dependent variable. The coefficient of determination is between zero and one. A small (R^2) value means that the ability of the independent variables in explaining the variation of the dependent variable is very limited. According to the table above, shows that the coefficient of determination is 21.6% for Indonesian model. This shows that the price of oil contributed to the probability of bankruptcy in Indonesia amounted to 21.6%, while the remaining 78.4% is the contribution of other variables not examined. Australian model obtained determination coefficient of 16.2%. This shows that the price of oil contributed to the probability of bankruptcy by 16.2%, while the remaining 83.8% is the contribution of other variables not examined. While the value of the coefficient of determination Singapore model is 28.6%. This shows that the price of oil contributed to the bankruptcy probability of 28.6%, while the remaining 71.4% is the contribution of other variables not examined

CONCLUSION AND IMPLICATION

Based on the results of data analysis and implication, can be obtained several conclusions. Oil prices affect the probability of the three countries studied. The price of oil in Indonesia has a significant influence on the probability of bankruptcy with the contribution of 21.6% for Indonesian model. This shows that the price of oil contributed to the probability of bankruptcy in Indonesia amounted to 21.6%, while the remaining 78.4% is the contribution of other variables not examined. Oil prices in Australia have a significant effect on the probability of bankruptcy with the contribution of 16.2%. This shows that the price of oil contributed to the probability of bankruptcy by 16.2%, while the remaining 83.8% is the contribution of other variables not examined. Oil prices in Singapore have a significant effect on the probability of bankruptcy with the contribution of 28.6%. This shows that the price of oil contributed to the bankruptcy probability of 28.6%, while the remaining 71.4% is the contribution of other variables not examined.

Variable oil price in the country of Indonesia, Singapore, and Australia showed a positive and significant effect on the probability of bankruptcy. The results of this study indicate that the increase in world oil prices of Brent will increase company's Z-Score. The lower the price of oil will decrease the sales of oil and gas companies. With production costs remain the same make profit of the company go down. It is also impacted by the decline of interest in investment in oil and gas that can be seen from the decline in stock prices.

There are 10 of the 20 oil and gas company in Indonesia, Australia and Singapore, which have a Z-Score below 1.81, or in other words to be predicted bankrupt within one to two years. In 2014, the number of companies that have a value below 1.81 Z-Score increased to 11 from 20 companies. By 2015 the number of companies that have a Z-Score below 1.81 again increased to 14 from 20 companies.

Suggestions for future research could examine the effect of oil prices on the entire corporate sector. Moreover, future research can add another independent variables, control variables, or mediating variables to determine other variables that affect the probability of bankruptcy. Researchers can also use other bankruptcy prediction models such as Springate, Zmijewski, or CA-Score.



REFERENCES

- Adrian, A., & Khoiruddin, M. (2014). Pengaruh Analisis Kebangkrutan Model Altman Terhadap Harga Saham Perusahaan Manufaktur. *Management Analysis Journal*, 3(1).
- Altman, E. I. (1968). Financial ratios, discriminant analysis and the prediction of corporate bankruptcy. *The Journal of Finance*, 23(4), 589–609.
- Altman, E. I., & others. (2000). Predicting financial distress of companies: revisiting the Z-score and ZETA models. *Stern School of Business, New York University*, 9–12.
- Apergis, N., Sorros, J., Artikis, P., Zisis, V., & others. (2011). Bankruptcy probability and stock prices: the effect of Altman Z-score information on stock prices through panel data. *Journal of Modern Accounting and Auditing*, 7(7), 689.
- Astikasari, Y. (2012). Analisis Pengaruh Altman Z-Score dan Economic Value Added (EVA) terhadap Return Saham Perusahaan-Perusahaan yang Bergerak pada Sektor Properti di Bursa Efek Indonesia. *Jurnal Ilmiah Universitas Bakrie*, 1(01).
- Black, H. C., Garner, B. A., & McDaniel, B. R. (1999). *Black's law dictionary* (Vol. 196). St. Paul, MN: West Group.
- Brigham, E., & Houston, J. (2011). *Fundamentals of financial management*. Cengage Learning.
- Chang, Y., & Wong, J. F. (2003). *Oil price fluctuations and Singapore economy*. *Energy policy*, 31(11), 1151-1165.
- Colonial First State. (2015). *The impact of lower oil prices on Australian equities*. Retrieved from <http://www3.colonialfirststate.com.au/content/dam/wm/advisers/investments/docs/FS6219.pdf>
- Deloitte. (2016). *The crude downturn for exploration & production companies*. Deloitte Center for Energy Solutions. Retrieved from <http://www2.deloitte.com/us/en/pages/energy-and-resources/articles/the-crude-downturn-for-exploration-and-production-companies.html>
- Duta, D. K. (2015). BP Indonesia Kesulitan Modal untuk Eksekusi Blok Tangguh. *CNN Indonesia*. Retrieved from <http://www.cnnindonesia.com/ekonomi/20150410152006-85-45725/bp-indonesia-kesulitan-modal-untuk-eksekusi-blok-tangguh/>



- Fahmi, I. (2011). Analisis Laporan Keuangan. *Lampulo: ALFABETA*.
- Ghozali, I. (2011). Analisis Multivariate Program IBM SPSS 19. *Semarang: Badan Penerbit Universitas Diponegoro*.
- Hadi, S., & Anggraeni, A. (2008). Pemilihan Prediktor Delisting Terbaik (Perbandingan Antara The Zmijewski Model, The Altman Model, dan The Springate Model). *Jurnal Akuntansi & Auditing Indonesia*, 12(2).
- Hanafi, M. M., & Halim, A. (2003). *Analisis Laporan Keuangan*. AMP-YKPN, Yogyakarta.
- Hammoudeh, S. M., Ewing, B. T., & Thompson, M. A. (2008). Threshold cointegration analysis of crude oil benchmarks. *The Energy Journal*, 79-95.
- Harahap, S. S. (2009). Analisa kritis atas laporan keuangan. *Jakarta: RajaGrafindo Persada*.
- Husnan, S. (2006). Dasar-dasar Manajemen Keuangan, edisi kelima. *Yogyakarta*.
- Irawati, Susana. 2006. *Manajemen Keuangan*. Edisi Pertama. Bandung: PT.Pustaka.
- Kamaludin., & Indriani, R. (2012). Manajemen Keuangan: Konsep Dasar dan Penerapannya, edisi revisi. *Bandung: Mandar Maju*.
- Kasmir. (2000). Manajemen Perbankan. *Jakarta: PT RajaGrafindo Persada*.
- Keown, A. J., Martin, J. D., Petty, J. W., & Scott, D. F. (2004). Manajemen Keuangan: prinsip-prinsip dan aplikasi. *Edisi kesembilan*. Jakarta: PT. Indeks Kelompok Gramedia.
- Kesicki, F. (2010). The third oil price surge – What’s different this time? *Energy Policy*, 38(3), 1596–1606. <http://doi.org/10.1016/j.enpol.2009.11.044>
- Krauss, Clifford. (2016). Oil Prices Explained: Signs of a Modest Revival. *The New York Times*. Retrieved from <http://www.nytimes.com/interactive/2016/business/energy-environment/oil-prices.html>
- Nizar, M. A. (2012). Dampak Fluktuasi Harga Minyak Dunia Terhadap Perekonomian Indonesia. *Buletin Ilmiah Litbang Perdagangan*, 6(2). Retrieved from <http://fiskal.depkeu.go.id/2010/adoku/2014kajianpkemCDampakFluktuasiHargaMinyakDunia.pdf>
- Nunan, Anthony. (2012). Brent Favored Over WTI Oil by U.S. for First Time. *Bloomberg*. Retrieved from <http://www.bloomberg.com/news/articles/2012-12-06/brent-favored-over-wti-by-u-s-for-first-time-as-prices-diverge>



- Peter., & Yoseph. (2011). Analisis Kebangkrutan Dengan Metode Z-score Altman, Springate dan Zmijewski Pada PT. Indofood Sukses Makmur Tbk Periode 2005-2009. *Akurat Jurnal Ilmiah Akuntansi*, 4(2).
- Prihadi, T. (2012). Analisis Laporan Keuangan Lanjutan Proyeksi dan Valuasi. *Jakarta: PPM*.
- Rahmanto, F., Riga, M. H., & Indriana, V. (2016). The Effects of Crude Oil Price Changes on the Indonesian Stock Market: A Sector Investigation. *INDONESIAN CAPITAL MARKET REVIEW*, 8(1), 12–22.
- Sondakh, J., Pontoh, W., & Tangkuman, S. (2014). Pengaruh Rasio Keuangan Atas Return Saham Pada Perusahaan Industri Manufaktur Di Bursa Efek Indonesia. *JURNAL LPPM BIDANG EKOSOSBUDKUM*, 1(1), 65–79.
- Sugiyono, D. (2010). *Metode penelitian kuantitatif kualitatif dan R&D*. Bandung : Penerbit Alfabeta.
- Sukmawati, N. M. D., Adiputra, I. M. P., Darmawan, N. A. S. (2014). Pengaruh Rasio-Rasio Dalam Model Altman Z-Score Terhadap Harga Saha, (Studi Pada Perusahaan Perbankan yang Go Public di Bursa Efek Indonesia). *JIMAT (Jurnal Ilmiah Mahasiswa Akuntansi SI)*, 2(1). Retrieved from <http://ejournal.undiksha.ac.id/index.php/S1ak/article/view/3397>
- Supardi dan Sri Mastuti. 2003. *Validitas Penggunaan Z-Score Altman Untuk Menilai Kebangkrutan Pada Perusahaan Perbankan Go Publik di Bursa Efek Jakarta*. Dalam *Kompak* No. 7. Januari-April, 10.
- Susilawati, C. D. K. (2014). Pengaruh Rasio Keuangan Terhadap Harga Saham Pada Perusahaan Manufaktur. *Jurnal Ilmiah Akuntansi*, 4(2), 57-75.
- Taufiza, I. (2015). Harga Minyak Dunia Turun, Perusahaan Migas Ambil Langkah Ini. *Tempo*. Retrieved from <https://m.tempo.co/read/news/2015/09/29/090704775/harga-minyak-dunia-turun-perusahaan-migas-ambil-langkah-ini>
- Ulber, S. (2009). *Metode penelitian sosial*. Bandung : PT. Rafika Aditama.
- Wagiri, W. A. (2013). Pengaruh Dividend Yield, B/M (Book to Market) dan Earning Yield Terhadap Harga Saham Perusahaan Pada Sektor Aneka Industri Periode 2007-20011. *CALYPTRA: Jurnal Ilmiah Mahasiswa Universitas Surabaya*, 2(1).



- Widarjo, W., & Setiawan, D. (2009). Pengaruh Rasio Keuangan Terhadap Kondisi *Financial Distress* Perusahaan Otomotif. *Jurnal Bisnis dan Akuntansi*, 11(2), 107-119.
- Wild, J. J., Subramanyam, K. R., & Halsey, R. F. (2005). *Analisis Laporan Keuangan*. Jakarta: Salemba Empat.
- Witjaksono, A. A. (2010). *Analisis Pengaruh Tingkat Suku Bunga SBI, Harga Minyak Dunia, Harga Emas Dunia, Kurs Rupiah, Indeks Nikkei 225, dan Indeks Dow Jones terhadap IHSG (studi kasus pada IHSG di BEI selama periode 2000-2009)* *Jurnal Bisnis dan Akuntansi*, 10(2), 81-90.
- The World Bank. (2015). Bank Dunia: Prospek Ekonomi Global Membaik pada 2015, Namun Masih Berisiko. *The World Bank Press Release*. Retrieved from <http://www.worldbank.org/in/news/press-release/2015/01/13/global-economic-prospects-improve-2015-divergent-trends-pose-downside-risk>



**PREDICTING GREEN PURCHASE INTENTION OF GENERATION Y: AN
EMPIRICAL STUDY IN INDONESIA**

Sheila F. Eles

chell.princeton@gmail.com

Sabrina O. Sihombing⁴

Universitas Pelita Harapan

sabrina.sihombing@uph.edu

Abstract

Environmental awareness is growing up as the environmental issues nowadays are significant to human lives. Some manufacturers started to entering green product market and targeting green consumers. Many studies have been conducted to examine the influence of several factors such as environmental knowledge, environmental concern, attitudes, and price on green purchase intention. However, just few studies stated that price also influenced the decision-making on buying green products specifically in the context of Indonesian. Whereas price become one of the most important factors considered by consumers. This study investigated the relationship of environmental knowledge, environmental concern, subjective norms, price fairness, attitudes, and green purchase intention. The research model was tested by using self-administrated questionnaires of 200 students in private university. Before the questionnaires were distributed, the pilot study was conducted to assess the reliability and validity of the instruments. The hypotheses were measured by Structural Equation Model (SEM). The result showed that there were three hypotheses which were supported and two unsupported hypotheses. This research gives recommendations for future research.

Keywords: *environmental knowledge, green products, environmental concern, subjective norms, price fairness, attitudes, green purchase intention*

JEL Classification: *Q56*

⁴ Corresponding Author



INTRODUCTION

Environmental issues globally become an important aspect in human life as everyone starts concerning about the issues. In recent years, market place turns out into more environment-friendly rather than foretime (Ansar, 2013). Businesses are trying to attract market with the concept of green marketing. The technology has been developed to enable them entering the potential market regarding current global issues. The growing issues bring the broad impact to all fields. Eco-friendly products considered as an opportunity to enter wide range of market and being developed in many aspects (Ishaswini & Datta, 2011; Coleman *et al.*, 2011).

The trends of organic food, eco-friendly electronics or products, recyclable packaging, and even safe-materials-cosmetics are already spread out. Body Shop is one of the manufacturers that concern about using materials derived from nature and focusing on how the environmental damage can be minimized (Ling, 2013; Teng, 2011). The issues are not only triggering business and manufacturers, but also consumer itself. Consumers tend to avoid products that are possibly contaminated by unsafe substances. They begin to make environmental consideration for the products they purchased (Karatu & Nik Mat, 2015; Barber *et al.*, 2009). That consideration can be taken from the people around them who had past experience towards the products.

Many studies have been conducted to examine the influence of several factors such as environmental knowledge (Effendi *et al.*, 2015; Karatu & Mat, 2015; Ali & Ahmad, 2012; Noor *et al.*, 2012; Saleki *et al.*, 2012; Gracia *et al.*, 2010; Magistris & Gracia, 2008; Mostafa, 2007); environmental concern (Irianto, 2015; Karatu & Mat, 2015; Suki, 2013; Ali & Ahmad, 2012; Salleh, *et al.*, 2010; Ishaswini & Datta, 2011); attitudes (Effendi *et al.*, 2015; Irianto, 2015; Anvar & Venter, 2014; Terenggana *et al.*, 2013; Mahesh, 2013; Suprpto & Wijaya, 2012; Chen & Chai, 2010); subjective norms (Effendi *et al.*, 2015; Irianto, 2015; Tarkiainen & Sundqvist, 2005); and price (Irianto, 2015; Karatu & Mat, 2015; Suki, 2013; Ling, 2013; Sangkumchaliang & Huang, 2012; D'Souza *et al.*, 2007; Hansla *et al.*, 2008) on green purchase intention, however, just few studies stated that price also influenced the decision-making on buying green products specifically in the context of Indonesian (Effendi *et al.*, 2015; Irianto, 2015). Whereas price become one of the most important factors considered by



consumers. Some of the recent studies just included price as complementary variables below other variables and the role of price fairness has been ignored since it is lack of empirical evidence. Furthermore, mostly previous research which also include subjective norms, were following The Theory of Planned Behavior, where subjective norms affected purchase intention. On the other hand, some research found that subjective norms could affect attitude as well (Irianto, 2015; Saleki *et al.*, 2012; Han *et al.*, 2010; Aertsens *et al.*, 2009; Kim *et al.*, 2009; Chow & Chan, 2008; Tarkiainen & Sundqvist, 2005).

Hence, this study aims to examine the influence of consumers' environmental knowledge, environmental concern, subjective norms, price fairness, and attitudes in purchasing green product. Through this study, price is suggested being another factor that supposed to put into considerations. The literature review section consist related theories and previous studies regarding green purchase intention. The successful section defines the research design and methodologies. Result and discussion of findings are showed next, followed by conclusion and recommendation.

LITERATURE REVIEW

Environmental Knowledge

Environmental knowledge is defined as individual common knowledge of facts, concept, and relationship regarding the natural environment as well as knowledge about an issue effect significantly over decision making process (Zainudin, 2013; Abdul Rashid, 2009). In similar vein, Conraud-Koellner and Rivas-Tovar (2009) defined environmental knowledge as the sets of ecological knowledge that an individuals have of environmental topics. They believe there are three sources knowledge can be derived from: first, ecological ethnocentrism; second, information about environmental issues; third, personal experience and environmental insight.

On the other hand, Wu and Teng (2013) defined green or environmental knowledge as how much the consumer knows about environmental or green issues. A study by D'Souza (2006) indicated how environmental knowledge evolves in two forms. The two forms, thus, concern to the consumer. First, consumers have to be educated to comprehend the common



impact of the environmentally product. Second, consumer's knowledge about the product that definitely produced in an eco-friendly way. Previous study, furthermore, examined that consumers who have knowledge about environmental issues will surely have a higher awareness and potentially present that attitudes toward green products (Aman, 2012). With regard to consumer behavior, the higher the ability of interpreting symbols, means that also higher environmental knowledge itself (Haryanto & Budiman, 2014). Also, knowledge on environmental issues has a tendency to create awareness in brands and likely positive attitudes towards green brands (D'Souza, 2006)

Environmental Concern

Generally, people are surely concerned about environmental issues. There have been several definitions stated by researchers regarding the environmental concern. Lee (2008) is defined environmental concern as the level of emotional complicity in environmental issues. The way consumers express environmental concerns based on product characteristics, exactness of eco-friendly product claims, information given on the products and the advantages (Luchs *et al.* 2010).

Moreover, Alhassan (2007) conceptualized environmental concern as a common attitude that represents the extent to which consumer feels anxious about the environmental condition. Another definition of environmental concern is also purposed by Dunlap and Jones. Dunlap and Jones (2002) then defined environmental concern as the degree to which people are aware to environmental issues and give a contribution to solve those issues. Aside from definition above, Magistris and Gracia (2008) connected the environmental concern with consumers' awareness.

According to Magistris and Gracia (2008), consumers who are more aware on the environmental damage and have a high involvement on environment practices will be more willingly to purchase organic food products. Besides, mostly Western consumers and also other developing countries belong to middle classes; have presented their concern towards environmental issues (Ali *et al.*, 2015). In fact, they have done personal efforts to reduce the impact on the environment.



Subjective Norms

The Theory Reasoned of Action by Fishbein and Ajzen (1975) elaborated that intention is predicted by two factors, the individual's attitudes towards the result of behavior and the point of view of individual's social environment, called as subjective norm. Subjective norms state the beliefs of individuals about how reference groups will regard them if they present a particular behavior (Al-Swidi *et al.*, 2013). In carrying out a purchase, consumers need to seek other resources before deciding to buy, such as information, knowledge, self-confidence and so on (Hasbullah, 2014).

Subsequently, Ajzen (2012) explicates that people can hold normative beliefs through more than one referent individual or group. Generally, based on research, referents are a person's partner, close family and friends, and also likely health professionals or coworkers. That normative beliefs concerning such social referents combine to yield on the whole perceived social pressure or subjective norm. Relatives, friends, colleagues and business partners can intensely influence the individual around them (Han *et al.*, 2010).

Gotschi *et al.* (2007) found that norms learnt at home, bring a significant impact to develop positive attitude. People continuously follow their social norms not simply because they got pressure from social environment. But also, they give information what appropriate behavior should be done (Bamberg *et al.*, 2007). Subjective norms along with attitudes and perceptions of control emerge consistently from the beliefs, no matter how those were formed, by this way beliefs influence intentions and behavior as well (Ajzen, 2014).

Price Fairness

According Kotler and Amstrong (2010) price is the amount of money charged to customers for utilizing or having a product or service. A bunch of customers have a tendency to pay low price because it is more attractive for them (Kaura, 2012). In addition, Kaura (2012) adopted definition from Xia *et al.* (2004) and defined price fairness as the appraisal done by consumers on the price offered whether it is plausible.

Based on D'Souza *et al.* (2007) customers are sensitive toward green product pricing. Sometimes, even the customers have already been familiar with kind of green behavior such as recycling, they are being reluctant to pay more (Hansla *et al.*, 2008) In other words, the



price sensitive green consumers were defined as the customers who are sensitive toward the price range yet practically they realizes the effect of using non-green product to the environment (Ling, 2013).

A study by Samkumchaliang (2012) indicates if a consumer cannot obviously distinguish between organic food and conventional food products, premium price charged can be confusing and influence the purchase decision. It is related to price sensitivity. Price sensitivity is the awareness of consumers about what will they perceived by buying particular products with the costs they paid (Al-Mamun *et al.*, 2014). Higher perceived price presents greater monetary loss for consumers, and leads to lower purchase intention.

Attitude

The previous research carried out by Anic (2010) explains that attitudes are complicated system consisting of the person's conviction and feeling about the object along with a tendency to act towards the object. Attitudes include cognitive, affective and conative aspects, and reflect the way people react to a stimulus. Based on concept, attitudes are divided into two: general and specific attitudes (Sun and Wilson, 2008). Furthermore, attitudes are significant to consumer behavior research and marketing often find ways to ensure and transform attitudes about product, brands, and services (Barber *et al.*, 2009).

On the other hand, attitudes can be defined as continuously likeable or unlikeable evaluation, feelings, and tendencies toward an object or idea (Amstrong & Kotler, 2009). Though attitudes are frequently formed as result of direct contact to the object, attitudes can be formed even without actual experience with specific object (Terenggana, 2013). Subsequently, Chyong *et al.* (2006) identified that attitudes are the most consistent explanatory factor in assessing consumers' willingness to purchase green products.

Apart from the definitions, attitude does reflect what consumers like and dislike (Blackwell *et al.*, 2006). In fact, consumers attitude of reflecting the like or dislike can be possessed from either positive or negative attitude. Rahim (2009) found that consumers will tend to possess positive attitude towards green foods as they consider about their health and environment. Therefore, environmental attitudes frequently become the reason for consumers in product purchasing decisions.



Green Purchase Intention

Meanwhile, a green product refers to a product which specifically nontoxic, recyclable, less pollutant, minimally packaged and contains natural materials (Pavan, 2010; Ottman, 1998). Household equipment's produced with eco-friendly materials, reachable packaging, energy-efficient light bulbs and non-synthetic dyes or perfumes are some of the examples of green products in the market (Mostafa, 2007). Yet, efficient lighting and organic foods is the most renowned green product amongst consumers (Figueiredo & Guillen, 2012).

In case of definition of intention, Ajzen (2005) stated that intention is behavioral inclination until precise time and occasion, and then will be realized in the form of action. Next, the idea of intention is supported by Halim and Hameed (2005). They defined the term of consumer purchase intention as consumer who consider the product in the future and make a repeated purchase and would coming back to their preference. The customers draw up positive purchase intention over a period of time. Consequently, before finally deciding to buy a product, they seek for information and the collective of the desired information, and customers feel more confident about their choice (Rozekhi *et al.*, 2014).

On the other side, green purchase intention is then defined as a concept in which customers purchase eco-friendly products and opt to buy these products rather than other conventional products. Consumers are willing to buy because those products are less harmful for environment (Saeed *et al.*, 2013). In similar vein, Ali and Ahmad (2012) conceptualized green purchase intention as someone's probability and willingness of choosing eco-friendly products as preference over the traditional ones in their purchase considerations.

Green Marketing and Generation Y

The conference of marketing ecology was first taken place in 1975 by The American Marketing Association (AMA). The term of marketing environment well-known as green marketing was introduced in 1980. AMA defined green marketing as ways of marketing products which are considered safe, as the combination of several activities such as product modification, the changes of production process, packaging, advertisement strategic, and the development of marketing fulfillment awareness among industry (Yazdanifard & Mercy, 2011). Recent years, consumers became more aware about how their behavior related to the



environment (Sharaf et al., 2015). Green marketing differs from common marketing. Green marketing not simply focus on social aspect and human life but also the natural aspect (Polonsky, 2011).

As marketing always grows up, the development of green marketing cannot be separated from the role of Generation Y. Generation Y is the batch of people born in the midst of 1980 top 1999 (Crampton & Hodge, 2009). This generation is also known as The Millennial. The whole life of Generation Y is close to the technology. Social media have a strong influence on their buying behavior (Bolton et al., 2013). Generation Y believe that the change of global climate is caused by the human's activities. Therefore, Generation Y has a tendency to purchase green products rather than other consumers (Ottoman, 2011). Green marketing nowadays affected by Generation Y. Green marketing changes the traditional way of marketing to the modern one, which is promotional by social media and internet.

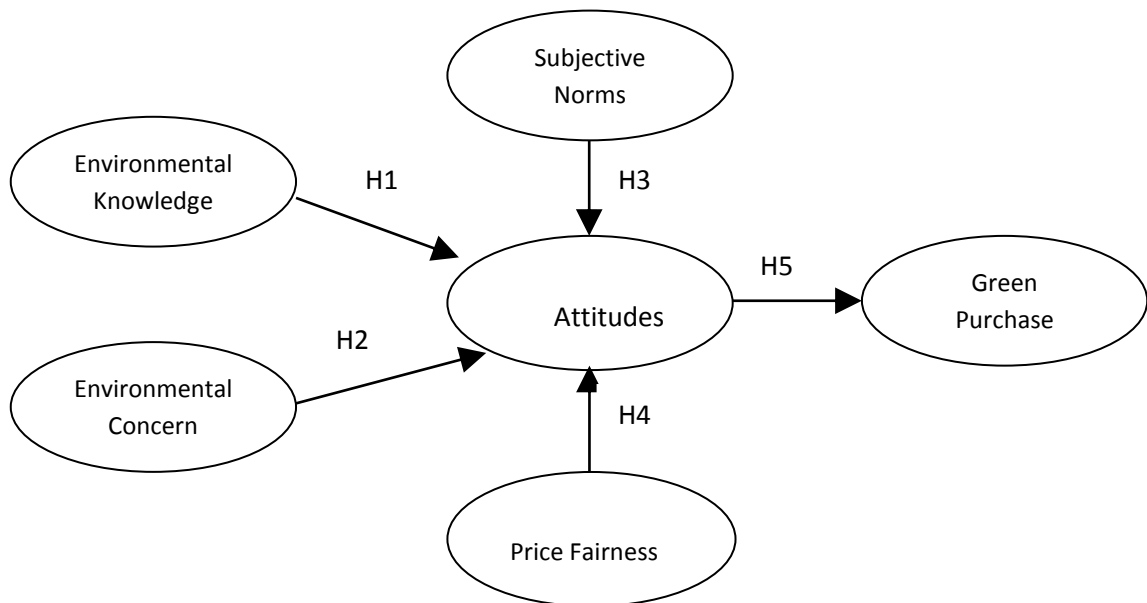

Figure 1. Research Model

Source: developed for this research

HYPOTHESIZED RELATIONSHIP

The Relationship between Environmental Knowledge and Attitude

Knowledge assists to build strong attitudes. Knowledgeable people with strong attitudes are careful and excellence in information (Azila *et al.*, 2012). Banytne *et al.* (2010) made an assumption that the better green consumers obtain the information and the more they find out about the qualities of environmental friendly product, the more they will be motivated to purchase the product. Environmental knowledge tends to build awareness certain products and potential positive attitudes towards green products (D'Souza *et al.*, 2006). The previous studies discovered that environmental knowledge is positively related to attitudes (Akbar *et al.*, 2014; Saleki *et al.*, 2012; Gracia *et al.*, 2010; Magistris & Gracia, 2008; Mustofa, 2006; Tanner & Kast, 2003). Hence, it is hypothesized as:

H₁: *The environmental knowledge is positively related to the attitude*

The Relationship between Environmental Concerns and Attitude

Environmental concerns drive consumer to have attitude towards organic food (Irianto, 2015; Aman *et al.*, 2012; Kim & Chung, 2011; Chen, 2009). According to Lee (2008) environmental concern is the second top predictor influencing consumers' attitude. People with high environmental concerns show the more positive attitude towards the environment (Laskova, 2007). Hence, it is hypothesized as:

H₂: *The environmental concern is positively related to the attitude*

The Relationship between Subjective Norms and Attitude

The research by Tarkiainen and Sundqvist (2005) summed up that subjective norm implicitly impact the intention to buy organic food through attitude. The theory from Ajzen (2014) showed that subjective norms along with attitudes and perceptions of control emerge consistently from the beliefs. Furthermore, when predicting the behavior of an individual, the particular behavior will have close relationship with the reference group (Wu & Chen, 2014). Previous researches show that subjective norms had a direct impact on attitude (Rahab & Wahyuni, 2013; Ibragimova, 2012; Kuang *et al.*, 2012; Mahmood *et al.*, 2011; Teh & Yong,



2011; Teh *et al.*, 2011; Chen *et al.*, 2009; Matos *et al.*, 2007; Lin & Lee, 2004). Hence, it is hypothesized as:

H₃: *The subjective norms has a positive effect on attitude toward green products*

The Relationship between Price Fairness and Green Purchase Intention

Consumers are often being sensitive to premium prices of green products (Bonini & Oppenheim, 2008). They started to make a comparison with conventional ones. People may have favorable attitudes such as recycling and buying green product but willingness to pay more can't be predicted (Anvar, 2014, Hansla *et al.*, 2008). Young *et al.* (2010) identified price as a constraint in purchasing green product. Researcher stated that price reduces the influence of green product attitude. Hence, it is hypothesized as:

H₄: *The price fairness is negatively related to the attitudes*

The Relationship between Attitudes and Green Purchase Intention

The more positive attitudes towards a behavior, the stronger is the intention to bring out such behavior (Ajzen, 1991). Past studies indicate that belief is the good predictor of intention (Sukato & Barry, 2009; Wilson, 2007; Blackwell *et al.*, 2006; Fishbein & Ajzen, 1975) Attitudes, feelings, experiences, and social aspects are the factors affecting beliefs. Those factors must be considered to understand what consumers believe about green marketing and how they may take that belief into action. Previous studies shows the significant relationship between attitude and intention (Rahab & Wahyuni, 2013; Ibragimova *et al.*, 2012; Kuang *et al.*, 2012; Cai and Shannon, 2011; Mahmood *et al.*, 2011; Teh & Yong, 2011; Teh *et al.*, 2011; Zhang, 2011; Bock *et al.*, 2010; Chen *et al.*, 2009; Lin, 2007; Wu & Li, 2007; Lin & Lee, 2004). In the specific, several studies in green products studies show that attitudes are positively related to green purchase intention (Rahim, 2009; Magistris & Gracia, 2008; Mostafa, 2006; Tarkiainen & Sundqvist, 2005). Hence, it is hypothesized as:

H₅: *Attitudes positively related to the green purchase intention*



RESEARCH METHOD

Sample and Data Collection

The respondents of this study are students in a private university. This study was using self-selected non-probability, judgment sample. Therefore, there was a major criteria directed the selection of the respondents, which is those who are using Body Shop products or once used one of the Body Shop products. Data collecting was comprised of two steps. The first step is pilot study to determine whether the instrument could be clearly understood by respondents and also examine the reliability and validity of the instrument. A pilot study conducted to 50 respondents. The second one is the actual research. The research data was obtained through self-administrated questionnaire. It was distributed by giving respondents a time to fill out the questionnaire. Data was collected over three week's period. In total, 200 students in a private university were asked to complete the questionnaire. Sample size used in this study is 200, which is following Hair et al. (2006)

Measures

Environmental Knowledge. This construct was measured by enquiring respondents about general environmental knowledge. The items on the construct were assessed using a five-point Liker-type scale (ranging from 1 = strongly disagree to 5 = strongly agree). Four items scale measuring environmental knowledge was adapted from Chan and Lau (2000) and Kaiser *et al.* (1999). The items used in this construct are as follow: (1) A change in climate caused by increased levels of CO₂ in the atmosphere is called the greenhouse effect, (2) All living beings (micro-organism, plants, animals, and humans) are not interdependent with one another, (3) The most effective way to combat global climate change is to reduce energy consumption, and (4) Most smokes in our big city come from automobiles.

Environmental Concern. Environmental concern was measured through four items as follow: (1) I care about buying environmentally friendly products, (2) It frightens me to think that much of the product I use is contaminated with pesticides, (3) When I purchase products, I try to make efforts to buy products that are low in pollutants, and (4) I make every effort to



reduce the use of plastic bags. Four items in this construct were adapted from Mostafa (2007) and Roberts and Bacon (1997). The items were measured using a five-point Likert-type scale

Subjective Norms. Subjective norms were measured through four items as follow: (1) The trend of buying Body Shop products among people around me is increasing, (2) People around me generally do not believe that it is better for health to use Body Shop products, (3) My close friends and family members would appreciate if I buy Body Shop products, and (4) Many people persuade me that I should buy Body Shop products in order to better lives. The subjective norms scale adapted from Effendi *et al.* (2015) and Al-swidi *et al.* (2013), each assessed by five-point Likert-type scale.

Price Fairness. Price Fairness was measured by asking the respondents about their perceptions toward the price offered. The questionnaire consisted of four items were assessed using a five-point Likert-type scale. Those four items such as follow: (1) The price of Body Shop products in accordance with benefit, (2) The price paid in accordance with the quality of Body Shop products, (3) The price I paid was fair, and (4) The price I paid was not affordable. Four items scale measuring price fairness was adapted from Effendi *et al.* (2015) and Khraim *et al.* (2014).

Attitude. Following the measurement scale by Chen (2009), Laroche *et al.* (2001), and McCarty & Shrum (1994), the attitude consisted of four indicators. The questions related to attitudes towards the particular product. Four indicators are as follow: (1) I like the idea of green products by Body Shop, (2) The idea of Body Shop is a good idea, (3) I have an unfavorable attitude towards Body Shop products, and (4) Recycling will reduce pollution. All indicators were measured on a five-point Likert-type scale anchored from 1 = strongly disagree to 5 = strongly agree.

Green Purchase Intention. This construct was measured by asking respondents about their intentions of green products. Furthermore, green purchase intention was assessed using four-item scale adapted from Chan and Lau (2000) based on a five-point Likert-type scale. The items were as follows: (1) I consider buying Body Shop products because they are less polluting; (2) I intend to buy Body Shop products because they are less polluting, (3) I consider switching to other brands for ecological reasons, and (4) I *don't* intend to switch to other brand for ecological reason.



Data Analysis

Statistical analysis was computed using Statistical Package for Social Sciences (SPSS 22.0). In addition, the hypothesized model of this study (Figure 1) was tested using Structural Equation Model (SEM). In addition, Confirmatory Factor Analysis (CFA) was used to establish the construct validity. For the overall fit of the model, this research used GFI. The calculation used maximum likelihood estimation procedure in order to assess matrix covariant estimation.

RESULT

Description of the sample. A total of 200 questionnaires was distributed and collected from students in a private university. Out of these, 185 samples can be used for further analysis, which is 92.5 per cent usable response rate. The goodness of measures was applied by assessing reliability and validity analysis. Reliability testing was conducted first by using the inter-item consistency measure of Cronbach Alpha. Result shows the coefficients alpha ranged from 0.43 to 0.76. Specifically, there are two variables that have lower Cronbach alpha coefficient: environmental knowledge and environmental concern. The concept of reliability assumes that unidimensionality exists in a sample of test items and if this assumption is violated it does cause a major underestimate of reliability (Tavakol & Dennick, 2011, p.54). The high value for Cronbach's alpha indicates good internal consistency, but does not mean that the scale is unidimensional (Tavakol & Dennick, 2011; Gliem & Gliem, 2003). In the specific, Factor analysis is one method to determine the dimensionality of a scale (Tavakol & Dennick, 2011; Gliem & Gliem, 2003). Table 1 shows the result of Factor Analysis.



Table 1. Factor Analysis Result

	Component					
	1	2	3	4	5	6
EK2						0.763
EK3						0.770
EC1			0.667			
EC3			0.699			
EC4			0.748			
SN3					0.893	
SN4					0.589	
PF1	0.830					
PF2	0.727					
AT1				0.790		
AT2				0.728		
PI1		0.800				
PI2		0.765				

Source: analysis of field data

A 13-items confirmatory factor analysis was also employed. CFA testing allowed research model to give confirmation on the variables in measuring the analyzed factors. The result of confirmatory analysis as follows: GFI= 0.933, AGFI= 0.895, RMR= 0.040, NFI= 0.843, CFI= 0.941, PNFI= 0.621, PCFI= 0.693, RMSEA= 0.051.

Table 2. Standardized regression weights (CFA)

		Estimate
EC4	<-- E - C	.629
EC3	<-- E - C	.661
EC1	<-- E - C	.551
SN4	<-- S - N	.994
SN3	<-- S - N	.501
PF3	<-- PF -	.752
PF2	<-- PF -	.647
PF1	<-- PF -	.788
GPI 2	<-- G - PI	.782
GPI 1	<-- G - PI	.712
EK 3	<-- E - K	.350
EK 2	<-- E - K	.435
AT 2	<-- A - T	.702

AT <-- A	.639
1 - T	

Source: analysis of field data

After the CFA is tested, the next step is structural analysis. The following is the results of structural analysis (Table 3 and 4), CMIN= 120.674, GFI= 0.919, AGFI= 0.880, RMR= 0.046, NFI= 0.808, CFI= 0.907, PNFI= 0.630, PCFI= 0.708, RMSEA= 0.062.

Table 3. Standardized regression coefficient (Structural)

			Estimate
AT	<---	EC	.320
AT	<---	SN	.101
AT	<---	EK	-.047
AT	<---	PF	.321
GPI	<---	AT	.669
EK3	<---	EK	.425
EC4	<---	EC	.427
EC3	<---	EC	.654
EC1	<---	EC	.563
EK2	<---	EK	.529
SN4	<---	SN	.682
SN3	<---	SN	.710
PF3	<---	PF	.757
PF2	<---	PF	.643
PF1	<---	PF	.782
AT1	<---	AT	.638
AT2	<---	AT	.657
GPI1	<---	GPI	.737
GPI2	<---	GPI	.804

Source: analysis of field data



Table 4. Structural Equation Model

	Hypothesized Relationship	Estimate	CR	p-value	Conclusion
H1	Attitude <--- Environmental Knowledge	-0.047	-.341	.773	Not Supported
H2	Attitude <--- Environmental Concern	0.320	2.210	0.027	Supported
H3	Attitude <--- Subjective Norms	-0.101	-.629	0.529	Not Supported
H4	Attitude <--- Price Fairness	0.321	2.066	0.039	Supported
H5	Purchase Intention <--- Attitude	0.669	6.175	***	Supported

Source: analysis of field data

According to Table 4, three of five hypotheses are supported. A hypothesis will be indicated as supported one if the correlation is drawn significantly which is critical ratio should be ± 1.96 and p value is ≤ 0.05 . Based on the result above, H₂, H₄, and H₅ are the supported hypotheses while H₁ and H₃ are unsupported hypotheses. Hypothesis 1 reported there are negative relationship between environmental knowledge and attitude. Critical ratio for hypothesis 1 presented negative result that was contradictory with this hypothesis. Therefore, it can be concluded that hypothesis 1 is not supported. On the other hand, hypothesis 2 showed that environmental concern is positively related to the attitude. P value for this hypothesis was in accordance with the requirement value that is ≤ 0.05 (i.e. 0.027).

Hypothesis 3 stated the negative relationship between subjective norms and attitude (p value = 0.404). In addition, critical ratio of hypothesis 3 pointed negative result. It implies



that subject norms and attitude have a negative relationship. On the other words, hypothesis 3 was not supported. Hypothesis 4 represented negative relationship between price fairness and attitude's value of hypothesis 4 did not exceed the standard of *p value*. Moreover, hypothesis 5 presented that attitude has a positive relationship to green purchase intention. The result of critical ratio is above 1.96 and p value also less than 0.05 (i.e. 0.002)

DISCUSSION

After the hypotheses were tested, the result showed that three of five hypotheses were supported and the rest was not supported. Supported hypotheses are hypothesis 2, hypothesis 4, and hypothesis 5. On the contrary, unsupported hypotheses are hypothesis 1 and hypothesis 3. The following is further discussion regarding the reasons of either supported or unsupported hypotheses.

Analysis of hypothesis 1 indicated that the hypothesis was not supported. There are three reasons why this hypothesis was not supported. First, the respondents did know about Body Shop products, but completely saw no differences for their health or impact for environment. Second, even if consumers are knowledgeable, still, they have no interest in buying green products such as Body Shop. Consumers may choose other brands which more suitable with their lifestyle. Other brands have more various kinds of cosmetics and or variance. Third, using established and well-known brands, for example Face Shop and Innisfree brought different feeling regarding their pride.

Hypothesis 2 stated that there is positive relationship between environmental concern and attitude. The second hypothesis in this research was supported. Three reasons were found to explain why the hypothesis was supported. First, respondents are aware in buying eco-friendly products and put it into consideration when they make a purchase decision. In addition, respondents also try to reduce the use of plastic bags. Second, respondents felt anxious if the products they used contain harmful materials. Third, previous studies supported that environmental concern is positively related to attitude as well (Irianto, 2015; Aman *et al.*, 2012; Kim & Chung, 2011; Chen, 2009; Lee, 2008; Laskova, 2007). Therefore, hypothesis 4 in this research was supported.



Hypothesis 3 indicated that the hypothesis was not supported. There are two main reasons why this hypothesis was unsupported. First, people around the respondents mostly did not give any contribution in buying decision making. They made one product as the preference based on past experience, advertising, or probably other special offerings, such as promotion and discount. Second, simply few people or even no one used Body Shop products around them. Therefore, the respondents have no any recommendations or suggestions about the Body Shop products. They did not get what benefit or what is good about Body Shop that different from other competitors.

Hypothesis 4 stated that subjective norm is negatively related to attitude. The fourth hypothesis in the research was supported. These are four reasons why the hypothesis was supported. First, the price of Body Shop products is not in accordance with the benefit offered. Respondents thought the price is too high for green products such as Body Shop products. Second, the price respondents paid for Body Shop products were not in accordance with the quality. The price charged by Body Shop is quite high rather than other brands with same average quality. Third, the price offered by Body shop is not fair and not affordable for some respondents.

Hypothesis 5 stated that there is positive relationship between attitude and green purchase intention. The fifth hypothesis of the research was supported. Four reasons were found to explain why this hypothesis was supported. First, respondents thought that the idea of green products run by Body Shop is good and it is likeable. Body Shop is well-known as one of manufacturers that concern about environment and use natural materials (Ling, 2013; Teng *et al.*, 2012). Second, respondents have a favorable attitude towards Body Shop products. Body Shop provided products which less harmful for environment and contained safe materials. Third, respondents agreed that recycling programs done by Body Shop can reduce pollution. Body Shop packaging designed to be recyclable. Fourth, previous studies also supported that environmental attitude is positively related to green purchase intention (Rahim, 2015; Magistris & Gracia, 2008; Mostafa, 2007; Tarkiainen & Sundqvist, 2005; Ajzen, 1991).



CONCLUSION, LIMITATIONS AND FUTURE RESEARCH

This research was carried out to answer the research questions. Based on the research analysis, can be concluded that three hypotheses were supported and two hypotheses are unsupported. The following are result of hypotheses testing:

- 1) The environmental concern is positively to the attitudes
- 2) The price fairness is negatively related to the attitudes
- 3) Attitude is positively related to the green purchase intention

Apart from the results and purpose, this research was not assuredly exempt from limitations. There are three limitations occurred when the research was conducted. First, this research used non-probability sampling. Judgement sampling was chosen for this research for the purpose of reducing costs, time, and energy. Consequently, not all the population obtains the same opportunity to be chosen as sample. The sample is limited for students in one private university.

Second, unit analysis for the research is students of private university. The respondents for future research can be directed to the larger sample such as students for another university or workers. By using different unit analysis, the result is expected to remain the same. Third, this research just use one object, specifically one brand to be examined (e.g. Body Shop). It will be better if the next research can include more than one object. The aim is to obtain the result more accurately. Therefore, the next researchers are able to implement and assess the similar instrument to get the identical result as well.

REFERENCES

- Ajzen, I. (1991). The Theory of Planned Behavior. *Organizational Behavior and Human Decision Processes*, 50(2), 179-211.
- Ajzen I. (2005). *Attitudes, Personality, and Behavior*. (2nd Ed.). Britain: Open University Press.
- Ajzen, I. (2012). Martin Fishbein's Legacy: The Reasoned Action Approach. *The ANNALS of the American Academy of Political and Social Science*, 640(1), 11-27.
- Ajzen, I. (2014). The Theory of Planned Behavior is alive and well, and not ready to retire: A Commentary on Snichotta, Pesseau, and Araujo-Soares. *Health Psychology Review*.



- Akbar, Waseem et al. (2014). Antecedents Affecting Customer's Purchase Intentions towards Green Products. *Journal of Sociological Research*, 5(1), 273-289.
- Ali, A. & Ahmad, I. (2012). Environmental Friendly Products: Factors that Influence the Green Purchase Intentions of Pakistani Consumers. *PJETS*, 2(1), 84-117.
- Aman, A.H.Lizawati, Harun, Amran and Hussein, Zuhail (2012). The Influence of Environmental Knowledge and Concern on Green Purchase Intention The Role of Attitudes as A Mediating Variable. *British Journal of Arts and Social Sciences*, 7(II), 145-167.
- Anic, Ivan-Damir (2014). Attitudes and Purchasing Behavior of Consumer in Domestic and Foreign Food Retailers in Croatia. Department of microeconomic analysis, organization and management, 28(1), 113-133.
- Anvar, Muntaha and Marike, Venter (2014). Attitudes and Purchase Behaviour of Green Products among Generation Y Consumers in South Africa. *Mediterranean Journal of Social Sciences*, 5(21), 183.
- Al-Swidi, Abdullah and Huque, Sheikh M.R. (2014). The Role of Subjective Norms in Theory of Planned Behavior in The Context of Organic Food Consumption. *British Food Journal*, 116(10), 1561-1580.
- Banytne, J. Brazioniene, L. and Gadeikiene, A. (2010). Investigation of green consumer profile: A case of Lithuanian market of eco-friendly products. *Economics and Management*, 15, 374-384.
- Barber, Nelson, Taylor, David C., and Strick, Sandy (2009). Environmental Knowledge and Attitudes: Influencing the Purchase Decisions of Wine Consumers. *International CHRIE Conference-Refereed Track*, Paper 16.
- Beckford, c.L., Jacobs, c., Williams, N. and Nahdee, R. (2010). Aboriginal Environmental Wisdom, Stewardship, and Sustainability: Lessons from the Walpole Island First Nations, Ontario, Canada. *The Journal of Environmental Education*, 41(4), 239-248.
- Blackwell, R., D'Souza, C., Taghian, M., Minard, P. and Engel, J. (2007). *Consumer Behaviour: An Asia Pacific Approach*, 1st edn. Thomson Learning, Melbourne, Australia.



- Bonini, S. and Oppenheim, J. (2008). Cultivating the Green Consumer. *Stanford Social Innovation*. 10TH Review Anniversary. 1–10.
- Chang, Pao-Lung, Lee, Kuei-Chiu and Su, Wun-Hong (2013). The Impact of Environmental Education and Product Cognition on Consumers' Purchase Intention on Lithium Battery-Powered Electrical Motorcycles. *International Journal of Engineering and Innovative Technology*, 3(4).
- Chen, M. (2009). Attitude Towards Organic Foods Among Taiwanese as Related To Health Consciousness, Environmental Attitudes, and The Mediating Effects of A Healthy Lifestyle. *British Food Journal*, 111(2), 165-178.
- Chen, I.Y.L., Chen, N. and Kinshuk 2009. Examining the factors influencing participants' knowledge sharing behavior in virtual learning communities. *Educational Technology Society*, 12(1), 134-148.
- Chen, Tan Booi, and Chai, Lau Teck (2010). Attitude Towards the Environment and Green Products: Consumers' Perspective. *Management Science and Engineering Journal*, 4(2), 27-39.
- Chyong, H.T, Phang, G, Hasan, H. and Buncha, M.R. (2006). Going green: A study of Consumers' Willingness to Pay for Green Products in Kota Kinabalu. *International Journal of Business and Society*, 7(2), 40-54.
- Conraud-Koellner, E. and Rivas-Tovar, L. (2009). Study of Green Behavior with A Focus On Mexican Individuals. *iBusiness*, 1, 124-131.
- D'Souza, C., Taghian, M., and Lamb, P. (2006). An empirical study on the influence of environmental labels on consumers. *Corporate Communications: An International Journal*, 11(2), 162-173.
- Davies, A., Titterton, A.J. and Cochrane, C. (1995). Who Buy Organic Food Products? A Profile of the Purchasers of Organic Food Products in Northern Ireland. *British Food Journal*, 97(10), 17-23.
- Dunlap, R. and Jones, R. (2002). Environmental concern: Conceptual and measurement issues. In *Handbook of environmental sociology*, ed. R. Dunlap and W. Michelson. London: Greenwood.



- Durif, F., Biovin, C. and Julien, C. (2010). In Search of a Green Product Definition. *Innovative Marketing*, 6(1), 25-33.
- Effendi, Ihsan, et al. (2015). Analysis of Consumer Behavior of Organic Food in North Sumatra Province, Indonesia. *Journal of Business and Management*, 4, Issue 1:44-58.
- Figueiredo, Joao Neiva de, Guillen, Mauro F. (2012). Green Products: Perspectives on Innovation and Adoption, Boca Raton: CRC Press Taylor and Francis Group.
- Fishbein, M. and Ajzen, Icek (1975). *Belief, attitude, intention and behavior: An introduction to theory and research*. MA, Addison-Wesley.
- Gliem, J.A. and Gliem, R.R. (2003). Calculating, Interpreting, and Reporting Cronbach's Alpha Reliability Coefficient for Likert-Type Scales. *Paper presented at Midwest Research to Practice Conference in Adult, Continuing, and Community Education*. Available at:
<http://www.ssnpstudents.com/wp/wp-content/uploads/2015/02/Gliem-Gliem.pdf>
- Gracia, A., de Magistris, T., and Barreiro-Hurle, J. (2010). Why do we buy organic? Integrating knowledge, attitudes and concerns in a simultaneous equation model for Spanish consumers. Paper presented at the 119th EAAE Seminar 'Sustainability in the Food Sector, Capri, Italy.
- Haryanto, B. and Budiman, S. (2014). The Role of Environmental Knowledge in Moderating the Consumer Behavioral Processes Toward the Green Products (Survey on the Green Product-mind in Indonesian). *Review of Integrative Business and Economics Research*, 4(1), 203-216.
- Hasbullah, Norazlan, Mahajar, Abdul Jumaat, and Salleh,. Mad Ithnin (2014). Extending The Theory of Planned Behavior: Evidence of The Arguments of its Sufficiency. *International Journal of Humanities and Social Science*, 4(14), 101-105.
- Ibragimova, B., Ryan, S.D., Windsor, J.C. and Prybutok, V.R. 2012. Understanding the antecedents of knowledge sharing: an organizational justice perspective. *Informing Science: the International Journal of an Emerging Transdiscipline*, 15, 183-205
- Irianto, Heru (2014). Consumers' Attitude and Intention Towards Organic Food Purchase: An Extension of Theory of Planned Behavior in Gender Perspective. *International Journal of Management, Economics, and Social Sciences*, 4(1), 17-31.



- Ishaswini, Saroj Kumar Datta (2011). Pro-Environmental Concern Influencing Green Buying: A Study on Indian Consumers. *International Journal of Business and Management*, 6(6), 124-133.
- Kaiser, F.G., Wolfing, S. and Fuhrer, U. (1999). Environmental Attitude and Ecological Behaviour. *Journal of Environmental Psychology*, 19,1-19.
- Karatu, Victoria Masi H., Nik Mat, Nik Kamariah (2015). Predictors of Green Purchase Intention in Nigeria : The Mediating Role of Environmental Consciousnes. *American Journal of Economics*, 5(2), 291-302.
- Khraim, Hamza Salim, Al-Jabaly, Sameer M., and Khraim, Aymen S. (2014). The Effect of Perceived Value and Customer Satisfaction on Perceived Price Fairness of Airline Travelers in Jordan. *Journal of Marketing*, 74: 18–31.
- Kim, H.Y. and Chung, J.E. (2011). Consumer Purchase Intention for Organic Personal Care Products. *Journal of Consumer Marketing*, 28(1), 40-47.
- Kotler, P. and Armstrong, G. (2010). *Principles of Marketing*, 13th ed. New Jersey: Prentice Hall.
- Kuang, L.C., Davidson, E. and Yao, L. 2012. A planned behavior-based investigation of knowledge sharing in construction industry. *Proceedings of International Management and Engineering Conference (EMC 2012)*. Available at: umpire.ump.edu.my/3187/1/Lee_EMCC_2012.paper.pdf
- Laroche, Michel, Bergeon, Jasmin, Barbaro-Forleo, Guido (2010). Targeting Consumers Who are Willing to Pay More for Environmentally Friendly Products. *Journal of Consumer Marketing*, 18(6), 503-520.
- Laskova, A. (2007). Perceived Consumer Effectiveness and Environmental Concerns. *Proceedings of the 13th Asia Pacific Management Conference*, Melbourne, Australia, pp. 206-209.
- Lee, K. (2008). Opportunities for green marketing: Young consumers. *Marketing Intelligence and Planning*, 26(6), 573-586.
- Lin, H. and Lee, G. 2004. Perceptions of senior managers toward knowledge-sharing behavior. *Management Decision*, 42(1), 108-125.



- Ling, Chan Yew (2013). Consumers Purchase Intention of Green Products: An Investigation of the drivers and moderating variable. *Elixir Marketing Management International Journal*, 57A, 14503-14509.
- Luchs, M. G. et al. 2010. The Sustainability Liability: Potential Negative Effects of Ethicality on Product Preference. *Journal of Marketing*, 74, 18–31.
- Magistris, T. and Gracia, A. (2008). The Decision to Buy Organic Food Products in Southern Italy. *British Food Journal*, 110(9), 929-947.
- Mahesh, N.(2013). Consumer's Perceived Value, Attitude and Purchase Intention of Green Products. *Management Insight Journal*, 9(1), 36-43.
- Mahmood, A., Qureshi, M.A. and Shahbaz, Q. 2011. An examination of the quality of tacit knowledge sharing through the theory of reasoned action. *Journal of Quality and Technology Management*, VII(I), 39-55.
- Mostafa, M.M. (2007). Gender differences in Egyptian consumers' green purchase behaviour: The effects of environmental knowledge, concern and attitude. *International Journal of Consumer Studies*, 31(3), 220–209.
- Nik Abdul Rashid, N.R. (2009). Awareness of Eco-label In Malaysia's Green Marketing Initiative. *International Journal of Business and Management*, 4(8), 132-141.
- Ottman, J.A. (1998). *Green Marketing: Opportunity for Innovation*. Second Edition, BookSurge.
- Pavan, M. P. S. (2010). Green Marketing in India: Emerging Opportunities and Challenges. *Journal of Engineering, Science and Management Education*, 3, 9–14.
- Rahab and Wahyuni, P. 2013. Predicting knowledge sharing intention based on theory of reasoned action framework: an empirical study on higher education institution. *American International Journal of Contemporary Research*, 3(1), 138-147.
- Roberts, J. A. and Bacon D. R.(1997). Ecologically conscious consumer buying. *Journal of Business Research*, 40, 79-89.
- Saeed, Rashid et al. (2013). Measuring Impact of Factors Influencing Purchase Intention Towards Green Product: Sahiwal Clothing Industry Perspective. *World Applied Sciences Journal*, 26(10), 1371-1379.



- Saleki, Z. S., Seyedsaleki, S. M., and Rahimi, M. R. (2012). Organic food purchasing behavior in Iran. *International Journal of Business & Social Science*, 3(13), 278-285.
- Salleh, Musdiana Mohamad et al. (2010). Consumer's Perception and Purchase Intentions Towards Organic Food Products: Exploring Attitude Among Academician. *Canadian Social Science*, 6(6), 119-129.
- Sangkumchaliang, Parichard, and Huang, Wen-Chi (2012). Consumers' Perceptions and Attitudes of Organic Food Products in Northern Thailand. *International Food and Agribusiness Management Review*, 5(1), 87-102.
- Suki, NorazahMohd. (2012). Green Awareness Effects on Consumers' Purchasing Decision: Some Insights From Malaysia. *IJAPS*, 9(2), 49-63.
- Sun, J., and Wilson, V.L. (2008). Assessing General and Specific Attitudes in Human Learning Behaviour: An Activity Perspective and A Multilevel Modeling Approach. *Educational and Psychological Measurement*, 66, 245-261.
- Tanner, C. and Kast, S. W. (2003). Promoting Sustainable Consumption: Determinants of Green Purchases by Swiss Consumers. *Psychology & Marketing*, 20(10), 883-902.
- Tarkiainen, A. and Sundqvist, S. (2005). Subjective Norms, Attitudes and Intentions of Finnish consumers in buying organic food. *British Food Journal*, 107 (11), 808-822.
- Tavakol, M. and Dennick, R. (2011). Making Sense of Cronbach's Alpha. *International Journal of Medical Education*, 2, 53-55.
- Teh, P., Yong, C., Chong, C. and Yew, S. 2011. Do the big five personality factors affect knowledge sharing behavior? A study of Malaysian universities. *Malaysian Journal of Library & Information Science*, 16(1), 47-62.
- Teh, P. and Yong, C. 2009. Knowledge sharing in IS personnel: organizational behavior's perspective. *Journal of Computer Information System*, Summer, 11-21.
- Rezai, Golnaz., Teng, Phuah Kit, Mohammed, Zainalabidin, and Shamsudin, Mad Nasir (2013). Consumers' Awareness and Consumption Intention Towards Green Foods. *African Journal of Business Management*, 6(12) 4496-4503.
- Terenggana, Candra Astra, Supit, Henky, and Utami, C. W. (2013). Effect of Value, Consumer Trust and Attitudes Towards Intention Buy Environmental Friendly Air



- Conditioners Product in South Sumatera. *Social Sciences and Humanities*, 4(3), 323-335.
- Tuan, Nguyen Minh (2012). Effects of Service Quality and Price Fairness on Student Satisfaction. *International Journal of Business and Social Science*, 3(19).
- Wilson, E. (2007). A World Consumed by Guilt. *The New York Times*. Retrieved March 2, 2008 from <http://www.nytimes.com>.
- Wu, K., Huang, D., and Teng, Y. (2013). Environmental Concern, Attitudes and Intentions towards Patronage of Green Restaruants. *Life Science Journal*, 10(4), 2329-2340.
- Young, W., Hwang, K., McDonald, S. and Oates, C. J.(2010). Sustainable Consumption: Green Consumer Behaviour When Purchasing Products. *Sustainable Development*, 18, 20–31.
- Zainudin, N. (2013). Attitudes Towards Energy Efficient Product: The Influence of Eco-Literacy and Social Influence. *E-Journal of Integration Knowledge*.



**SOCIAL AND ENVIRONMENTAL ACCOUNTING AND RELEVANCE VALUE: AN
ANALYSIS IN LATIN AMERICA**

Sandra Pastor

Facultad de Ciencias Económicas, Universidad de Centro de la Provincia de Buenos Aires,
Argentina

Valeria Perez

Facultad de Ciencias Económicas, Universidad Nacional del Litoral, Argentina
valegperez@live.com

Abstract

With the emergence of the Social and Environmental Accounting discipline you can perform analysis of the accounting information in the non-financial matters, providing with their tools the analysis of transparency and legitimacy to the decisions of the organizations regarding the social and environmental information.

This research proposes to investigate the evolution that is observed in the disclosure of Social and Environmental Information (ISA) in the financial system, analysing the sustainability reports of the entities contributors in Argentina, Chile and Brazil, during the years 2005 to 2015.

The search for the relationship between the disclosure of social and environmental information, and the relevance values of their actions, taking the Ohlson model, expressed the need to find the information through reports or sustainability reports submitted by them and the contributions of its shares in the stock market, as secondary sources of information accessible to the demands of this research.

This work integrates the research project, and it is expected to find no evidence to establish the link between social and environmental information and the impact on the valuation of the entities contributors between the years 2005 and 2015, understanding that such voluntary reports positively affect the development of the organization.

Keywords: *disclosure of social and environmental information, sustainability report*

JEL Classification: *Q56*



INTRODUCTION

From the last decades of the 20th century, the analysis of accounting has seen changes in the edges that cause changes in the determination of the decision-making on the part of the different users of the information she provided through the accounting reports.

In this sense, the traditional accounting that focuses on the analysis in the economic and financial aspects of the accounting information from the organizations, has been limited in the disclosure of non-financial aspects. Therefore, with the emergence of the Social and Environmental Accounting discipline you can perform analysis of the accounting information in the non-financial matters, providing with their tools the analysis of transparency and legitimacy to the decisions of the organizations regarding the social and environmental information. The Social and Environmental Accounting proposes the preparation and dissemination of information

On the interactions and activities of a social, environmental, linked to human resources, to the community, customers, among others, of an organization and, where possible, the consequences of these interactions and activities.

The Social Accounting can contain financial information, but it is most desirable that consists of a combination of non-financial information and quantifiable, on the one hand, and non-quantifiable and descriptive information, on the other. (Gray et al, 2003)

There is a history of research related to the increasing interest by users of the information according to the social and environmental aspects of the accounting information.

Therefore, this research proposes to investigate the evolution that is observed in the disclosure of Social and Environmental Information (ISA) in the financial system, analysing the sustainability reports of the entities contributors in Argentina, Chile and Brazil, during the years 2005 to 2015.

CONTRIBUTION OF THIS RESEARCH

Inquiries regarding the information disclosed by entities contributors with respect to social and environmental issues are formulated in terms of finding how is the representativeness closest to that reality so that it is reliable, useful information for the



interest groups or stakeholders about the impacts of their activities, projects, from the approach of CSR.

The aim of this study is linked with the social construction of accounting and its credibility as a source for decision-making on the part of the users of such information; decisions of social, economic, ecological, technological, political, contributing to the construction of the quality of life of each one of the agents associated with the entity (the workers, investors, the State, institutions, professionals, the nature, consumers, citizens) (Brown, 1992).

The social relevance of this type of study was put in evidence by the so-called crisis of confidence in the accounting, caused by the presentation of fraudulent accounting information in internationally renowned companies and their complicity with the economic crisis which occurred subsequently (Bautista, 2010).

The freedom to achieve the credibility of accounting information, is exercised by the capacity that the body has to apply the accounting rules, adapting to them by the goodwill (Sen, 1996), and its subsequent control on the part of the parastatal institutions, such as ethical-political intervention of the State.

The disclosure of social and environmental information by financial institutions listed has its significance for different interest groups or stakeholders, and this is evident in the existence of corporate sustainability indices, which incorporates social responsibility criteria, in the securities markets where the organizations listed. The incorporation of these indicators to reveal the implications of this information, it is a variable of interest for all stakeholders, which shows the development achieved in the subject.

The environmental aspect is the greater interest of analysis therefore focused interest groups linked with economic organizations that measure and report the social and environmental impacts of its activity results.

The study of the characteristics and the knowledge of the variables that are taken into account for its construction are of importance for the comparative analysis between the various markets of information and its variation over time according to the profile of the stakeholders to whom it is directed.



The relationship between the indicators presented and the decisions of the stakeholders in the analysis and interpretation of results in the need to implement ad hoc systematized information aimed at investors informed, causing new analysis and the use of empirical methodology in the study of this topic in our area of influence.

QUESTIONS PROBLEMS

- What are the characteristics of the indicators of disclosure of social and environmental information of the entities contributors in Argentina, Chile and Brazil?
- What are the interest groups or stakeholders involved in such disclosure?
- What is the relationship between the evolution of the disclosure of the ISA and the relevance values of the entities contributors listed in Argentina, Chile and Brazil?

HYPOTHESIS

There is a positive relationship between the evolution of disclosure of the ISA and the relevance values of the actions of entities contributors in Argentina, Chile and Brazil.

GENERAL OBJECTIVE

To analyze the evolution of the disclosure of social and environmental information (ISA) by entities contributors in Argentina, Chile and Brazil during the years 2005-2015.

SPECIFIC OBJECTIVES

- Identify instruments of disclosure of social and environmental information in the companies of both countries and its variation in the period
- To comparatively analyze and over time the interest groups (stakeholders) involved in such disclosure
- Establish the evolution of the relationship between the dissemination of the ISA and the listing of companies in both countries from the Model Olhson



BACKGROUND

The research in the accounting discipline has evolved over the past century, from a perspective of research "a priori" oriented to the objective measurement of the benefit and is linked with the development of normative theories, to a perspective of empirical research, which is given by the change of user-oriented paradigm of the accounting information, pointing to the achievement of the greatest possible use of the information. (Elchaimi, 2002).

For its part, the epistemological status of Accounting is still a matter of debate (Casella, 2012; Tua Pereda, 2004; Pinto Perry, 2011), a starting point for establishing the location of the social and environmental accounting in the field of accounting as a discipline, is located in the interpellation to establish which is the object of study of the accounting, that is to say, that it addresses.

In this sense, from a teleological perspective of accounting, this is to register the economic facts that made the economic agents. These registrations are presented through the accounting information, which reveals the financial situation, economic and social entities. As Gomez (2007, p.36) "The diversity of resources and the multiple relationships of humans with the resources and among men, are reduced to the unity by means of the "representation-construction" of the reality that makes the double-entry accounting".

The observation of this accounting information, the various users of the same, according to the paradigm of utility (Tua Pereda), can make decisions in the economic, financial and social respect the economic agent.

In this sense, the debate regarding the field of membership of the social and environmental accounting is still valid. This can be seen in the work of Gray (1999), in which it performs a historical review of the evolution in the conception of this discipline and the discussions regarding the origins of the same, differing from the financial accounting under the new social perspectives that covers its analysis.

The social and environmental accounting is evident from the new needs that users require the accounting information based on a level of equity and social inclusion, rather than in the service of the market, both internal and external users, combining non-financial information and quantifiable and non-quantifiable and descriptive information (García Fronti, 2006), including an interdisciplinary analysis, related to the concept of social responsibility -



derived from the discipline of administration - and the issues of the impact of economic activities on the environment.

This feature to consider other disciplines is related with the information provided by the social accounting, the sustainability reports. The preparation and publication of information with regard to the economic, social, environmental, human resources and the demands of different users, require that the social and environmental accounting considers both the issues of financial information such as those that are not of this kind, and to do this, is to observe the issues of those other disciplines.

Through the sustainability reports, the social and environmental accounting responds to the different demands of users (stakeholders) with regard to the information of the sending organization of those reports. Interest groups are dynamic and vary in relation to each organization, therefore, the sustainability reporting are adapted to these demands, and social accounting interacts with the organization through the revision of the system of internal information in order to be able to disclose information about sustainability tool to the stakeholders of the same.

For this reason, the relationship between financial accounting and social and environmental accounting, based on reports from mandatory financial information, and the demands of sustainability reports on the part of the stakeholders, power to the social and environmental accounting as significant discipline that disseminates this instrumental accountability of social responsibility.

Under that the reports of financial information, mandatory, do not provide for the demands of the stakeholders in relation to the values of organizational, social and environmental policies of the Organization, the impact of that organization in generations, the social and environmental accounting articulates from the financial information, quantitative and qualitative information, in order to achieve the emission of information of sustainability.

On the basis of that information, there is a materiality matrix that identifies the issues relevant to the stakeholders.

For its part, the *theory of the legitimacy of* the congruence between the values system of an organization and of the society of which it forms a part. For the company to keep this



legitimacy, must address strategies to be developed in a positive way and without giving rise to the handling, as can be the change of public perception in your favor, manipulate and hide information. The disclosed information social and environmental organizations, on a voluntary basis, this theory begins to be seen as a natural justification of these actions. Many organizations in search of legitimacy are beginning to develop programs of corporate responsibility, although this is not sufficient reason is necessary to begin to improve the image of the same.

Meanwhile, in the decade of 1980 was the vision of the *Social Contract* as the means by which it is estimated there is a covenant between the organizations and the society, research, finding that the reciprocal expectations of both parties under the assumption that the organizations were interested in maximizing the benefits and minimizing the risks, creating a balance between the two.

The *stakeholder theory* or interest groups considered to those groups or individuals can affect or be affected by the economic activities of the entity (D'Onofrio, 2014), and is based on the concept of social responsibility, which comes from management, and that it is under an ethical approach analyzes the manifestations of the entity in relation to the organizational strategies toward sustainable development, that is to say, to perform economic activities with the least environmental and social prejudice, for future generations and considering the profitability of such activities.

Interest groups are determined in function of the power, legitimacy and the urgent claims made before the entity.

THEORIES OF RELEVANCE VALUES

The emergence of these theories is contextualized with the change of paradigm in accounting research, glimpsing the attention to the usefulness of accounting information for decision-making.

There are derived from theories of analysis with respect to the valuation of the shares of listed companies on the basis of the information available to them, recognized as theories of relevance values. They admit that the accounting result is a good surrogate of the economic result and that the net asset is of corporate wealth. (Garcia, 2005)



Analyze how the accounting variables explain the market prices. There are several ways to measure this relationship, and its basic model would be:

$$P_{i,t} = \alpha + \beta_1 BV + \beta_2 EARN_{i,t} + \varepsilon_{i,t}$$

Where, P = measure of performance possible future, BV = Heritage PS, EARN = EPS, $\varepsilon_{i,t}$ = error term $n(0,1) < \text{Expectation } 0 < \beta_1 > < \beta_2 >$ is the multiple of the result - The goodness of the model (R²) can also be used as a measure of quality, the more, the better the outcome

THE EBO.

One of the theories of relevance evaluative reconciles the fundamental analysis with the theory of valuation. With the fundamental analysis it is understood that the determination of the intrinsic value of the titles were generated from the available accounting information in the financial statements.

In the perspective of measurement through the so-called model EBO, fundamental analysis is reconciled with the theory of valuation, to the extent that it recognizes the need to predict future abnormal results of the company as a prerequisite for the determination of the intrinsic value of their actions

THE MODEL OHLSON (1995)

According to this model, with the hypothesis of balance in the market, analyzes the existence of implicit price of shares, "who are the ones who ultimately determine the present value of an uncertain future dividends, anticipated future dividends being an attribute of capitalization generally valid" (Larrán y Piñero, 2005).

The development of this model is a formula of values in which the price quoted is a function of the expected future dividend adjusted according to the level of risk and current values using a structure based on rates of return to market risk-free

$$P_t = \sum_{i=1}^{\infty} \frac{E_t(\tilde{d}_{t+i})}{(1+r_f)^i}$$



The dividends is an attribute that determines the value of the titles such as weighting of the flows of income that would have investors and the company. This variable may be replaced by other of an accounting nature becoming the model to a different description.

As well, there are the models of capitalization of profits, where the dividends are replaced by theoretical concepts of profit, establishing and specifying the relationship between dividends and profit to be used. (AECA, 2006)

In addition, a simple way to estimate the future expectations of results, based on accounting information, focusing on the determinants of the value of the organization: the equity and the result, which expresses the value of the actions of the organization on the basis of contemporary accounting information. This expression states that the value of the actions of the organization must be equal to equity, adjusted for the current profitability (measured through the abnormal result) and by the "other information" that modifies the prediction of future profitability.

This "other information" is the one that will deal with the reports of ISA and the sustainability reports submitted by the financial institutions listed companies analyzed.

METHODOLOGY

In this research we propose a scheme of descriptive correlation study, on the basis of the behavior of the variables of the study and how they relate to each other. (Ynoub, 2015)

As outlined in the problem, the search for the relationship between the disclosure of social and environmental information by contributors in Argentina, Chile and Brazil, and the relevance values of their actions, taking the Ohlson model, expressed the need to find the information through reports or sustainability reports submitted by them and the contributions of its shares in the stock market, as secondary sources of information accessible to the demands of this research.

The *units of analysis* are the entities contributors of these countries, which, being of recognition feasible in the light of the information provided by two securities markets, as shown in the total population between the years 2005 and 2015, for the overall objective of the investigation.



For the development of the objectives the following data arrays, which will be diachronic, apply for the years 2005 to 2015, for the securities markets of analysis, namely as outlined below, in order to answer the questions:

-What are the characteristics of the indicators of disclosure of social and environmental information of the financial entities contributors in Argentina?

Table 1

UNIDAD DE ANALISIS	VARIABLES	VALOR (V)	DIMENSIONES / INDICADORES	
Empresas Financieras cotizantes en Mercado Capital Argentino	Características Social	tipo de guía aplicada GRI	Valor s/GRI	
	Características Ambiental	tipo de guía aplicada GRI	Valor s/GRI	
	Modelo de Ohlson	Precio de cotización a T1		
		Precio de cotización a Tn		
		Valor Activos		
	Valor Pasivos			

The analysis is replicated to the entities in Chile and Brazil.

- What are the interest groups or stakeholders involved in such disclosure?
- What is the relationship between the evolution of the disclosure of the ISA and the relevance values of the entities contributors?

Table 2

UNIDAD DE ANALISIS	VARIABLES	VALOR (V)	DIMENSIONES / INDICADORES	VALOR (I)
Empresas Financieras cotizantes en Mercado Capital Argentino	Divulgacion ISA	instrumentos utilizados (GRI)		
		Indicadores utilizados		
		stakeholders		
	relacion entre divulgación y cotizacion	relacion simetrica	precios de cotizacion	según la relacion de Ohlson
		relacion directa	valor activos valor pasivo	

The development of the data array comes with the application of the Ohlson model for the resolution of the problem.

DATA ANALYSIS

We will analyze the variables of the disclosure of social and environmental information submitted by the contributors of Argentina, Chile and Brazil, looking for evidence of impacts that it can generate in the relevance values of the Ente



CONCLUSIONS

This work integrates the research project (2017/2019) that the authors are being drafted, and it is expected to find evidence to establish the link between social and environmental information and the impact on the valuation of the entities contributors in Argentina, Chile and Brazil between the years 2005 and 2015, understanding that such voluntary reports positively affect the development of the organization. The development of the data array comes with the application of the Ohlson model for the resolution of the problem.

On the basis of the identified impacts and comparisons that can be made between socially responsible financial contexts and those that do not are, you will try to understand the potential impacts of the social responsibility in Argentina and other Latin American scenarios addressed.

REFERENCES

- AECA (Asociación Española de Contabilidad y Administración de Empresas) (2006) Aplicabilidad del Modelo de Ohlson para la Valoración de Acciones. Documento N°8.
- Brown, M. (1992). "Análisis de la organización y sus acciones" en *La ética en la empresa. Estrategia para la toma de decisiones*, 103-129. Buenos Aires, Paidós.
- Bautista, J.A. (2010). Lo público para la contabilidad y la contabilidad para lo público: caminos de investigación y alternativas de desarrollo contable. *Revista Activos*, 14, 111-130.
- D'Onofrio, P. (2014). Impactos ambientales de la agricultura, enfoque desde el sistema de Información contable. Buenos Aires: Universidad de Buenos Aires, Facultad de Ciencias Económicas.
- Elchaimi, M. (2002). *La investigación empírica en la contabilidad y su estrecha vinculación con la estadística*. Séptimas Jornadas "Investigaciones en la Facultad" de Ciencias Económicas y Estadística, UNR.
- Foucault, Michel (1984). *Cómo se ejerce el poder*. En: <http://www.unizar.es/deproyecto/programas/docusocjur/FoucaultPoder.pdf>



- Gómez, M. (2007). Pensamiento único y Contabilidad: la posibilidad de la Contabilidad como disciplina moral. *Revista de la Facultad de Ciencias Económicas de la Universidad Militar Nueva Granada*, XV (2). Colombia.
- García Fronti, I. (2006). Fundamentación teórica de la contabilidad social: con énfasis en las cuestiones micro (Tesis Doctoral)
- García Osma, B., Gill de Albornoz Noguera, B. y Gisbert Clemente, A. (2005) “La investigación sobre earnings management” *Revista Española de Financiación y Contabilidad* 127, 1001-1034.-
- Gray, R. (2003). “Acerca del desorden, los sistemas y la sustentabilidad: Hacia una contabilidad y unas finanzas más sociales y ambientales”, traducción M.C. Rodríguez de Ramirez, *Contabilidad y Auditoría*, Publicación del Instituto de Investigaciones Contables, 9 (17), 143-168.
- Gray, R. (2005). Taking A Long View On What We Now Know About Social And Environmental Accountability And Reporting. (E Journal) *Radical Organisation Theory*, 15pp
- Pinto Perry, G. P. (2011). Hacia una metodología de la investigación contable. *Ciencias Económicas* (Universidad Nacional del Litoral, Santa Fe), 1(14), 61-76.
- Sen, A. (1996). “Capacidad y bienestar” en NUSSBAUM, MARTHA y SEN, AMARTYA (COMPS.): en *La calidad de vida*. 54-83. México, FCE.
- Tua Pereda, J. (2004). Evolución y situación actual del pensamiento contable. *Revista internacional Legis de contabilidad y Auditoría*, 20, 43-128. Obtenido de <http://201.234.78.173:8084/publindex/docs/articulos/1692-2913/27/104.pdf>.
- Ynoub, R. (2015). Cuestión de método. Aportes para una metodología crítica. Tomo I. México D.F.: Cengage Learning Editores S.A.



**THE READINESS OF INTEGRATED REPORTING (IR) IMPLEMENTATION ON
COMPANIES PUBLISHING SUSTAINABILITY REPORT IN 2015**

Patriani Wahyu Dewanti

Tegar Galang Anantha

Cahita Widasari

Faculty of Economics, Yogyakarta State University, Indonesia

tegargalanganantha@gmail.com

Abstract

This study aimed to analyze the company's readiness to implement the Integrated Reporting (IR). The objective of the implementation is to enable companies to re-evaluate their business activities in order to create value in a sustainable manner so that the company can present high quality information to stakeholders.

The population of this research are companies that had published Sustainability Report (SR) and listed on the Indonesian Stock Exchange (IDX) in 2015 which amounted to 39 companies. The data analyzed in this study are secondary data from the annual report (AR) and sustainability report (SR) of each company that was published in 2015. The analysis uses 61 indicators that reflect IR eight elements in the <IR> Framework. Research data analysis using descriptive statistical analysis in tabular form the company's readiness categorization.

The result showed that: 31% companies categorized as well prepared to implement the Integrated Reporting. Furthermore 23% companies categorized as prepared to implement the Integrated Reporting, however 26% companies categorized as less prepared to implement the Integrated Reporting, whereas 21% companies categorized as unprepared to implement the Integrated Reporting.

Keywords: Sustainability Reporting, Integrated Reporting

JEL Classification: Q56



INTRODUCTION

The issues of sustainability and transparency have been increasingly created rigidly for both stakeholders and management. This conditions made the stakeholders are very keen to know how business is managed, what the potential risk for the future business are, and what the impacts on society. Stakeholders also want to know the effects of companies' activities on the environment and most importantly about the financial position. Thus, to be sustainable and attractable in this competitive business world, companies require to meet stakeholders' demand by disclosing both financial and non-financial information with demonstrating the sustainable strategies at the first place (Hoque, 2017, p.241). Investor drive not just traditional financial disclosure, but also environmental, social, and governance (ESG) reports (Davis and Lukomnik, 2012, p.44). Thus, the company needs financial and non-financial information disclosure for stakeholders to show sustainability companies strategy. Therefore, company discloses both financial and non-financial information thought different report. Questions arise that how the stakeholders understand disclosed information? Are they able to linkage between financial and non-financial information? What would be their reaction towards company if do not understand? Misunderstanding could lead to worst relationship between the stakeholders and the company. Ultimately, that is a signal for reporting and corporate failure.

The ideal model of report is scalable for future needs, flexible so that users can get customizable reports, and practical, so it provides a useful management tool within the company as well as a disclosure tool for outside stakeholders (Davis and Lukomnik, 2012, p.44). Integrated reporting is one report that comprise both financial and non-financial information, and which additionally present a more holistic picture of the business, including future targets and links between financial performance and CSER (Jensen and Berg, 2011, p.2) One Report means producing a single report that combines the financial and narrative information found in a company's annual report with the nonfinancial (such as on environmental, social, and governance issues) and narrative information found in a company's "Corporate Social Responsibility" or "Sustainability" report (Eccles and Krzus, 2010, p.10). Integrated reporting is a process that results in communicating—through the annual integrated report—value creation over time. An integrated report is a concise



communication about how an organization's strategy, governance, performance, and prospects, in the context of its external environment, lead to the creation of value over the short, medium, and long term (Busco, et.al., 2013, p.7-8).

Research by Adriana (2015) indicate that about 62.22 % of companies that had registered at LQ-45 index are prepared to apply integrated reporting and the others is not ready. These companies have the average level of integrated reporting according to <IR> Framework. This research provides an analysis related to the appropriateness of annual reports of companies compared to <IR> Framework.

This research use sustainability report to analyze the companies readiness to enforce the integrated reporting. Furthermore, Houque (2017, p.242) explained that sustainability reporting is one of the fundamentals in the process of integrated report. It can be viewed as a sub-set of integrated reporting. Therefore, this paper aimed to analyze the company's readiness to implement the integrated reporting (IR). The objective of the implementation is to enable companies to re-evaluate their business activities in order to create value in a sustainable manner so that the company can present high quality information to stakeholders.

LITERATURE REVIEW

Sustainability Reporting

Sustainability reporting as a disclosure that provides information to stakeholders about an organization's attempts to balance its economic, social and environmental goals. In doing so, we make no claims that these reports are in fact reporting on sustainability, as it has been increasingly highlighted in the literature that most business reporting on sustainability has little to do with sustainability (Gray in Robertson and Samy, 2015, p.4).

Sustainability is one of the fundamentals in the process of integrated thinking. In other, word it can be viewed as a subset of integrated reporting (Hoqqe, 2017, p.242). Global Reporting Initiative (2011) defines sustainability reporting as the practice of measuring, disclosing, and being accountable to internal and external stakeholders for organizational performance towards the goal of sustainable development.



Integrated Reporting

Integrated reporting is not just create an integrated report, but the essence is companies can review and reevaluate their business activities to create sustainability value. Integrated reporting contribute to increase quality of companies' information reporting (Adriana, 2015, p.1). Integrated reporting is a process that results in communication by an organization, most visibly a periodic integrated report, about value creation over time. An integrated report is a concise communication about how an organization's strategy, governance, performance and prospects, in the context of its external environment, lead to the creation of value over the short, medium and long term (IIRC in Busco et.al, 2013, p.48). The aim of IR is to provide insight the external environment that affects an organization, the resources and relationships used and affected by the organization (capitals) and the way in which the organization interacts with the external environment and capitals to create value.

According Hoesada (2015) integrated reporting is a report about how the organizations' strategies, governance, prospect, performance, and the external environment that are related to creating value for short, medium, and long term. Integrated reporting be prepared in accordance with the <IR> Framework created by IIRC (The International Integrated Reporting Council). Integrated reported should include eight element consist of: (1) organizational overview and external environment, (2) governance, (3) business model, (4) risk and opportunities, (5) strategy and resources allocation, (6) performance, (7) outlook, and (8) basis of preparations of presentations. These element related to each other and not mutually exclusive.

Integrated reporting requires the strong commitment of the CEO. He or she has the ultimate responsibility for the message the company is delivering to all of its stakeholders and for ensuring that it is a coordinated and consistent one. The decision to publish One Report can be made by the CEO, or it can be suggested by someone else in the company and then endorsed by the CEO (Eccles and Krzus, 2010, p.207).

Comparison Sustainability Report and Annual Report between Integrated Reports

Until now the company still presenting annual report and sustainability report separately. Annual report that emphasize financial report and be addressed to shareholders.



Financial report governed by certain bodies such as International Accounting Standard Board (IASB) in International Financial Reporting Standard (IFRS) as mandatory reporting. Sustainability report addressed to stakeholders and presenting in accordance with the guideline by Global Reporting Initiative (GRI) and usually as voluntary reporting. This separate report have no relation between one report and another report (Berndt et.al. in Adriana, 2015, p.3). Sustainability report are rarely used by investors as a basis for decision making.

Another relevant difference between IR and SR is that the approach proposed by the IIRC is based on the concept of “capital”, while the GRI is based on the concept of stakeholders. On the one hand, according to the IIRC framework, “capitals are stores of value that, in one form or another, become inputs to an organization’s business model. They are increased, decreased or transformed through the activities and outputs of the organization in that they are enhanced, consumed, modified, destroyed or otherwise affected by those activities and outputs” (IIRC in Busco et.al, 2013, p. 54). On the other hand, the GRI framework is mostly focused on stakeholders. The elements proposed by the GRI are in fact divided by aspect, thus divided into categories that are clearly inspired by the different stakeholders’ groups (economic, environmental, social, human rights, product responsibility, etc.).

IR is to be considered an evolution of AR rather than of SR, because the intended users of IR are clearly stated as the “providers of financial capital” (IIRC, 2013). In addition, the way in which IR frames the capitals (much more “objective” and centered on the firm, compared to the “subjective” stakeholder approach of SR) leads to the conclusion that IR is really an evolution of AR rather than of SR (Busco et.al, 2013, p.55).

RESEARCH METHOD

Population and Sample

The population in this research companies that had published Sustainability Report (SR) and listed on the Indonesian Stock Exchange (IDX) in 2015. Samples are determined by



using purposive sampling method. Based on the technique, this research obtained 39 companies.

Data Collection Technique

The data used are the data that can be directly measured or can be calculated more precisely, so that the data used are secondary data. The research method applied is quantitative research, while the data assessments are presented by using descriptive statistical analysis in tabular form the company's readiness categorization. The data analyzed in this study are secondary data from the annual report (AR) and sustainability report (SR) of each company that was published in 2015 calculated Mean Ideal (Mi) and ideal standard deviation (SDi). The tendency of data categorized into groups. The analysis uses 61 questions that reflect IR eight elements in the <IR> Framework.

According to Hadi (2016), the formula to determine Mi and SDi as follows:

$$Mi = [ST + SR]: 2$$

$$SDi = [ST - SR]: 6$$

Note:

Mi : The Ideal Mean

SDi : The Ideal Deviation Standard

ST : The Highest Ideal Score

SR : The Lowest ideal score

The number or value obtained from the formula calculation is categorized into groups as follows:

Well prepared : $X > Mi + 1.5 SDi$

Prepared : $Mi < X \leq Mi + 1.5 SDi$

Less prepared : $Mi - 1.5 SDi < X \leq Mi$

Unprepared : $< Mi - 1.5 SDi$



Operational Definition and Variable Measurement

Variables investigated in this study are readiness to implement the Integrated Reporting.

Annual Report and Sustainability Report

Annual report presented financial and non-financial reporting, financial data, governance, and corporate social responsibility. Annual report is mandatory reporting. The other report separate with annual report is sustainability report. Sustainability report as a disclosure that provides information to stakeholders about an organization's attempts to balance its economic, social and environmental goals. Sustainability report is voluntary reporting.

Content Element of Integrated Reporting

An integrated report is a concise communication about how an organization's strategy, governance, performance and prospects, in the context of its external environment, lead to the creation of value over the short, medium and long term. The aim of IR is to provide insight the external environment that affects an organization, the resources and relationships used and affected by the organization (capitals) and the way in which the organization interacts with the external environment and capitals to create value.

RESULT AND DISCUSSION

Result

The research developed a checklist based on <IR> Framework and use this to analysis of the annual report and the sustainability report of a sample, which is related with the content elements of integrated reporting. The Measurement of readiness implementation of integrated reporting of the companies was done by calculating the mean values for each content element of integrated reporting, and from the average classified in accordance with the assessment categories, categorized as well prepared, prepared, less prepared and



unprepared. There are eight contents element of integrated reporting tested and used total 61 indicators based on the elements. The discussion on the findings are outlined as follows:

Organizational Overview and External Environment

Organizational overview and external environment identifies the organization's mission and vision, and provides essential context by identifying matters such as the organization's culture, ethics, value, ownership and operating structure, principal activities and markets positioning, position within the value chain, key qualitative information, and significant factors affecting the external environment and organization's response. The checklist based on this element used 18 indicators.

The readiness implementation of integrated reporting can be identified in table 1 as follows:

Table 1. The Categorization of Readiness Implementation of Integrated Reporting based on Organizational Overview and External Environment

No.	Category	Span	Amount	Percentage
1	Well Prepared	> 13	13	33%
2	Prepared	10 – 13	12	31%
3	Less Prepared	7 – 10	11	28%
4	Unprepared	< 7	3	8%
	Total		39	100%

The table showed that 60% companies were ready to implement the element, which are 33% or 13 companies categorized as well prepared and 12 companies or 31% with range 10 – 13 categorized as prepared. It means that 25 companies have met almost all the indicators in element organizational overview and external environment. On the other hand, only 3 companies or 8% with range < 7 indicators categorized as unprepared.



Governance

Governance provides insight about how such matters as the following are linked to its ability to create value: the organization's leadership structure, specific processes used to make strategic decisions and to establish and monitor the culture of the organization, and the organization's governance structure support its ability to create value in the short, medium, and long term. The checklist based on this element used 9 indicators.

The readiness implementation of integrated reporting can be identified in table 2 as follows:

Table 2. The Categorization of Readiness Implementation of Integrated Reporting based on Governance

No.	Category	Span	Amount	Percentage
1	Well Prepared	> 8	1	3%
2	Prepared	6 – 8	13	33%
3	Less Prepared	4 – 6	19	49%
4	Unprepared	< 4	6	15%
	Total		39	100%

The results showed that 19 companies or 49% with range 4 – 6 categorized as less prepared and 6 companies or 15% with range < 4 categorized as unprepared. It can be said that more than 60% companies had not fulfill the indicators yet. Only 1 (one) company categorized as well prepared.

Business model

An organization's business model is its system of transforming input, through its business activities, into output and outcomes that aims to fulfil the organization's strategic purposes and create value over short, medium, and long term. The checklist based on this element used 6 indicators.

The readiness implementation of integrated reporting can be identified in table 3 as follows:



**Table 3. The Categorization of Readiness Implementation of Integrated Reporting
based on Business Model**

No.	Category	Span	Amount	Percentage
1	Well Prepared	> 5	1	3%
2	Prepared	3 – 5	6	15%
3	Less Prepared	1 – 3	14	36%
4	Unprepared	< 1	18	46%
	Total		39	100%

It can be seen from the table above that 14 companies or 36% with range 1 – 3 indicators categorized as less prepared and 18 companies or 46% with range < 1 indicators categorized as unprepared. It means that more than 80% companies are not ready to implement governance element. However, only 1 (one) company or 3% categorized as well prepared.

Risk and opportunities

An integrated report identifies the key risk and opportunities that are specific to the organization, including those that relate to the organization's effect on, and the continued availability, quality and affordability of, relevant capitals in short, medium, and long term. The checklist based on this element used 6 indicators.

The readiness implementation of integrated reporting can be identified in table 4 as follows:

**Table 4. The Categorization of Readiness Implementation of Integrated Reporting
based on Risk and Opportunities**

No.	Category	Span	Amount	Percentage
1	Well Prepared	> 4	6	15%
2	Prepared	3 – 4	8	24%
3	Less Prepared	1 – 3	23	59%
4	Unprepared	< 1	2	5%
	Total		39	100%



It can be seen from the results that 23 companies or 59% with range 1 – 3 indicators categorized as less prepared and 2 companies or 5% with range < 1 categorized as unprepared. It show more than 60% companies not ready to implementing this element. In the contradiction, 6 companies or 15% categorized as well prepared.

Strategy and Resource Allocation

An integrated report ordinary identifies: the organization's short, medium and long term strategic objectives, the resource allocation plans it has to implement its strategy, and how it will measure achievements and target outcomes for the short, medium, and long term. The checklist based on this element used 7 indicators.

The readiness implementation of integrated reporting can be identified in table 5 as follows:

Table 5. The Categorization of Readiness Implementation of Integrated Reporting based on Strategy and Resource Allocation

No.	Category	Span	Amount	Percentage
1	Well Prepared	> 4	3	8%
2	Prepared	3 – 4	3	8%
3	Less Prepared	1 – 3	13	33%
4	Unprepared	< 1	20	51%
	Total		39	100%

The results showed that 13 companies or 33% with range 1 – 3 categorized as less prepared and 20 companies or 51% with range < 1 categorized as unprepared. It show more than 80% companies not ready to implementing this element.

Performance

An integrated report contains qualitative and quantitative information about performance that may include matter such as: qualitative indicators with respect to target and risk and opportunities, the organization's effects on the capital, the state of key stakeholder



relationship, and the linkages between past and current performance, and between current performance and the organization's outlook. The checklist based on this element used 5 questions.

The readiness implementation of integrated reporting can be identified in table 6 as follows:

Table 6. The Categorization of Readiness Implementation of Integrated Reporting based on Performance

No.	Category	Span	Amount	Percentage
1	Well Prepared	> 4	2	5%
2	Prepared	3 – 4	1	3%
3	Less Prepared	1 – 3	26	65%
4	Unprepared	< 1	11	28%
	Total		39	100%

Table 6 showed that 26 companies or 65% with range 1 – 3 categorized as less prepared and 11 companies or 28% with range < 1 categorized as unprepared. It means that more than 90% companies had not meet the indicators yet.

Outlook

An integrated report lights anticipated changes over time provides information, built on sound and transparent analysis, about: the organization's expectations, how that will affect the organization, and how the organization is currently to the critical challenges and uncertainties that are likely to arise. The checklist based on this element used 6 indicators.

The readiness implementation of integrated reporting can be identified in table 7 as follows:



Table 7. The Categorization of Readiness Implementation of Integrated Reporting based on Outlook

No.	Category	Span	Amount	Percentage
1	Well Prepared	> 4.5	4	10%
2	Prepared	3 – 4.5	13	33%
3	Less Prepared	2 – 3	9	23%
4	Unprepared	< 2	13	33%
	Total		39	100%

According to the table 7, 17 companies or 43% categorized as prepared or they can fulfill more than 5 indicator of this element. On the other hand, 22 companies categorized as less prepared and unprepared which means that they only fulfill less than 3 indicators.

Basis of Preparation of Presentation

An integrated report describes its basis of preparation and presentation, including: a summary of the organization's materiality determination process, a description of the reporting boundary and how it has been determined, and a summary of the significant frameworks and methods used to quantify or evaluate material matters. The checklist based on this element used 4 indicators.

The readiness implementation of integrated reporting can be identified in table 8 as follows:

Table 8. The Categorization of Readiness Implementation of Integrated Reporting based on Basis of Preparation of Presentation

No.	Category	Span	Amount	Percentage
1	Well Prepared	> 1	0	0%
2	Prepared	0 – 1	15	38%
3	Less Prepared	≤ 0	24	62%
4	Unprepared	-	-	-
	Total		39	100%



Table 8 shows 24 companies or 62% with range ≤ 0 categorized as less prepared. It show more than 60% companies not ready to implement this element. No company or 0% categorized as well prepared.

Content Element

The readiness implementation of integrated reporting can be identified in table 9 as follows:

Table 9. The Categorization of Readiness Implementation of Integrated Reporting based on All of Content Element

No.	Category	Span	Amount	Percentage
1	Well Prepared	> 35	12	31%
2	Prepared	28 – 35	9	23%
3	Less Prepared	21 – 28	10	26%
4	Unprepared	≤ 21	8	21%
	Total		39	100%

Overall, based on 8 elements consists of 61 indicators on Integrated Reporting, the results can be seen from the table are :

1. 12 companies or 31% with a range of >35 (fulfilled more than 35 indicators) categorized as well prepared.
2. 9 companies or 23% with a range of 28 - 35 categorized as prepared
3. 10 companies or 26% with a range of 21 - 28 categorized as less prepared
4. 8 companies categorized as unprepared or 21% with a range of ≤ 21 .

In conclusion, less than 50% or 12 companies out of 39 samples are ready to apply The Integrated Reporting, which are BFI Finance Indonesia Tbk, Bank Pembangunan Jawa Barat dan Banten Tbk, Bank Pembangunan Jawa Timur Tbk, Bank Permata Tbk, Vale Indonesia Tbk, Indika Energy Tbk, Indo Tambangraya Megah Tbk, Bank OCBC NISP Tbk, PP (Persero) Tbk, Telekomunikasi Indonesia (Persero) Tbk, Total Bangun Persada Tbk, and United Tractors Tbk.



Based on that 12 companies, all of companies categorized as well prepare in four elements, are organizational overview and external environment, governance, risk and opportunities, and performance. In business model element, 83.3% or 10 companies categorized as well prepared and 16.67% or 2 companies categorized as prepared. In strategy and resource allocation element, 67% or 8 companies categorized as well prepared, 8% or 1 company categorized as prepared, and 25% or 3 companies categorized as unprepared. In outlook element, 92% or 11 companies categorized as well prepared and 8% or 1 company categorized as prepared. Different with others elements, in basis of preparation and presentation , 50% or 6 companies categorized as prepared and 150% or 6 companies categorized as less prepared. No companies categorized as well prepared.

CONCLUSION

All in all, it was found that: 31% companies categorized as well prepared to implement the Integrated Reporting, Furthermore 23% companies categorized as prepared to implement the Integrated Reporting, however 26% companies categorized as less prepared to implement the Integrated Reporting, whereas 21% companies categorized as unprepared to implement the Integrated Reporting.

Some limitations are found in this research including: (1) the number of sample in this research was only 39 companies, so there is possibility that the result do not reflect the condition in Indonesian companies, (2) the subjectivity of providing checkmark in checklist to determine whether the companies disclose the indicators of integrated reporting. Therefore, it is necessary to work together with practitioners to minimize the subjectivities.

REFERENCES

- Adriana. (2015). *Analisis Kesiapan menerapkan Integrated Reporting pada Indeks LQ-45* (unpublished magister thesis). Universitas Gadjah Mada, Indonesia.
- Busco, C., Frigo, M.L., Riccaboni, A., & Quattrone, P. (2013). *Integrated Reporting Concepts and Cases that Redefine Corporate Accountability*. Switzerland: Springer.
- Davis, Stephen, & Lukomnik, Jon. (2012, March). Integrated Reporting's Effect on Disclosure. *Board & Shareholders*, 44-45.



- Eccless, Robert G., & Krzus, Michael P. (2010). *One Report: Integrated Reporting for a Sustainable Strategy*. Hoboken, New Jersey: John Willey & Sons.
- Eccles, Robert G., & Saltzman, Daniela. (2011). Achieving Sustainability through Integrated Reporting. *Stanford Social Innovation Review, summer 2011*, 56-61.
- GRI. (2011). *Sustainability Reporting Guidelines, Version: 3.1*. Amsterdam: Global Reporting Initiative.
- Hadi, Sutrisno. (2016). *Metodologi Riset*. Yogyakarta: Pustaka Pelajar.
- Hoque, M. Enamul. (2017). Why Company Should Adopt Integrated Reporting? *International Journal of Economics and Financial Issues*, 7(1), 241-248.
- IIRC (The International Integrated Reporting Council). (2013). *The International <IR> Framework*. London: International Integrated Reporting Committee, IIRC.
- Jensen, J. Catharina, & Berg, Nicola. (2011). Determinants of Traditional Sustainability Reporting Versus Integrated Reporting, an Institutional Approach. *Business Strategy and the Environment*, 1-18.
- Hoesada, Jan. (2015). *Cetak Biru Laporan Terintegrasi*. Retrieved from <http://crmsindonesia.org/crms-articles/cetak-biru-laporan-terintegrasi-part-1>
- Robertson, Fiona A., & Samy, Martin. (2015). Factors affecting the diffusion of integrated reporting – a UK FTSE 100 perspective. *Sustainability, Accounting, Management, and Policy Journal*, 6(2), 190-223.
- Tudor-Tiron, Adriana, & Dragu, Ioana. (2014). From Sustainability to Integrated Reporting – The Political Perspective of Institutional Theory. *Studia Universitatis Babeş-Bolyai Oeconomica* 59(2), 20-33.



CREATIVE CITY: ANALYSIS OF BANDUNG CREATIVE CITY INDICATORS

Mohammad Benny Alexandri

Universitas Padjadjaran Bandung

bennyalexandri@yahoo.co.id

Abstract

United Nations Development Programme (UNDP) and the United Nations Conference on Trade and Development (UNCTAD) published the Creative Economy Report 2008. A wave of global research on the concept / term creative economy, creative industries, creative cities and creative culture since that time.

The process of internationalization of the creative economy become popular when The Martin Prosperity Institute (MPI) an international think-tank organization released The Global Creativity Index (GCI) GCI in 2010.

The document contains index measuring creativity and assess the ranking of creativity throughout the country. Referring to the GCI report in 2011, the index of creativity country Indonesia is ranked 81 of 82 countries with an index value of 0.037 creativity. The main challenge of creative economic development over the last 10 years is how to assess and measure the level of creativity in the State, provincial and districts or cities.

Assessment and measurement of creativity depends on understanding of the indicators of creativity town for example.

This study objective is creating the indicators of Bandung as a Creative City by combining the indicators used in other town in the world with creativity indicators Bandung that already exists.

The purpose of doing this study is to formulate indicators concerning the establishment of Bandung as a Creative City that is supported by the performance of the creative industries in Bandung.

The output of this study is the assessment of the performance of the achievements of each indicator in Bandung Creative City.

The results of the study is Bandung as a creative city in design field.



Keywords: *Creative City, Creative Industries, Indicators*

JEL Classification: *R11*

INTRODUCTION

Creative economy is become more popular for some countries today. The awareness of the exhaustion of a resource will encourage people to more creative to improve for economy in minimal resources.

In 1997-2000 study period, the percentage of the GDP contribution of the creative industries in several countries were 2.8% (Singapore) to 7.9% (the UK) 5.7% (Australia) 16% (the UK), and the employment rate were 3.4% (Singapore) to 5.9% (US) of total employment in the country.

Based on the creative industry mapping conducted by the Ministry of Commerce of the Republic of Indonesia, the creative industry in Indonesia has donated GDP to 104.73 trillion rupiah, or accounted for 6.28% of the total GDP of Indonesia. The average GDP growth 2003-2006 period is only 0.74% which was caused by declined in contributions subsector crafts and fashion in 2002-2003 and 2005-2006.

The export value of the creative industries in Indonesia in 2006 reached 81.4 trillion and accounted for 9.13% of the total value of national exports.

The results of this study, it can be concluded that the creative industries sector in Indonesia, was also a promising industrial sector to support the growth of the Indonesian economy.

The typical of the creative economy are creativity, culture, heritage, and environment. Creative economy is triggered due to the creative industries are industries that are creating activities, knowledge, products, and services which are original, such as proposed by UNESCO (2003) (Erni R.Ernawan (2009).

The purpose of this study are:

1. How the creative economy in Bandung City.
2. What creative economy indicators used Bandung City
3. What sub-sector can be used as icon of Bandung City



DISCUSSION

Creative economy is "economic activity which their input and output is the idea, in which the idea will raises a lot of creativity that will gives a lot of revenue." (Howkins (2007))

In many countries, creative economy is the most important contribution in increasing the rate of economic growth and will improve social welfare. The new ideas and creativity will make inventions and innovations to grow and develop rapidly. In telecommunications and computer industries, it development very fast not in years, but in months will produce new products with better features, effectively and efficiently.

Howkins (2007), creativity is not always an economic activity but it can generate ideas in economic implications or products that can be traded. In general, changes occur when ideas are identified, named, and made more practical so it can be held, enjoyed and traded.

In general, the creative economic will impact the creative industry at least in seven elements of the economy, which are:

1. Contributions Economy
2. Business
3. Social Impacts
4. Image
5. Communication
6. Innovation And Creativity

In general, the strong reason why the creative industries need to be developed, is because of the creative industries sector has a significant economic contribution to the Indonesian economy; it can create a business climate which is positive.

It can strengthen the image and identity of the Indonesian nation, support the use of renewable resources, is central the creation of innovation and creativity formation, and have a positive social impact.

Howkins (2007) suggested that for the growth and development of the creative industries, it should be harmonization of the Talents , Tolerance (among people and Technology (3T).



The Ministry of Commerce of the Republic of Indonesia (2007) "The activities of the Indonesian creative industry has not managed through policy, legally and institutionally, is suspected of impact on different areas of development, including the economic field.

The magnitude of the impact of the creative industries on the Indonesia's economy , uses several indicators used to measure the creative industries (Ministry of Commerce of the Republic of Indonesia (2007), namely:

1. Gross Domestic Product (GDP);
2. Employment;
3. Activities of the Company
4. Impact on other sectors

Creative Industry in Bandung

Creative industries in the city based on KUKM data in 2013 ago, the amount was as much as in 1078 the business group distributed into 15 categories of creative industries. It shows that in East Bandung (Region Gedebage) tend to spread a little more creative industries. The creative industrial map more concentrated in center of the city, which is closely related on the center of the economic rotation in Bandung.

Districts with the highest number of creative industries is in Cibeunying Kidul, Babakan Ciparay, Lengkong and Bojongloa Kidul (over 60 industrial businesses). While in Bandung Kulon, Regol, Rancasari, Coblong, Antapani, Bojongloa Kaler, Bandung Wetan and Sukajadi is between 40 to 60 industrial enterprises).

Most types of creative industry is the craft industry, fashion, culinary, advertising and TV & Radio industry. While other types of creative industries is still limited below 10 business units in the district



Table 1. Number of Creative Industry per Sub District

Industry's Type	Q
Architect	3
Design	24
Fashion	205
Kraft	488
Culinary	153
Computer Service and Software	7
Music	3
Market And Art Goods	21
Publishing & Printing	9
Advertising	93
Interactive games	1
Research & Development	1
Performing Arts	2
TV And Radio	61
Video, Film & Photography	7
Total Per Sub District	1078

Department of Commerce (2007) there are several directions of development of the creative industry, the development of a focus on industry-based: (1) cultural creative industry; (2) the creative industry, or (3) Intellectual property rights such as copyright.

The Bandung has set for her indicators which are; 1) Creative Policy; 2) Creative Infrastructure; 3) Legal, Ethical and Intellectual Property; 4) Creative Support System; 5) Creative Capacity; and 6) The economic contribution.

Selected indicators have the following definitions:

1. Creative policy, the rules and regulations that are supporting citizens, businesses, industry and creative economy that makes creative city.



2. Creative infrastructure, namely infrastructure and facilities in the city that allows its citizens do creative activities
3. The law, ethics and copyright, which are rules and attitudes that support creative entities in conducting its activities
4. Creative Support System, which is a supporting case in the form of technology and innovation that support people to become creative
5. Creative capacity and economic contribution, namely the ability of human resources and economic outcome for the citizens with their creative city

During her development, the city of Bandung has plan to put herself as a UNESCO Creative City. It has been initiated by the city of Bandung and its stakeholders since 2012. In 2015, the city of Bandung is planning to become as a UNESCO Creative City Networks and has been endorsed by the Decision of the Mayor of Bandung, Mr. Ridwan Kamil.

UNESCO's Creative Cities Network is a collaboration of four parties will realize the Creative City and has a strong effect for the community, particularly in lifting the economic contribution of society.

All pairwise comparisons of data to factor capability of the company is shown in the following table:

Table 2. Total Grade for Creative Industry Sub Sectors

N	Factors	Grade	Design	Fashion	Culinary	Kraft
1	Contribution	17%	1%	6%	5%	5%
2	Event	15%	2%	10%	4%	1%
3	City Programs	15%	12%	2%	2%	1%
4	Education Institution	15%	12%	2%	2%	2%
5	Event Facilities	13%	7%	3%	1%	7%
6	City Network	13%	4%	10%	2%	1%
7	City Policies	13%	8%	6%	2%	1%
	TOTAL	100%	45%	39%	16%	18%

The total value of the evaluation of UNESCO Creative City value multiplied by the weight indicates that the value of 45% for design, 39% for Fashion, and 16% for the Culinary and 18% for Craft.

It can be concluded that **Design** as selected sub-sector with the highest value of 45%. The calculation was using AHP (Analytical Hierarchy Process) Program.

Table 3. Achievement Parameter Creative City

N	Parameters	Point	%	Category
1	Economic achievement	7	70.00	High
2	Events	4	40.00	Low
3	Educational institutions	8	80.00	High
4	Creative space	5	50.00	Middle
5	Facilities	5	50.00	Middle
6	Cities Program	7	70.00	High
7	Government Policy	7	70.00	High
8	Other Supporting Policies	6	60.00	Middle
9	Cooperation cities	6	60.00	Middle
10	networking facilities	6	60.00	Middle
		10		

Table 4. Average Achievement Parameter Creative City

No	Parameter	%	Category
1	Average	61.00	Average

The parameters used to measure the achievement of indicators show that, in general, is in the position is average or "moderate". This indicates there are still many things to be prepared by the city of Bandung in order to achieve the title as Creative City.

CONCLUSION

1. Bandung is using 6 (six) indicators for their Creative city's indicators
2. The Indicators are 1) Creative Policy; 2) Creative Infrastructure; 3) Legal, Ethical and Intellectual Property; 4) Creative Support System; 5) Creative Capacity; and 6) The economic contribution
3. Sub sector chosen for Bandung is design based on calculation
4. Average achievement for the parameter used as design creative city is average or moderate
5. This indicates there are still many things to be prepared by the city of Bandung in order to achieve the title as Creative City.

REFERENCES

- Bank Indonesia (2015) Kajian Peningkatan Akses Pembiayaan Bagi Industri Kreatif Di Indonesia Sektor Industri Kerajinan
- Howkins, John. 2002. *The Creative Economy: How People Make Money from Ideas*. London: Penguin Press.
- Landry, C. dan Bianchini, F. 1995. *The Creative City*. Bournes Green: Comedia.
- Pengembangan Industri Kreatif Menuju Visi ekonomi Kreatif Indonesia 2025, (2008) Departemen Perdagangan Republik Indonesia



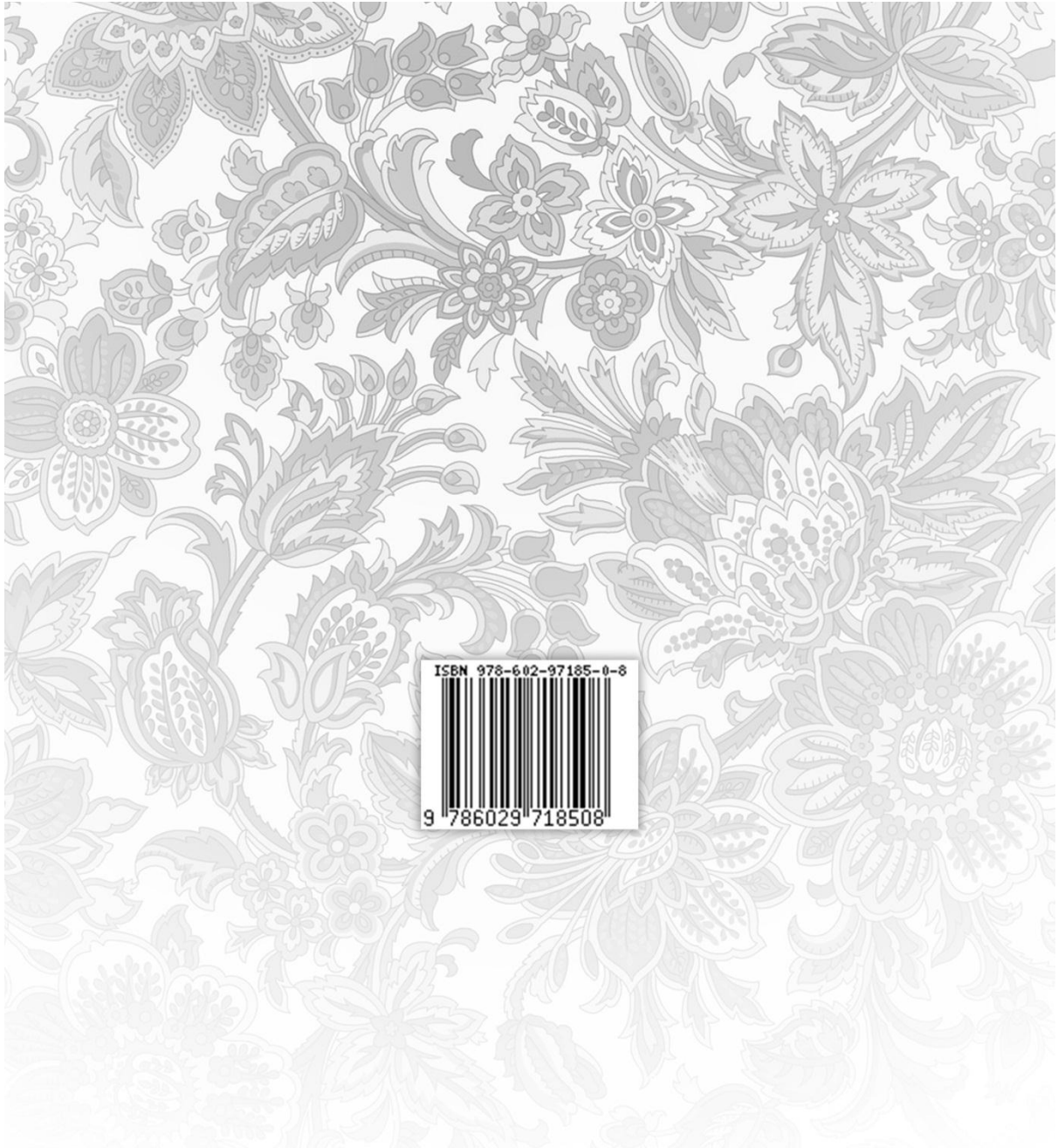

ISBN 978-602-97185-0-8



9 786029 718508

PROCEEDING

3rd PARAHYANGAN INTERNATIONAL ACCOUNTING AND BUSINESS CONFERENCE

“THE FUTURE OF ACCOUNTING AND BUSINESS
IN RAPID DEVELOPMENT OF INFORMATION TECHNOLOGY”